



CREATOR

7345



1

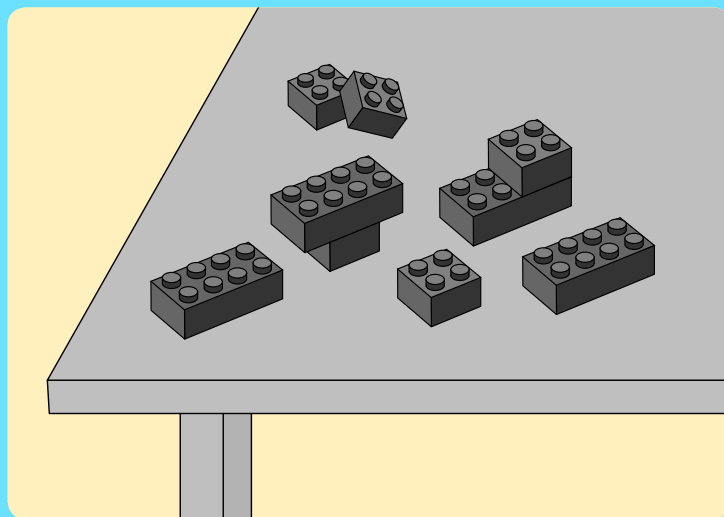
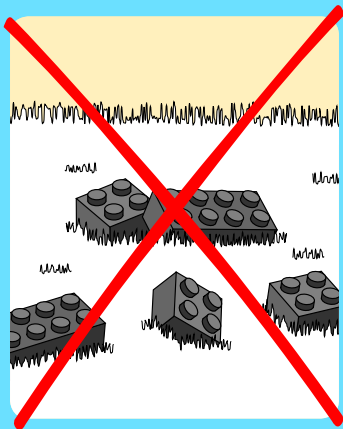

2

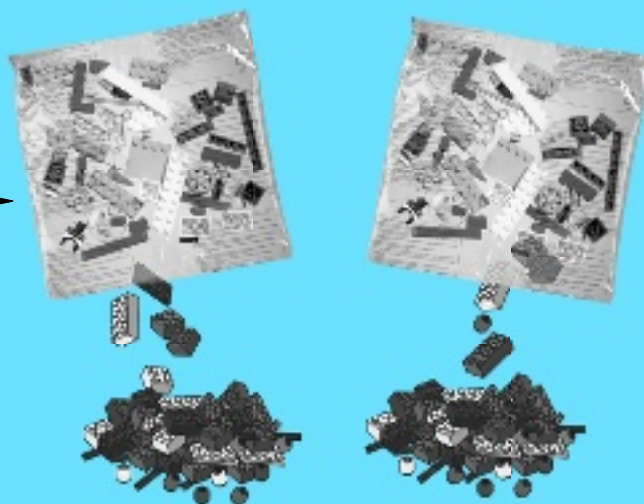



Quick Build Construction Facile

Anfängermodelle
Construcción rápida
Construção Rápida
Egyszerűen és gyorsan -
kezdőknek



Medium Build Construction moyenne

Fortgeschrittenenmodelle
Construcción
de nivel intermedio
Construção
Intermédia
Egyszerűen
és gyorsan - gyakorlóknak



Advanced Build Construction avancée

Profimodelle
Construcción de nivel avanzado
Construção Avançada
Egyszerűen és gyorsan -
tapasztalt építőknek





2x

1



1x



1x

2



4



2x



1x

3



1x

4

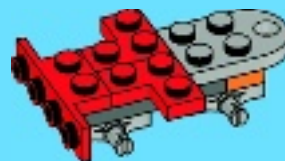



2x

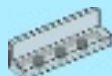

1x

5



2x



1x

6



1x



2x

7



4x



4x

8



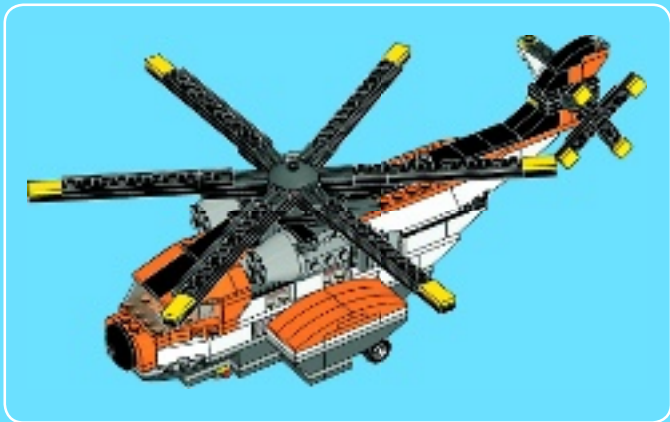

2x



1x

1



2x



2x

2



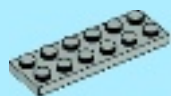

2x

3



2x

4

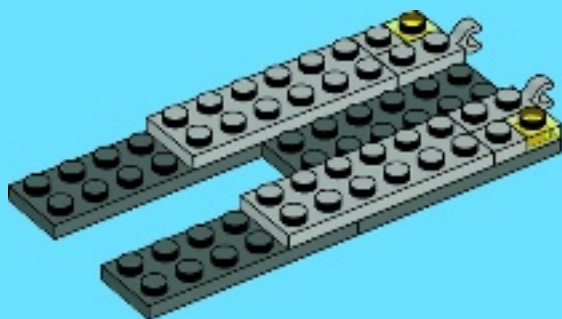



5

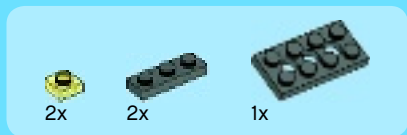
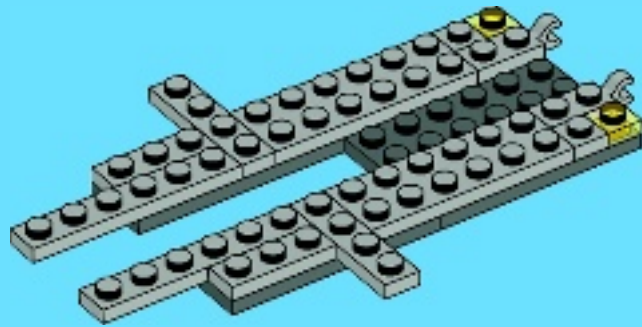

6

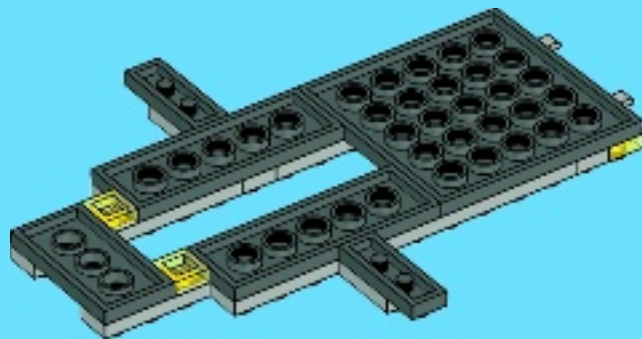



2x



1x



2x

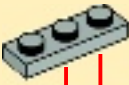

2x



2x

7

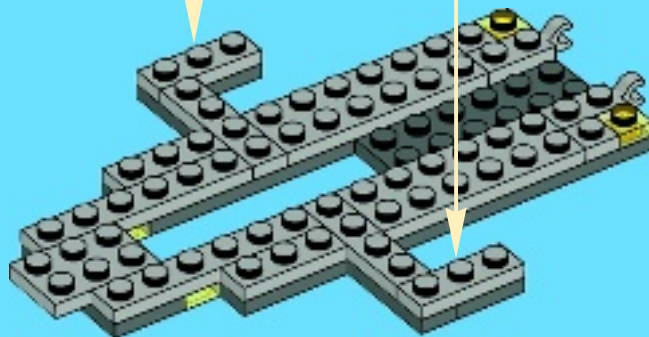

2x



2x

8

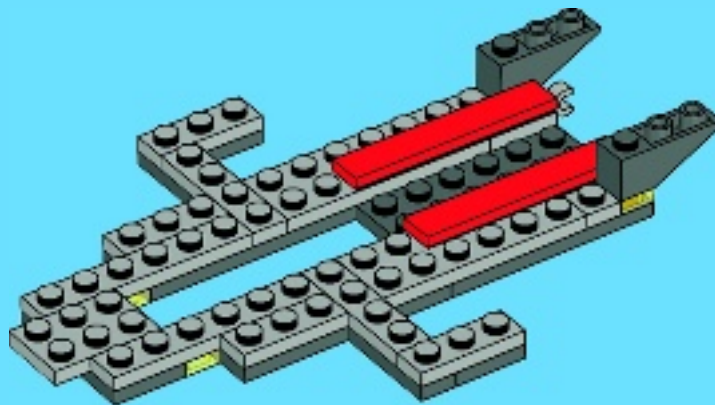

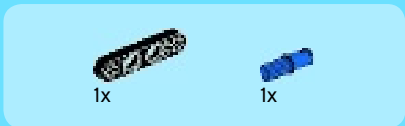

1

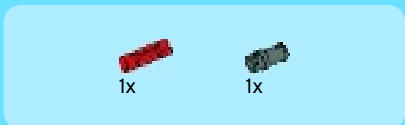
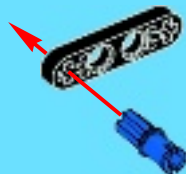

2

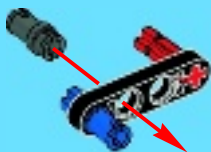

3

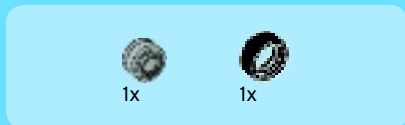
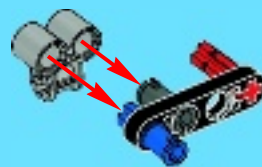

4

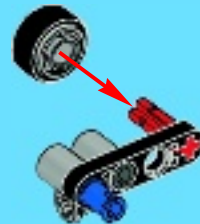



1x

5

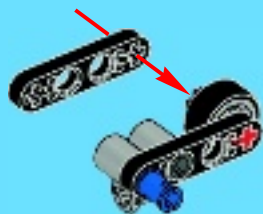

1x

6

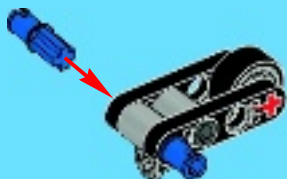

1x



2x



1x

7

1

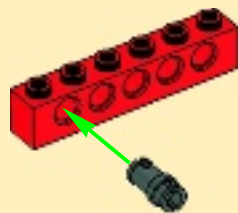

2

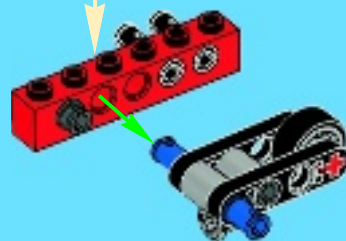
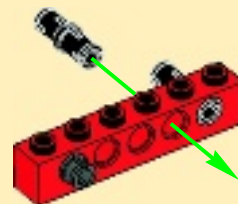



8

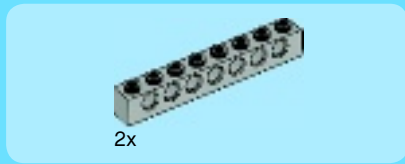
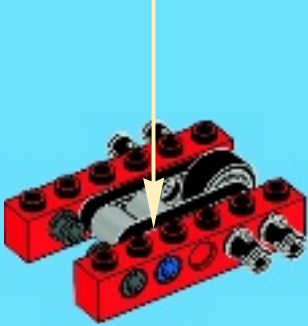
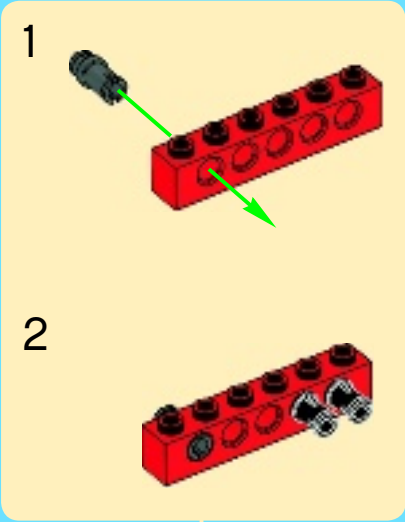

9





2x

10

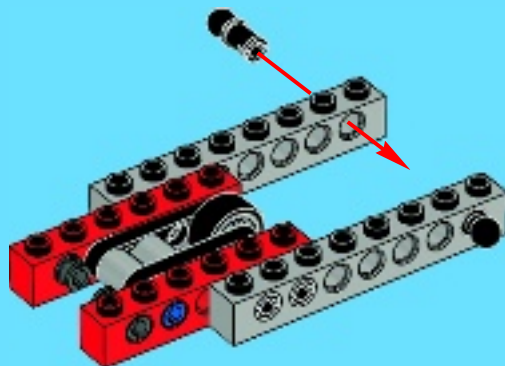

11

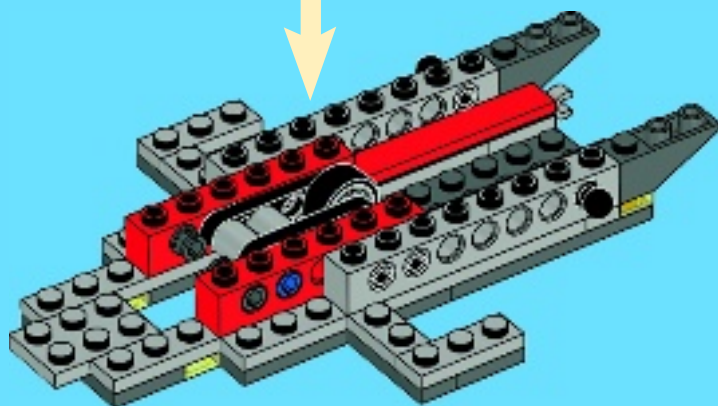



1x



1x



2x

12

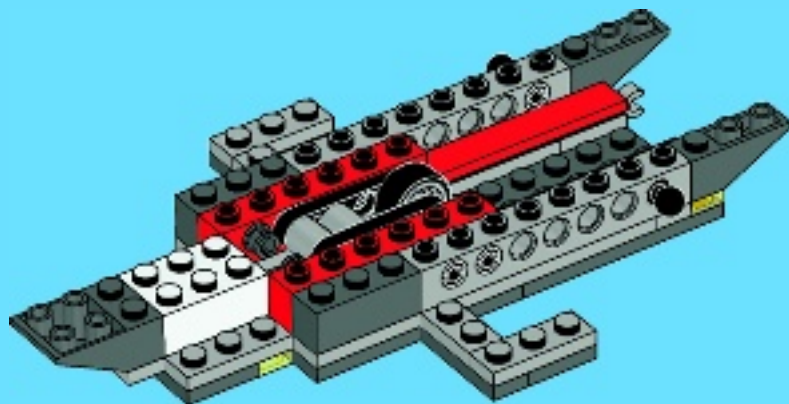

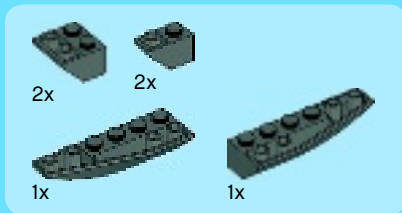

13

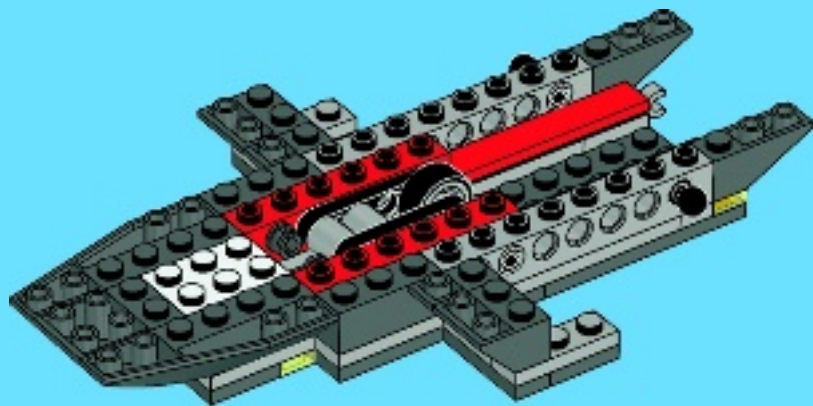



2x



2x



2x

14

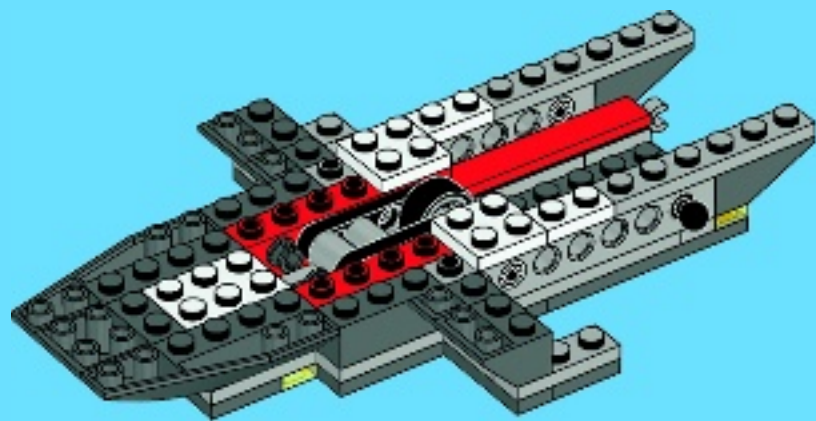

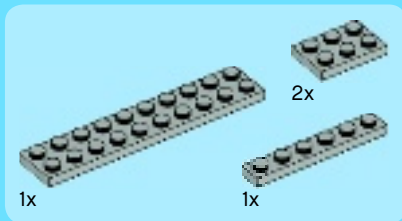

15

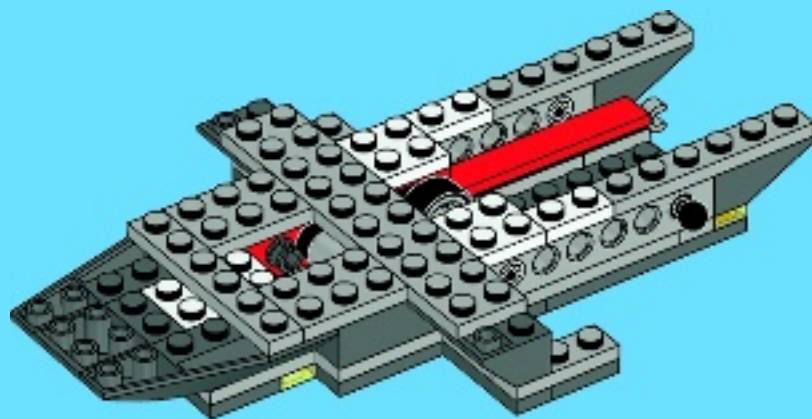



16

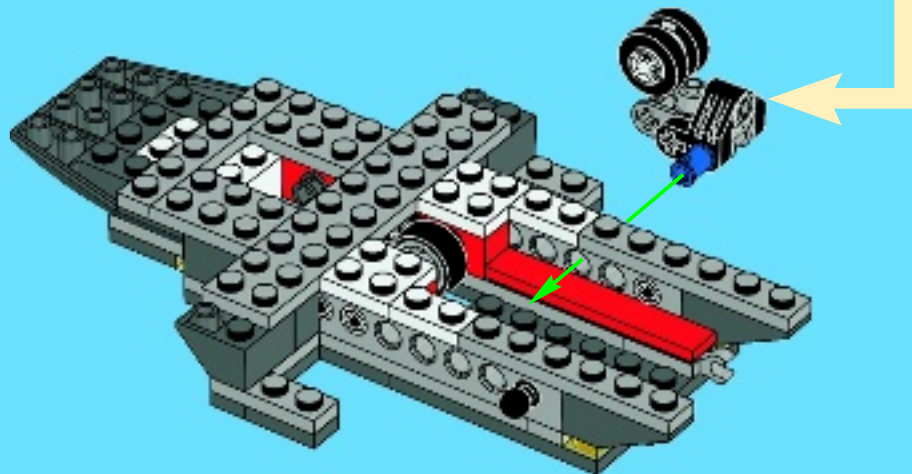
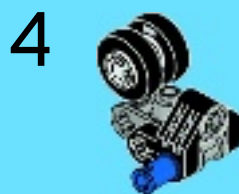
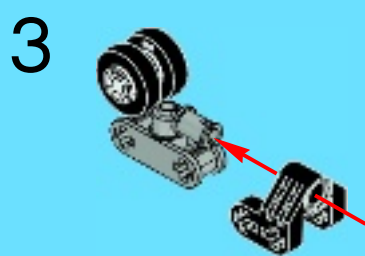
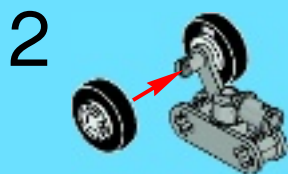
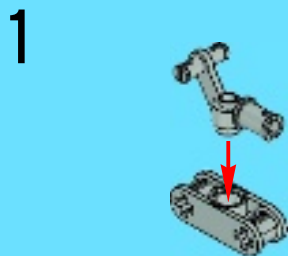



2x



2x



1x



1x



1x



1x

17

1

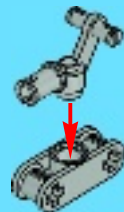

2

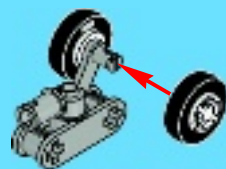

3

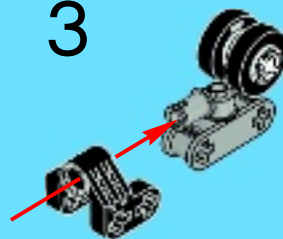

4

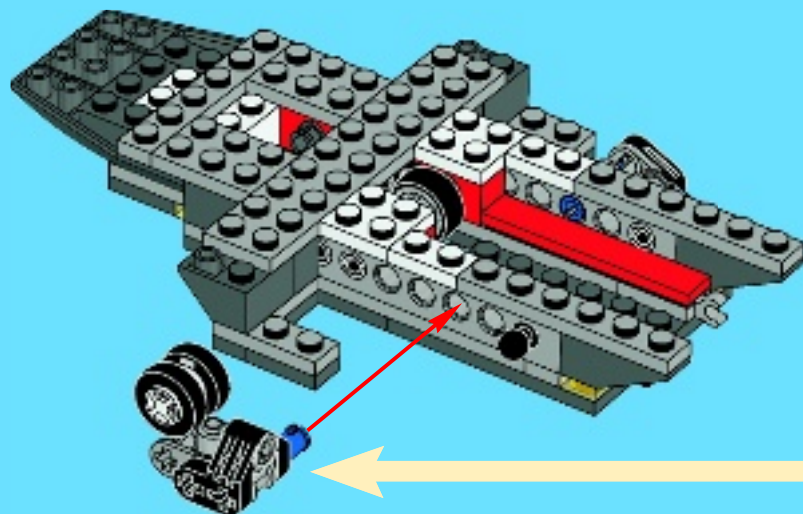



2x

18

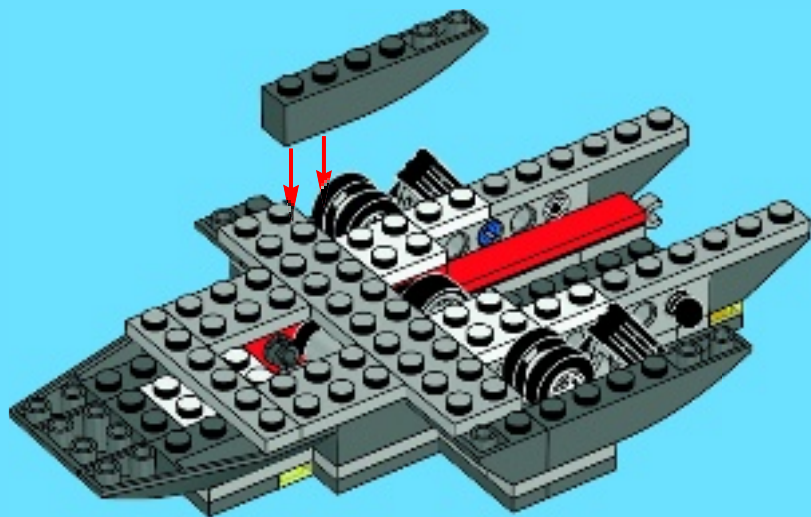



1x



2x



1x



1x

19

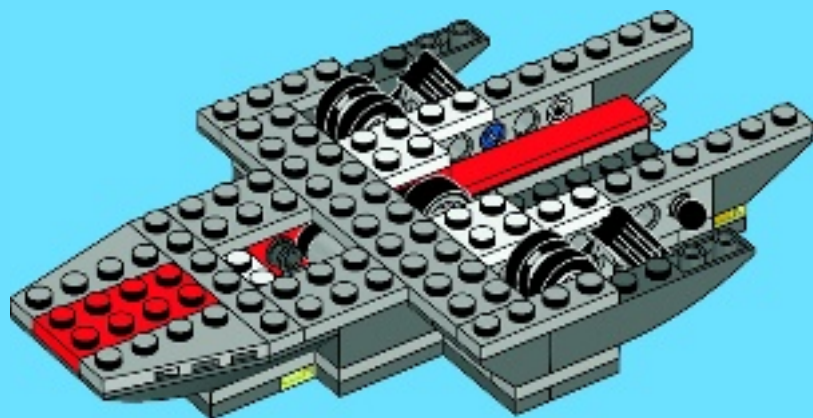



2x



2x



2x

20

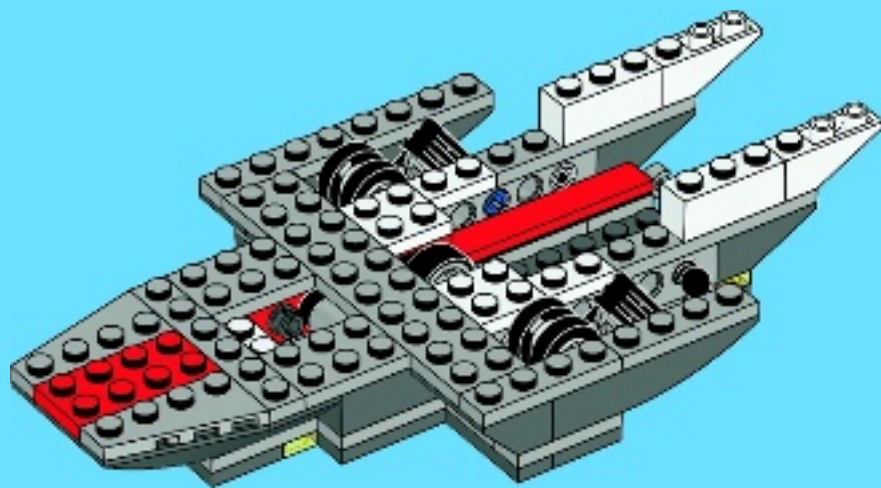

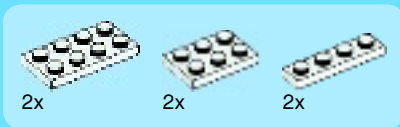

21

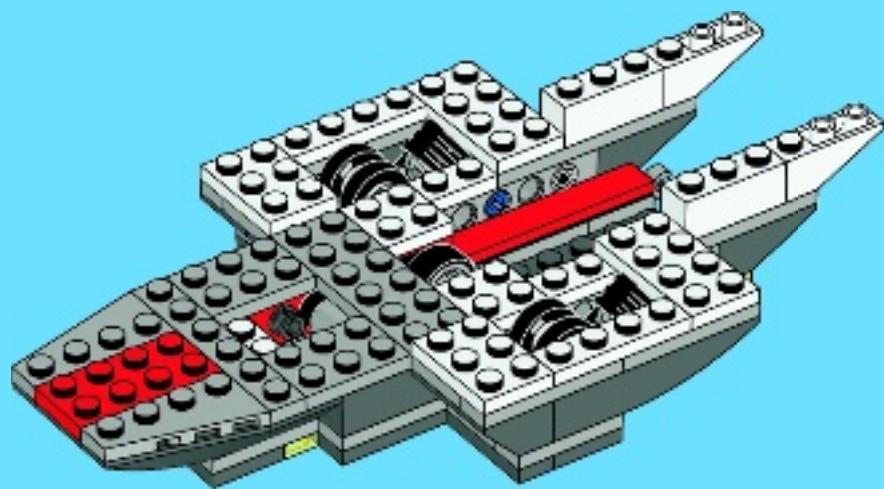



2x



2x



2x



2x

22

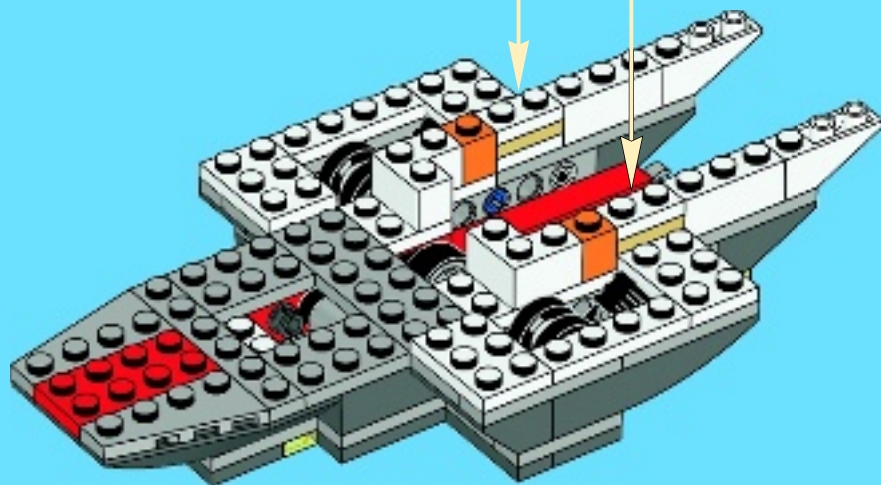
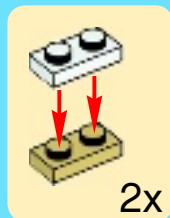



2x



2x



2x

23

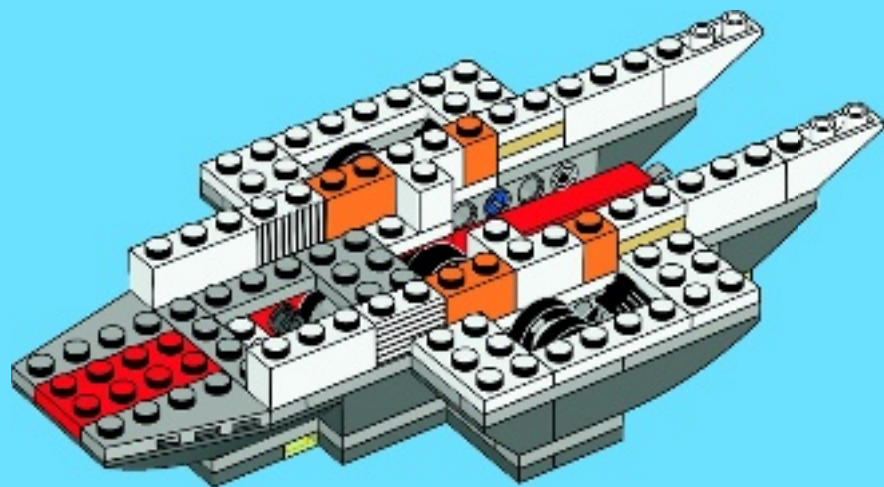



1x



1x



1x

24

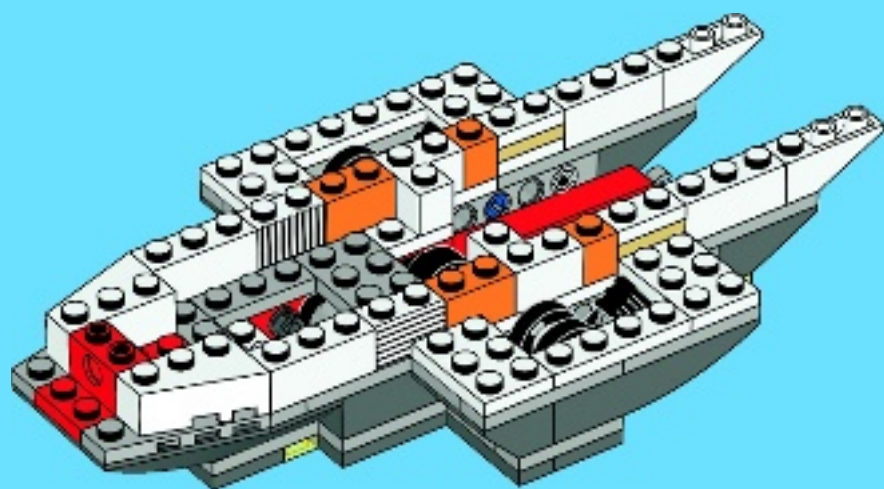



2x



1x



1x



1x

25

1

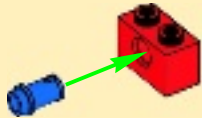

2

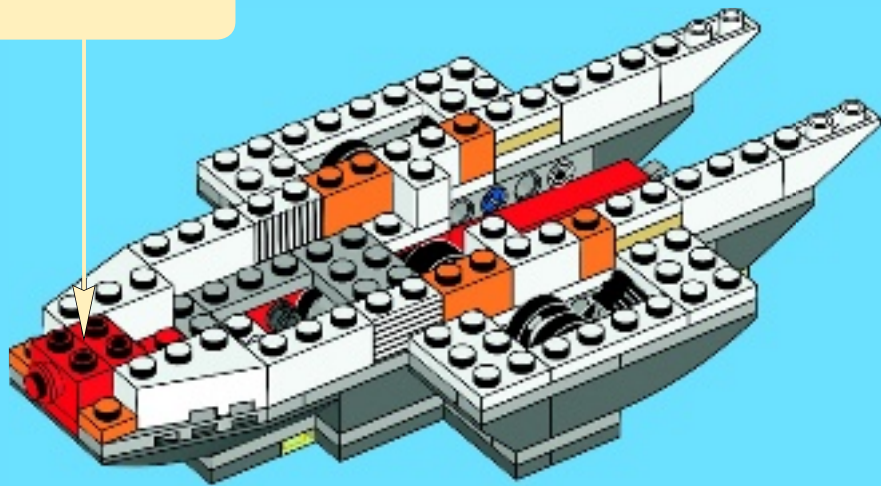
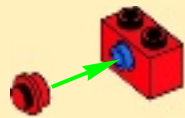

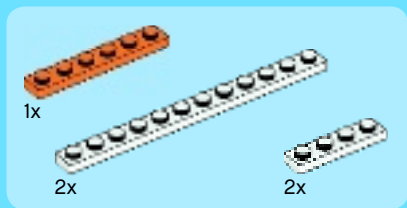

26

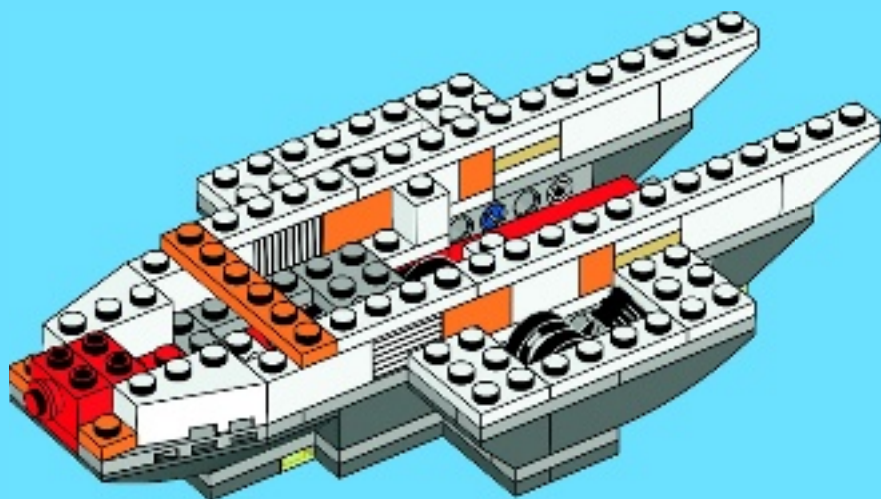



1x



2x



1x



1x

27

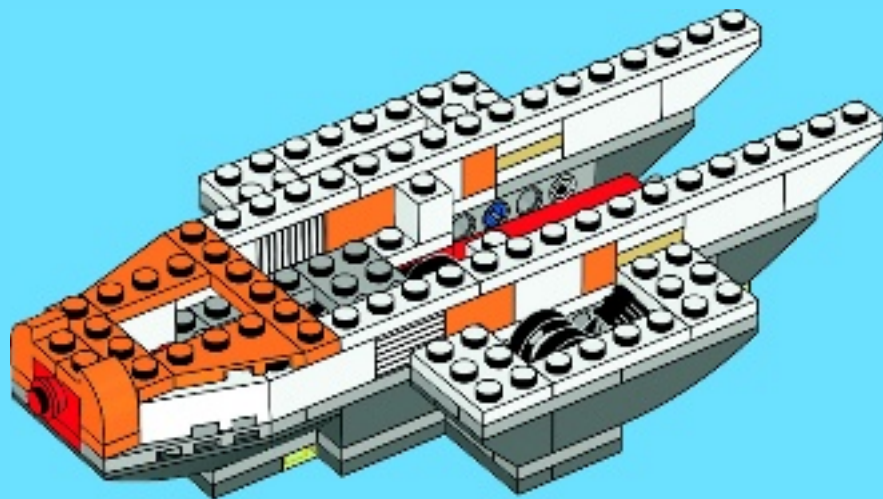

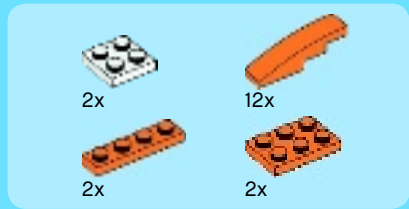

28

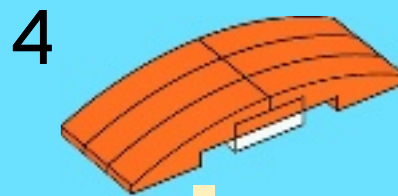
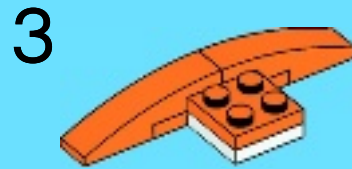

2x

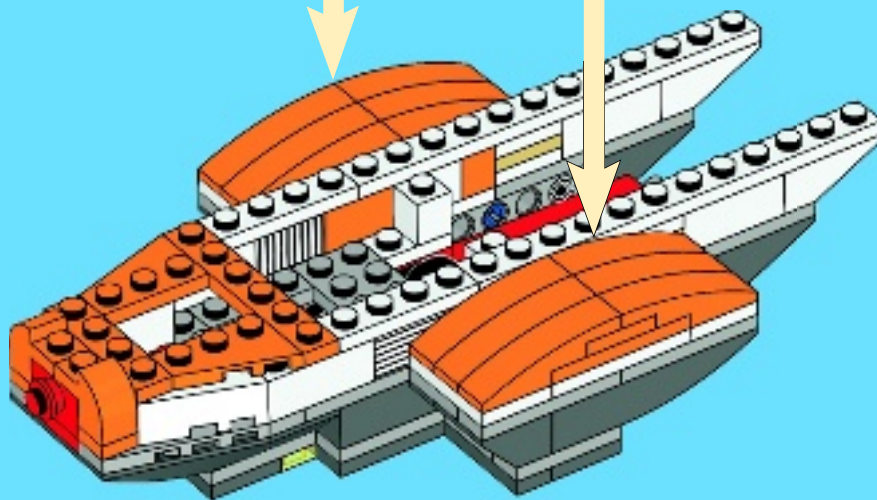

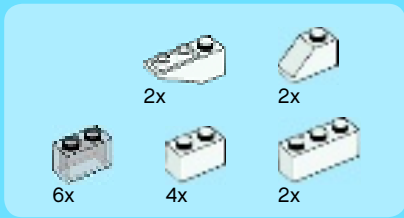

29

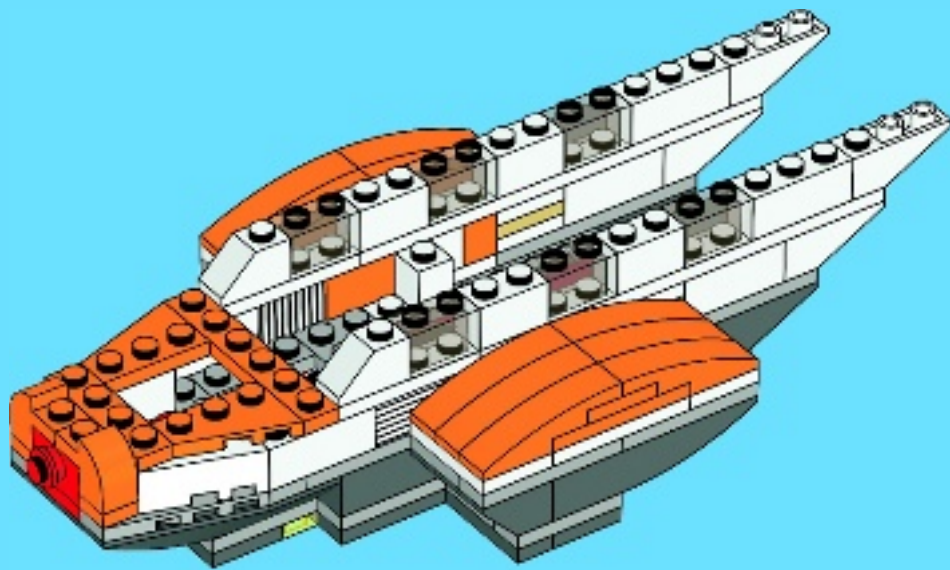

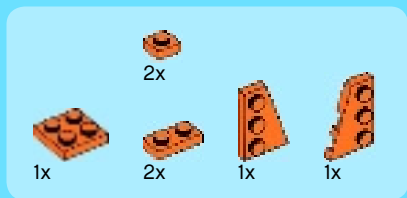

30

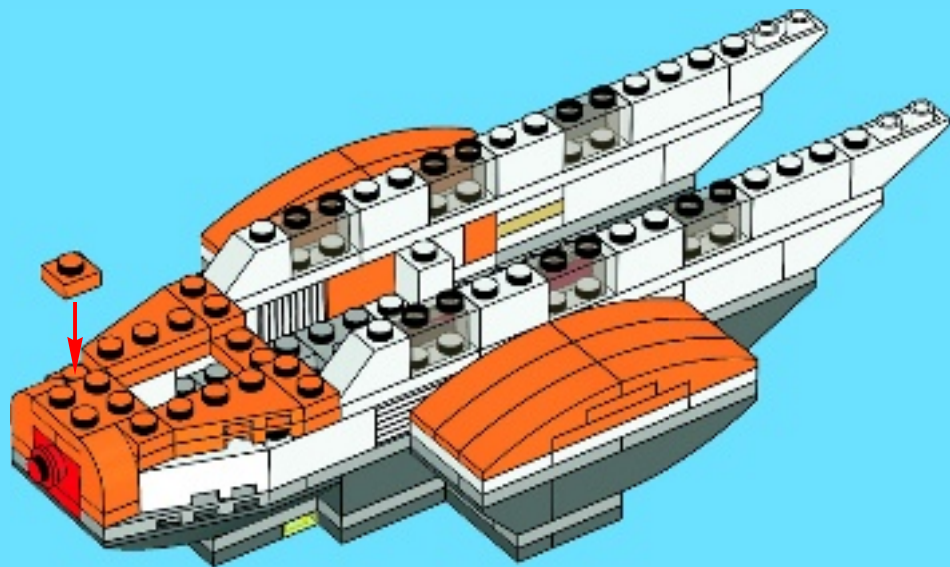



2x



2x



2x

31

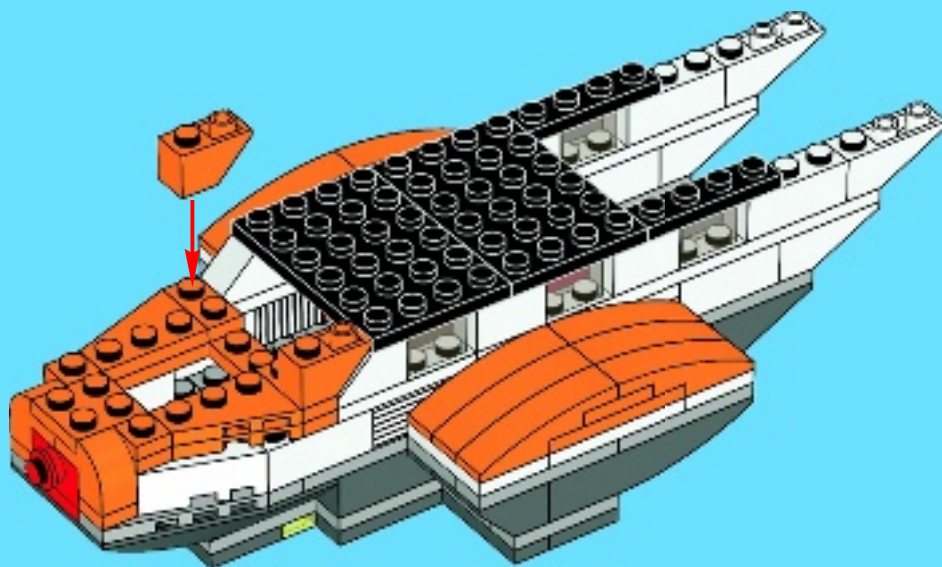



2x



2x



1x

32

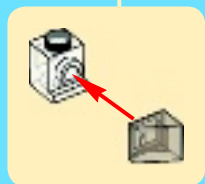
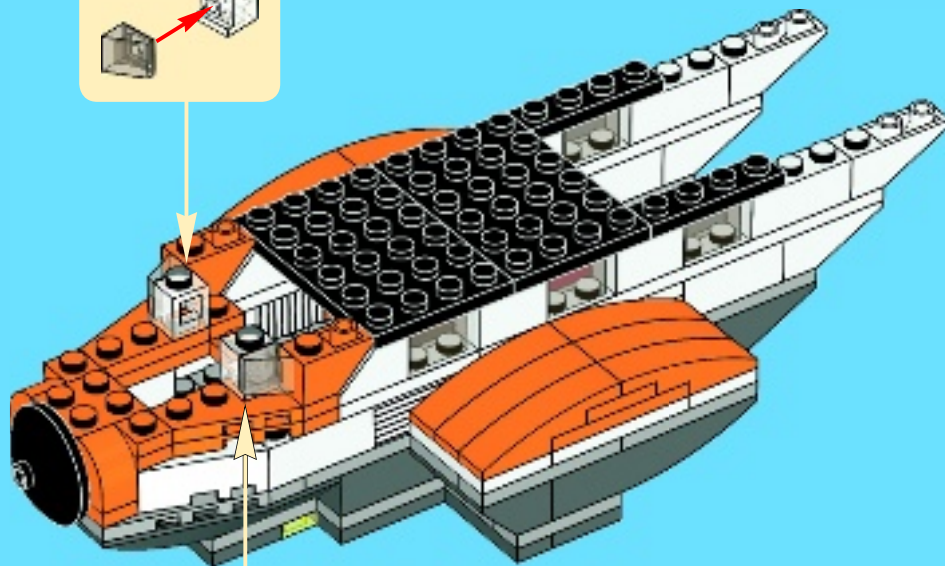
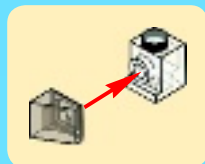

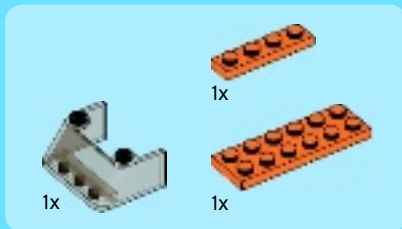

33

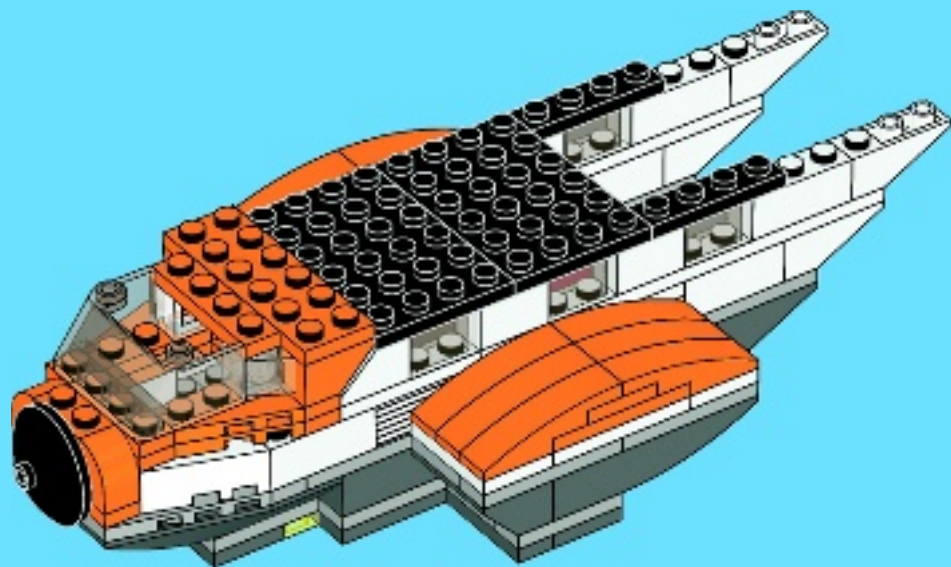



2x



2x



2x

34

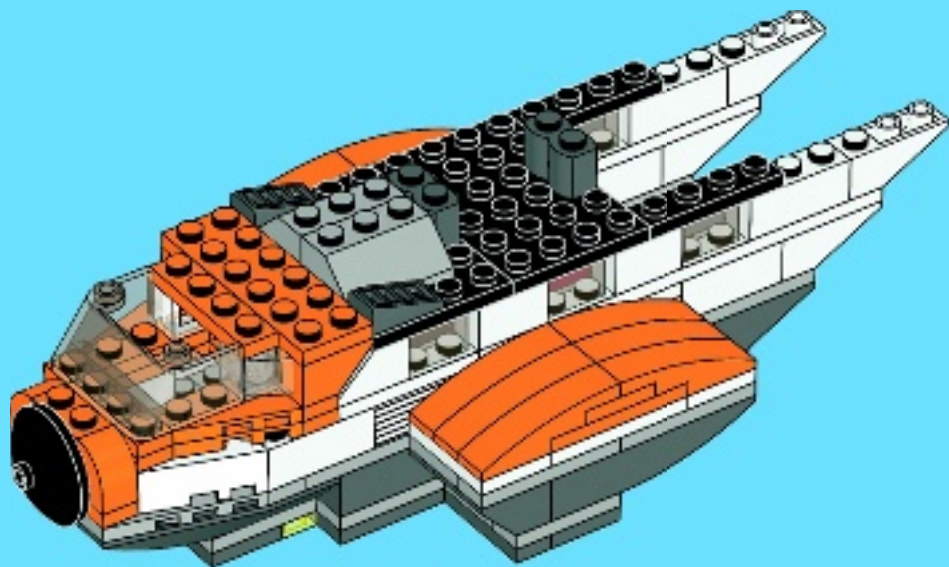



1x



1x

1

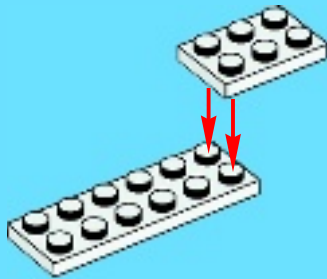

1x

2





1x

3



1x

4



1x



1x

5



1x

6

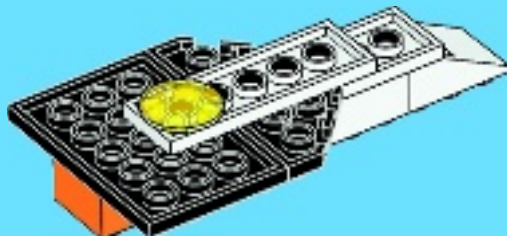

7



35

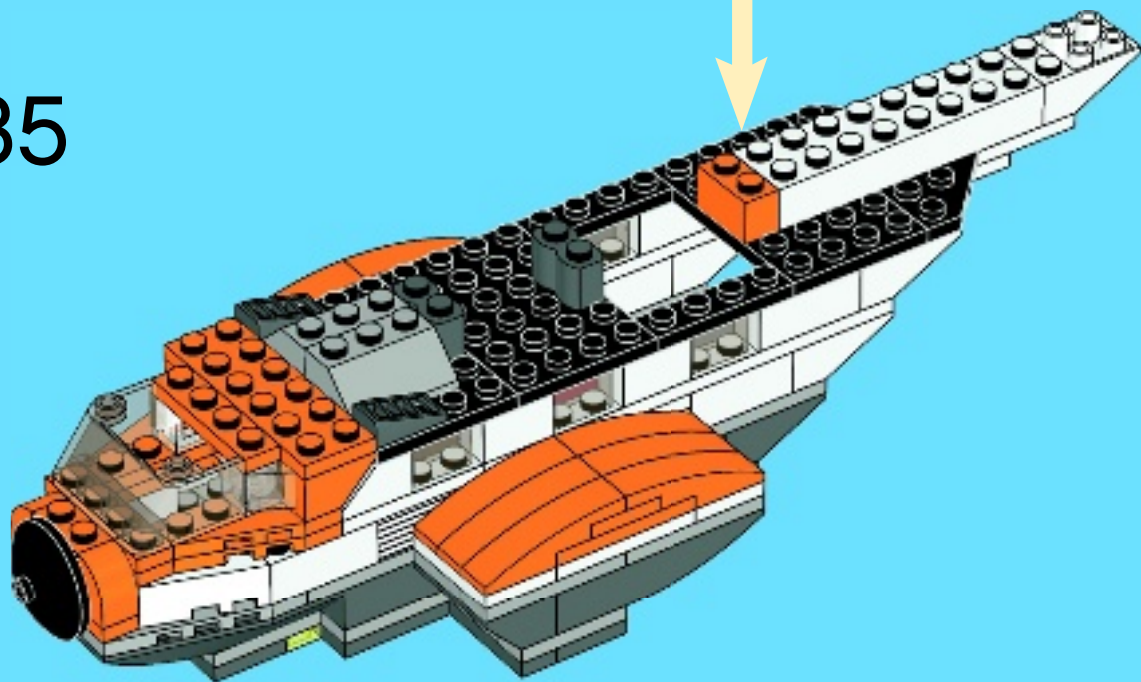

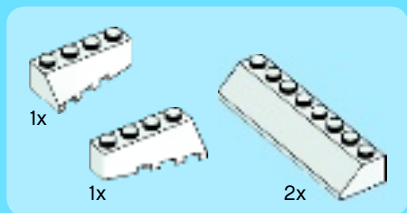

36

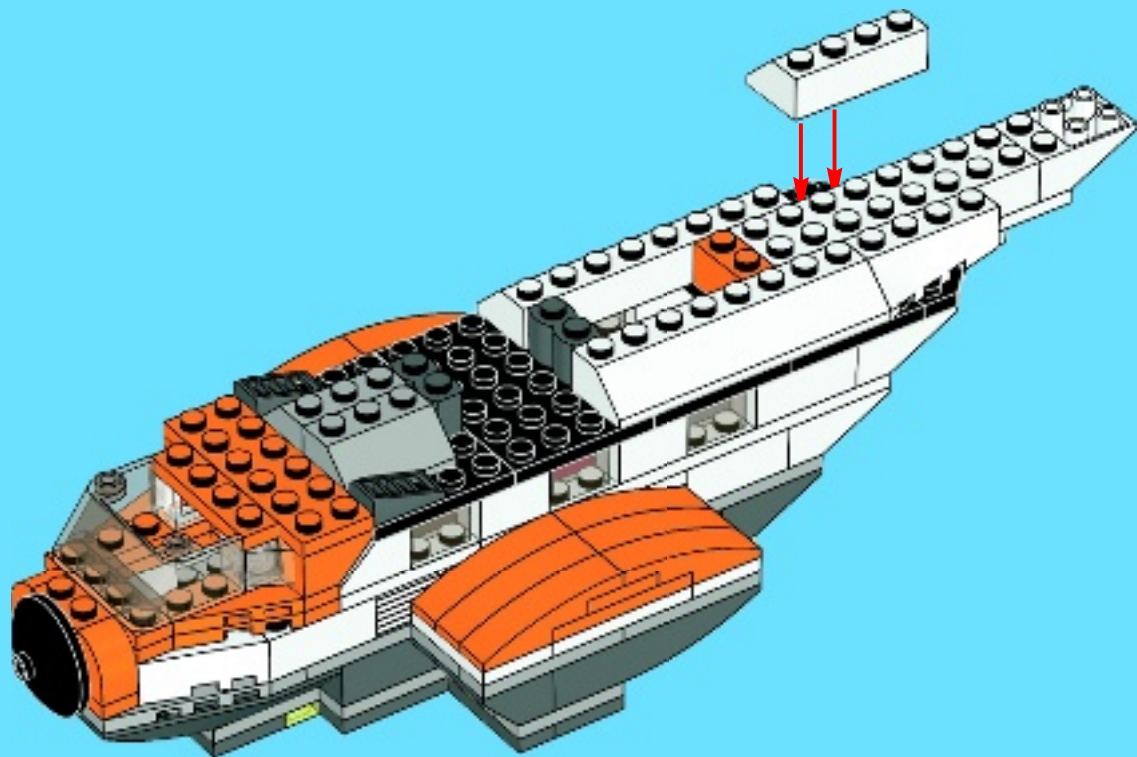

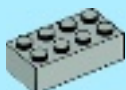

2x

37





2x



2x



1x



1x



2x

38





4x

39

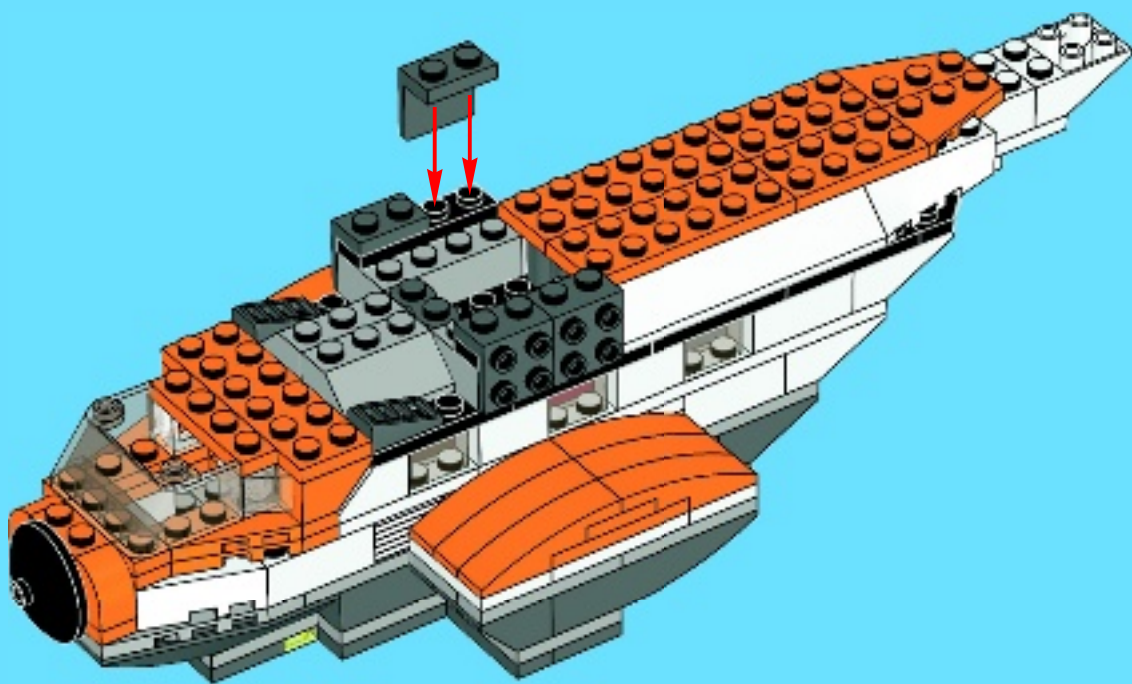

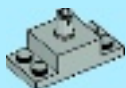

2x

40

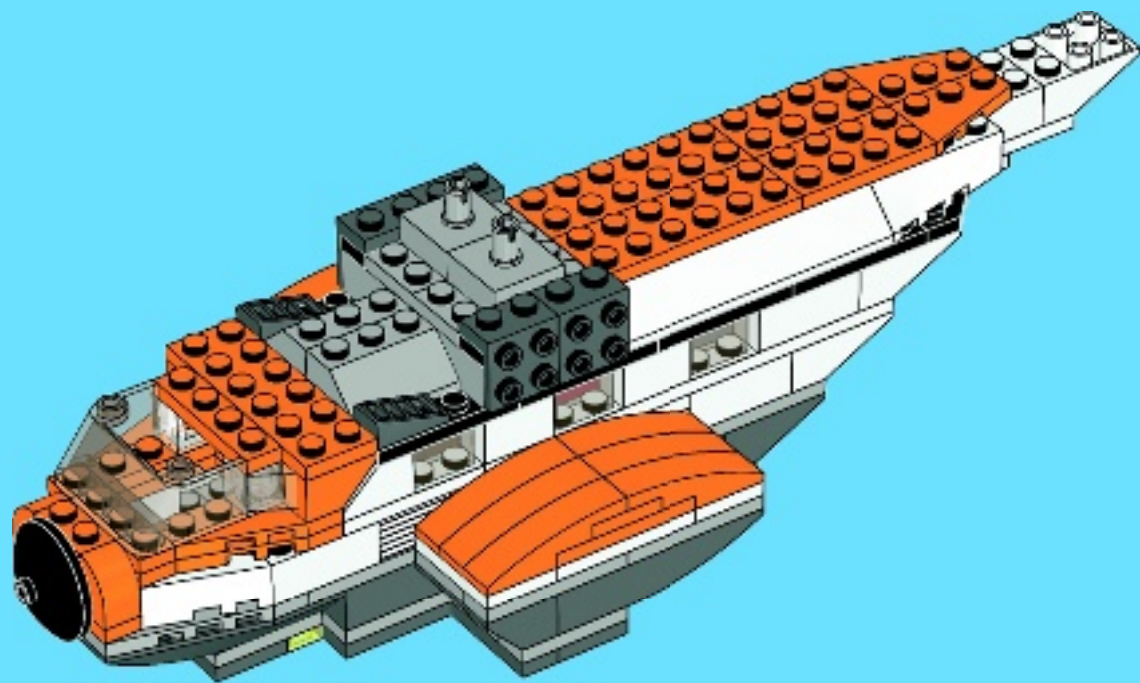



2x



1x

41

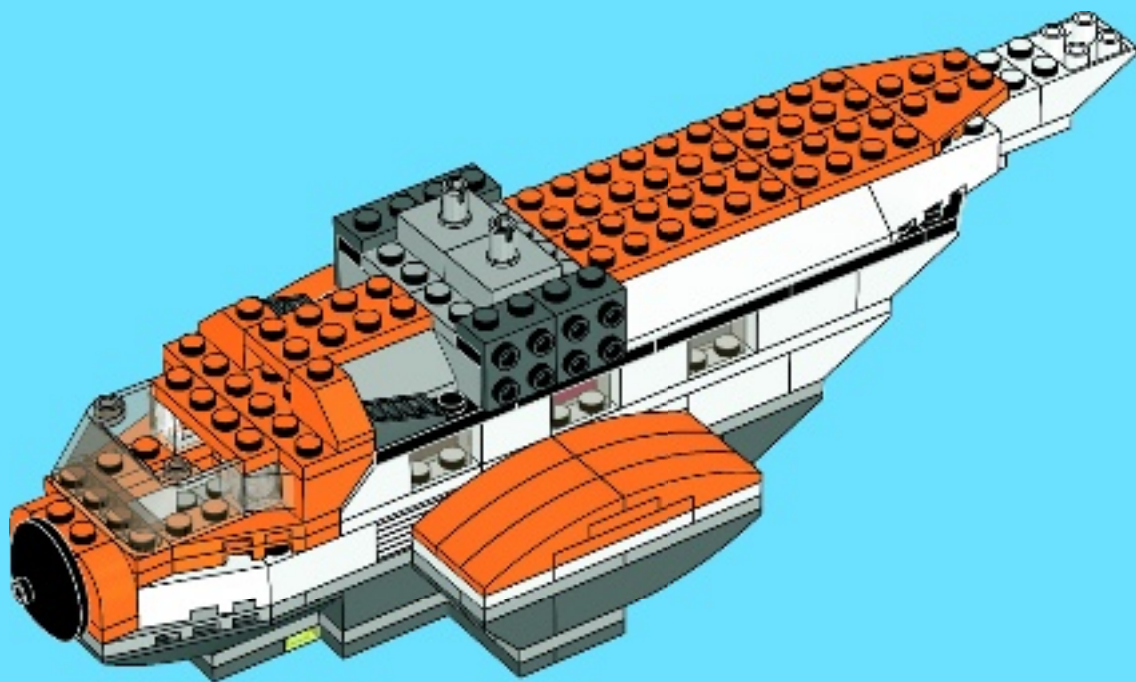



2x



2x



2x

42

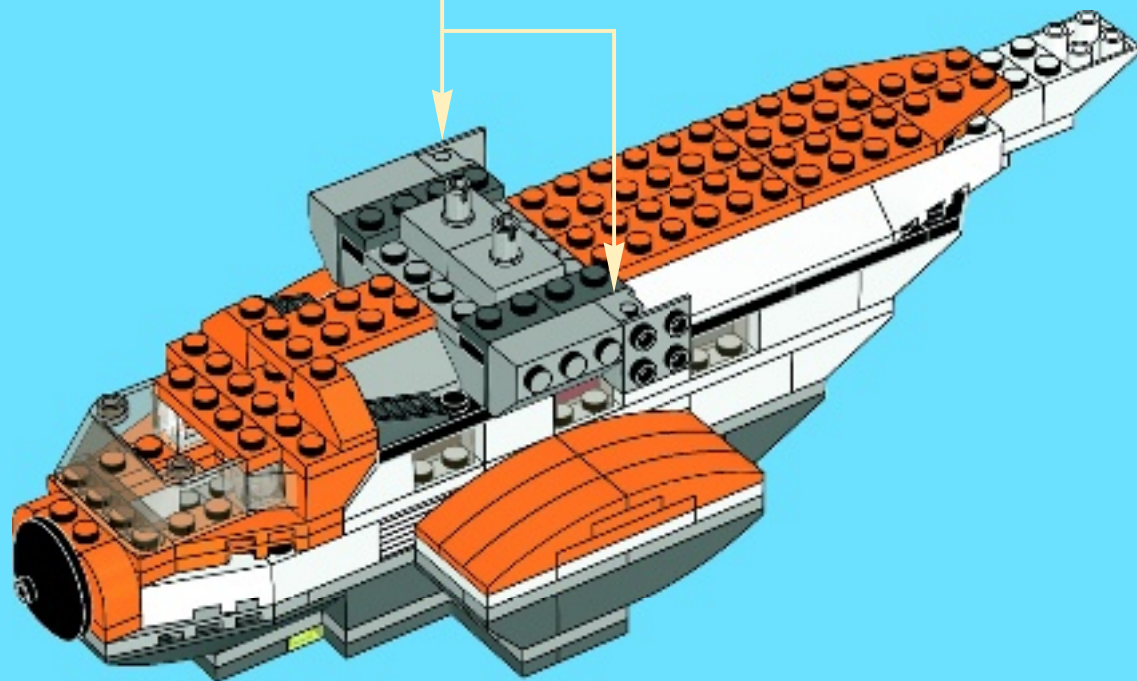
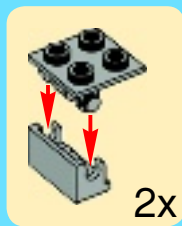



1x



1x

43

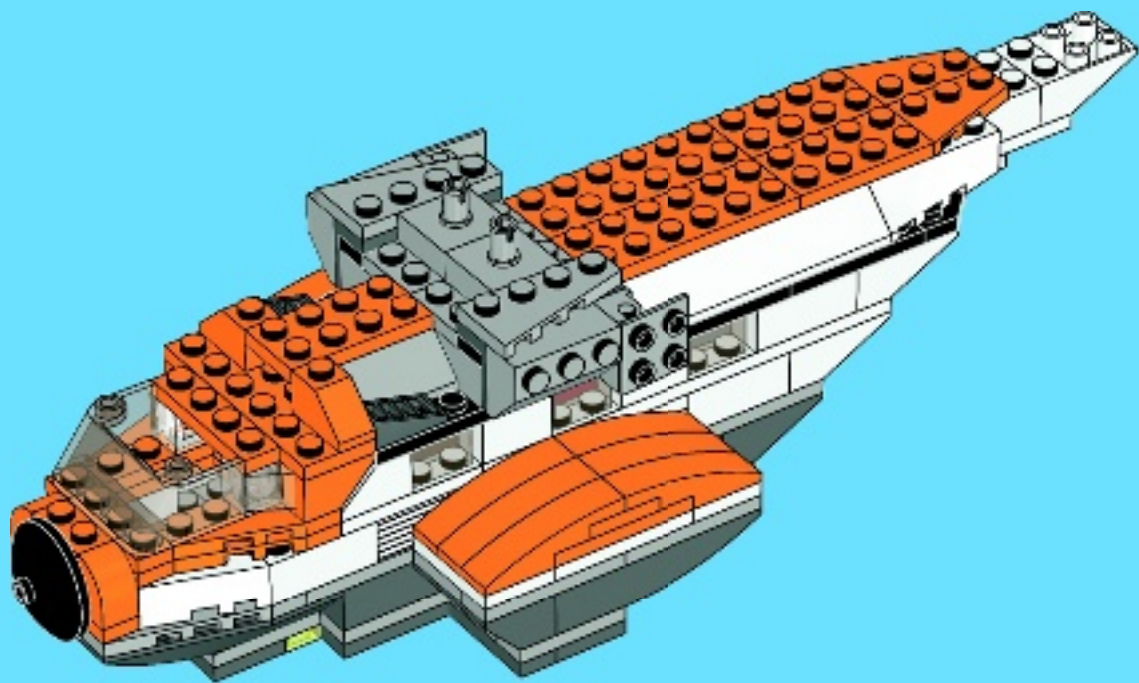



2x



2x

44

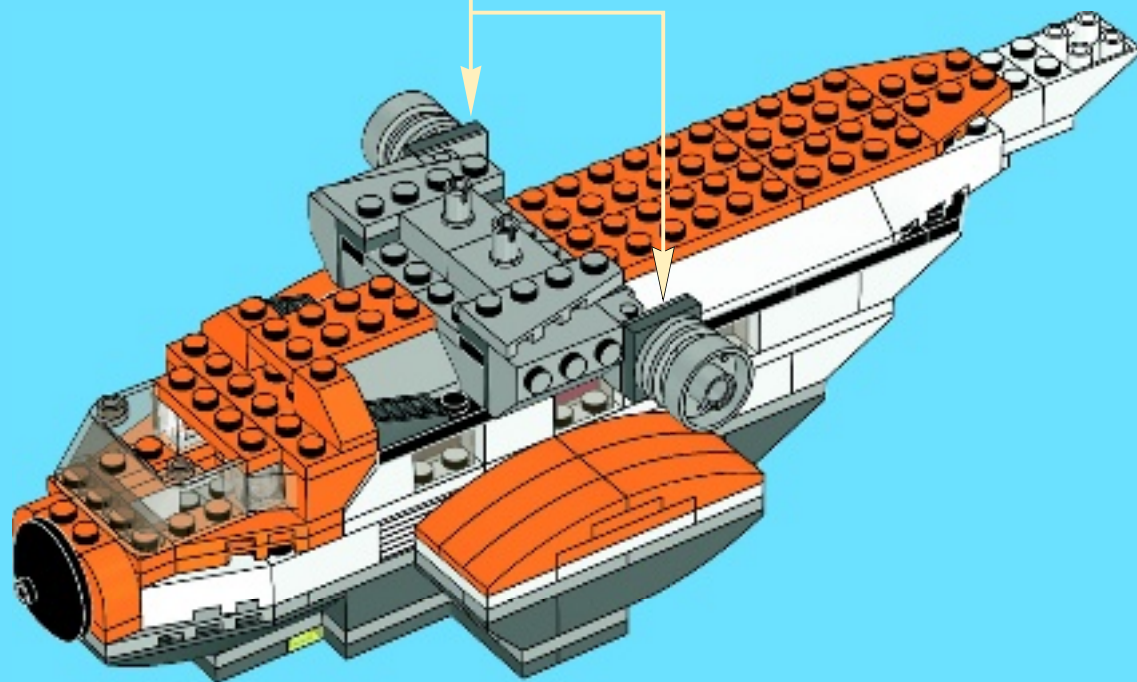
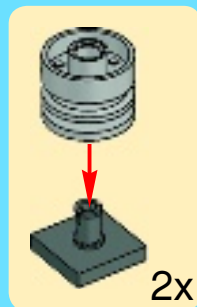

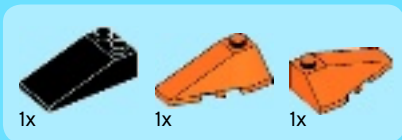

45

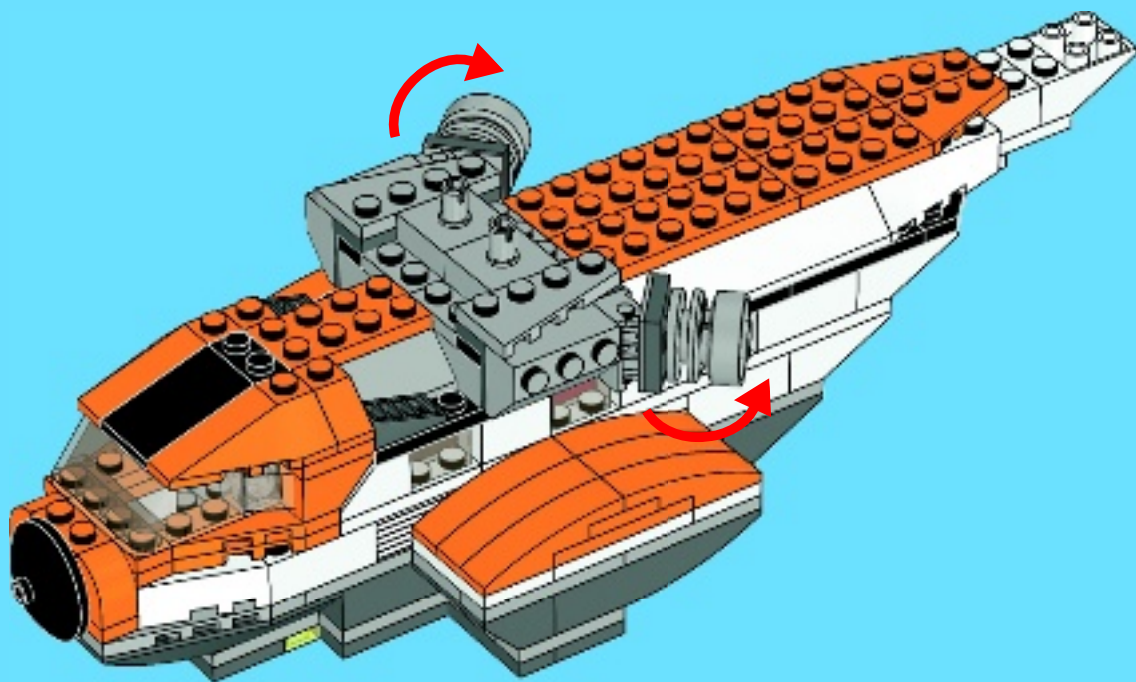



2x



2x



2x

46

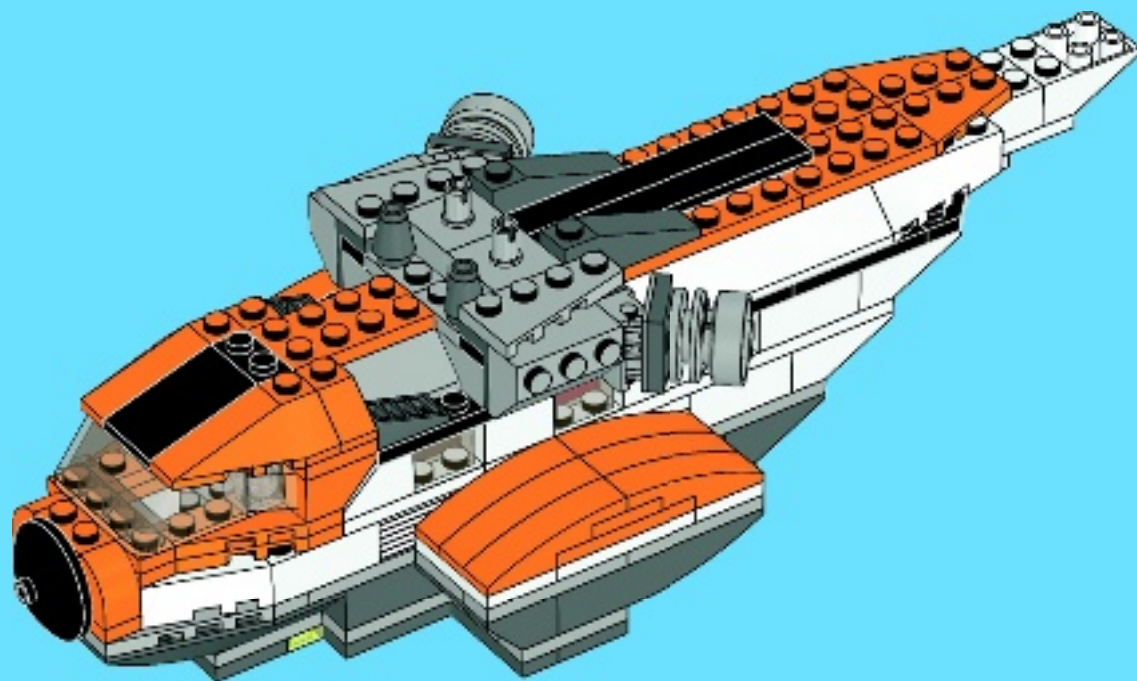



2x



2x



1x

47

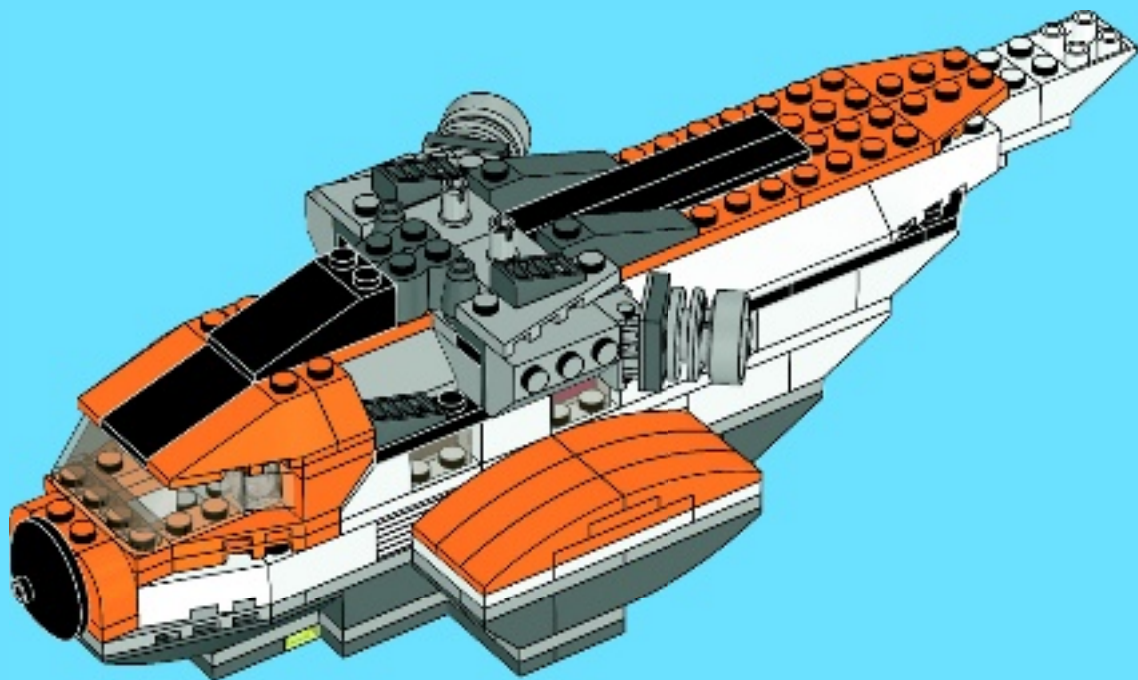



2x



2x

48

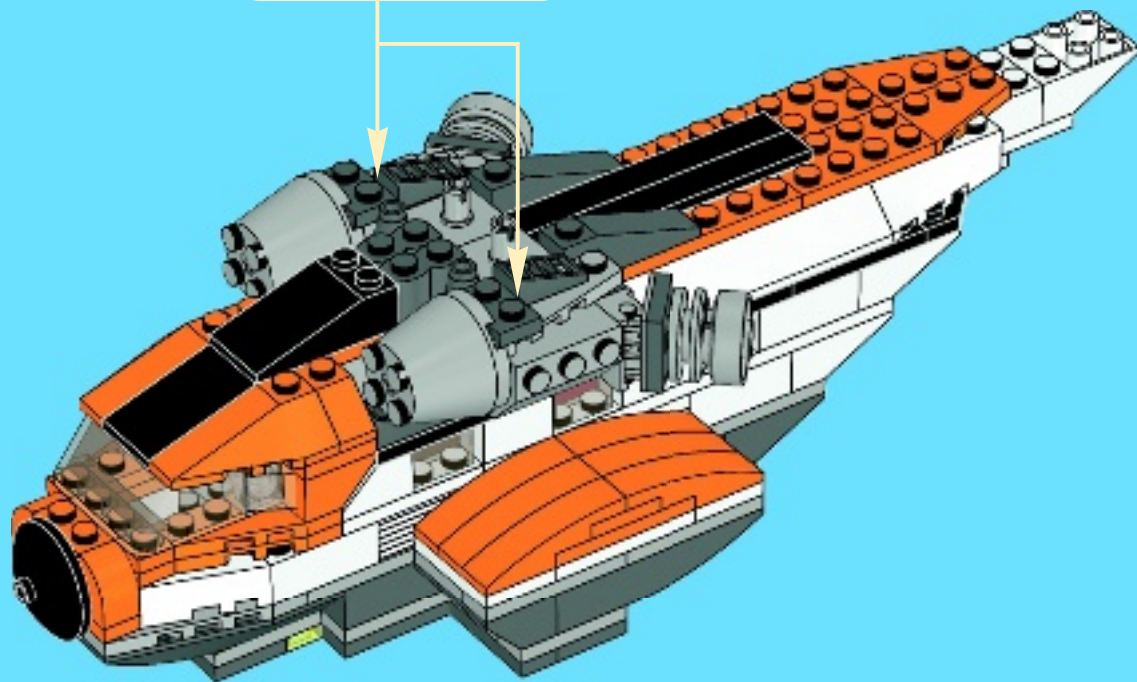
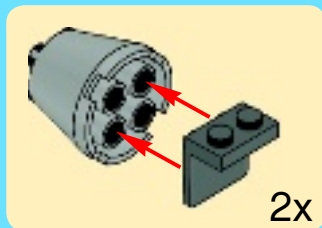

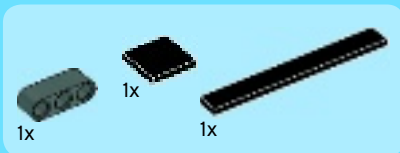

49

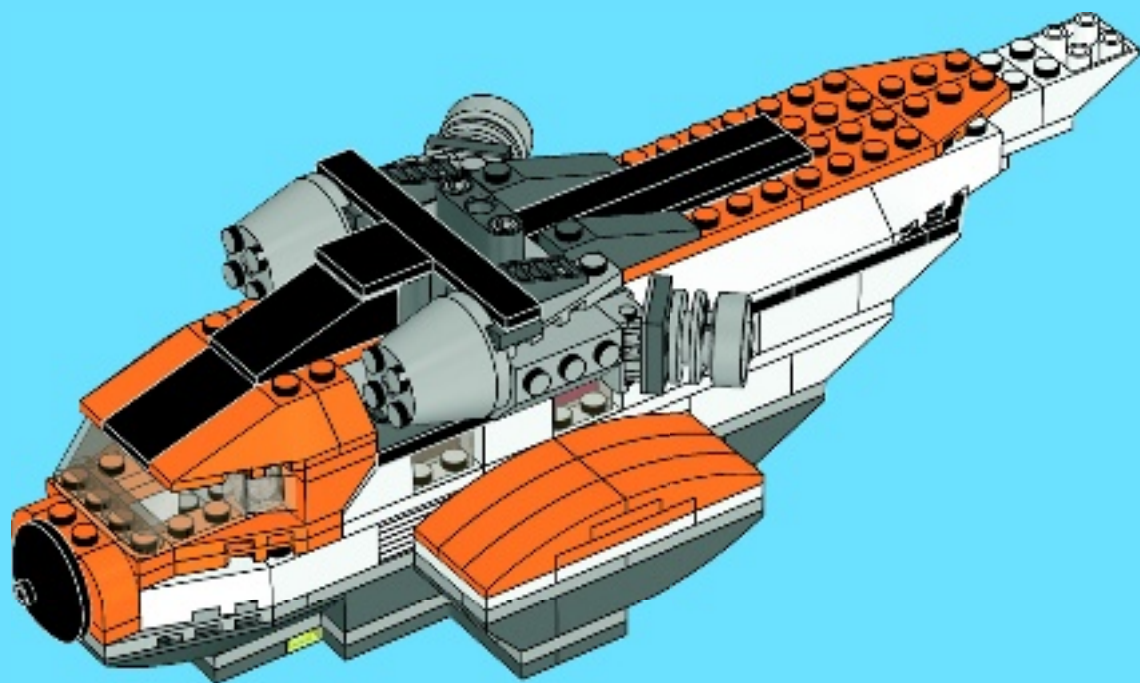



1x



1x

1

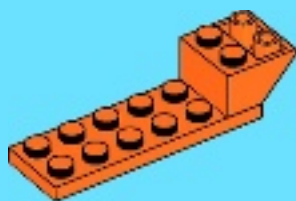

2x



1x

2



1x



1x

3



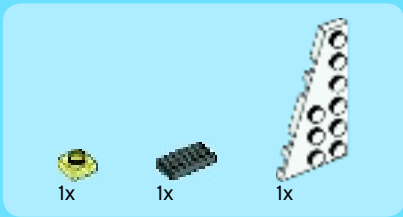

4

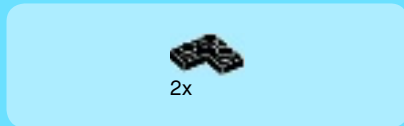
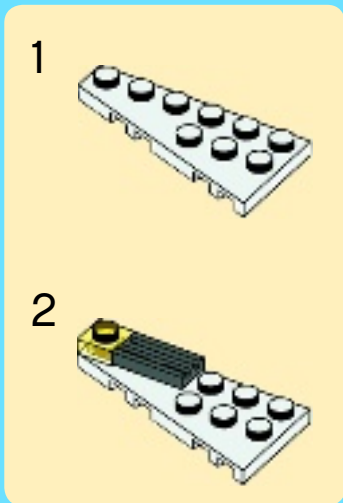

5





1x



1x



1x

6

1

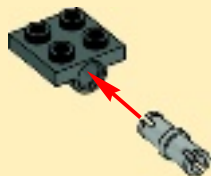

2

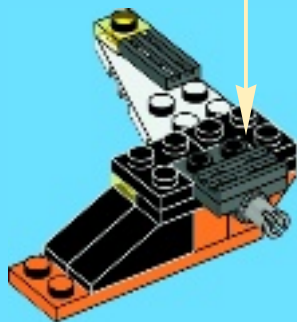

4x

7

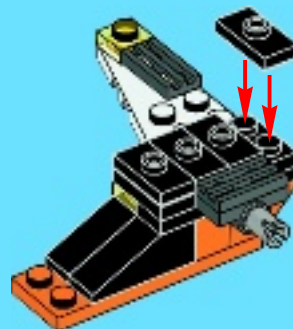



1x



1x

8



1x



1x



1x

9

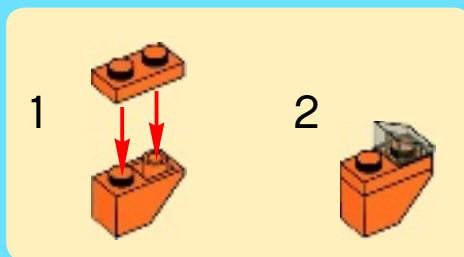

1

2

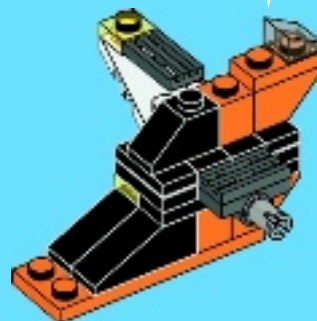



1x

10

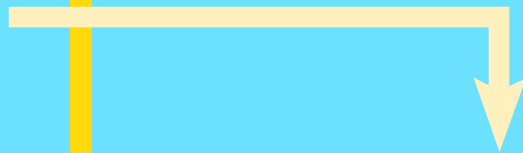

50

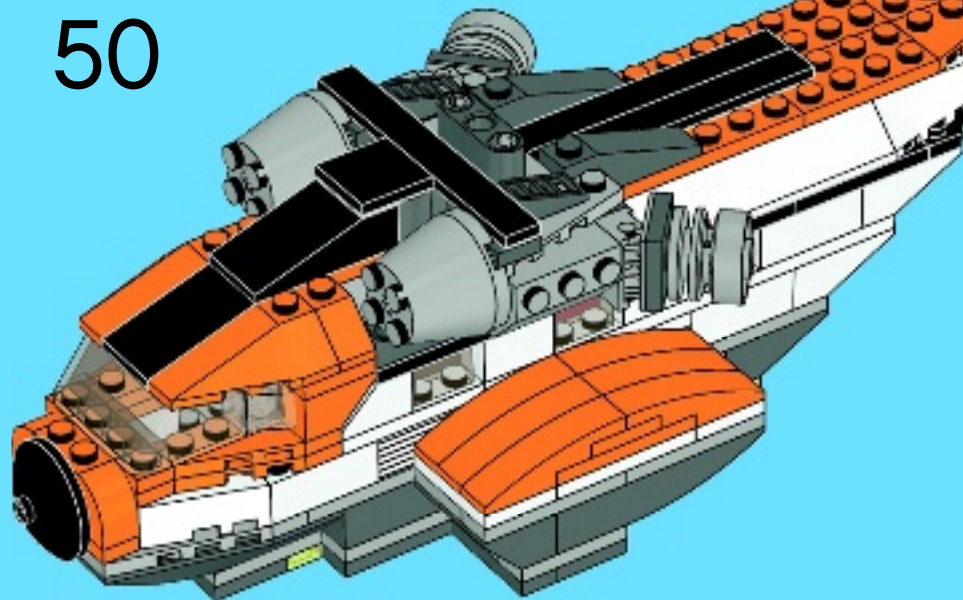



1x



1x



3x

51

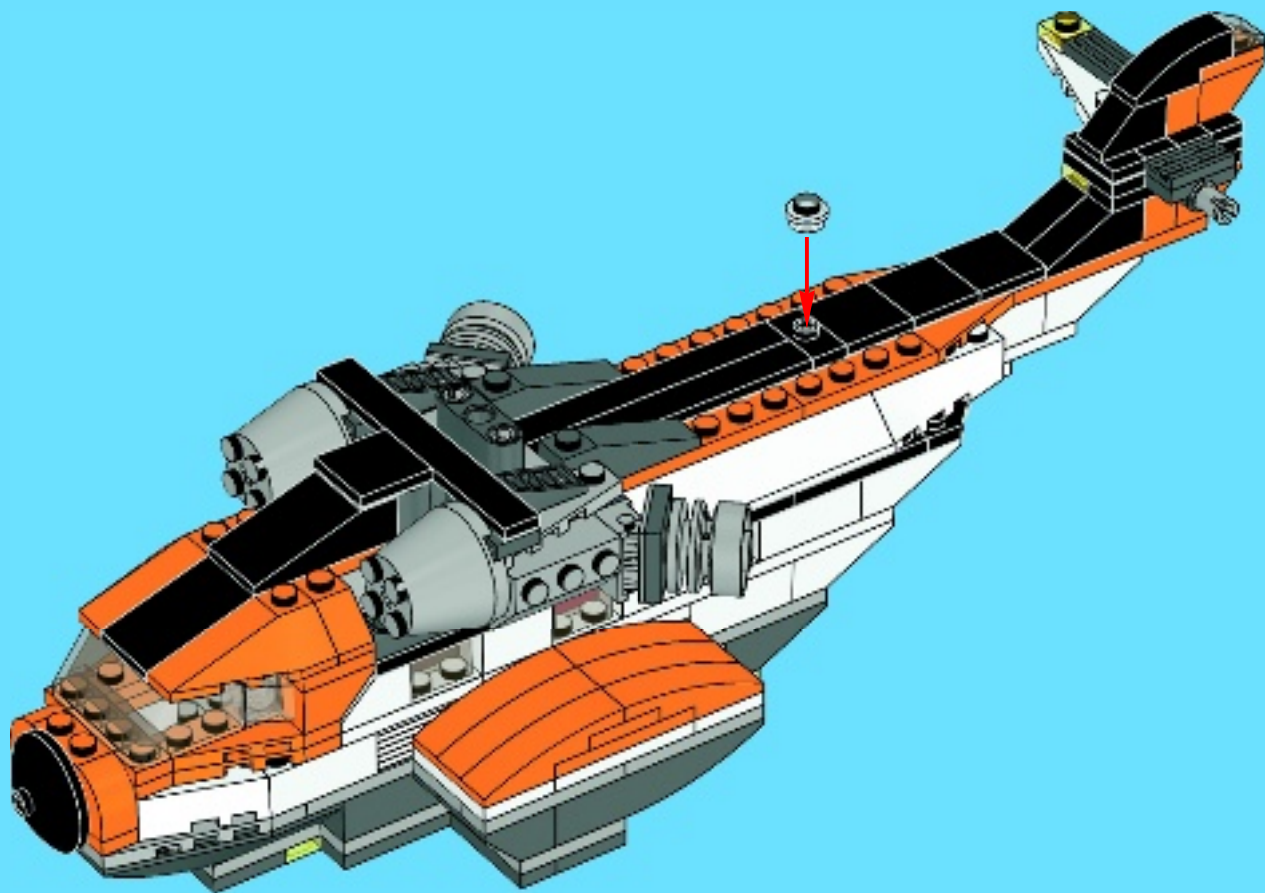



4x



4x



1x

52

1



2

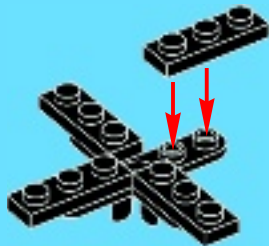

3

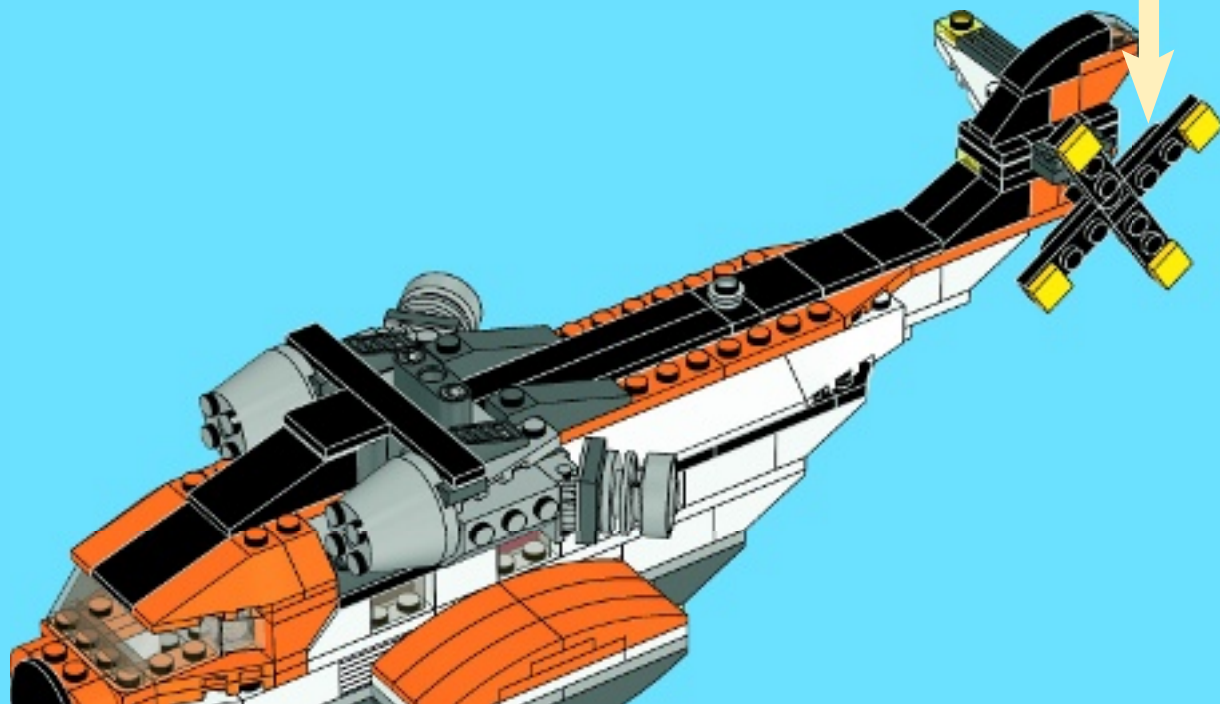
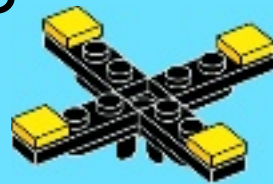



1x

53

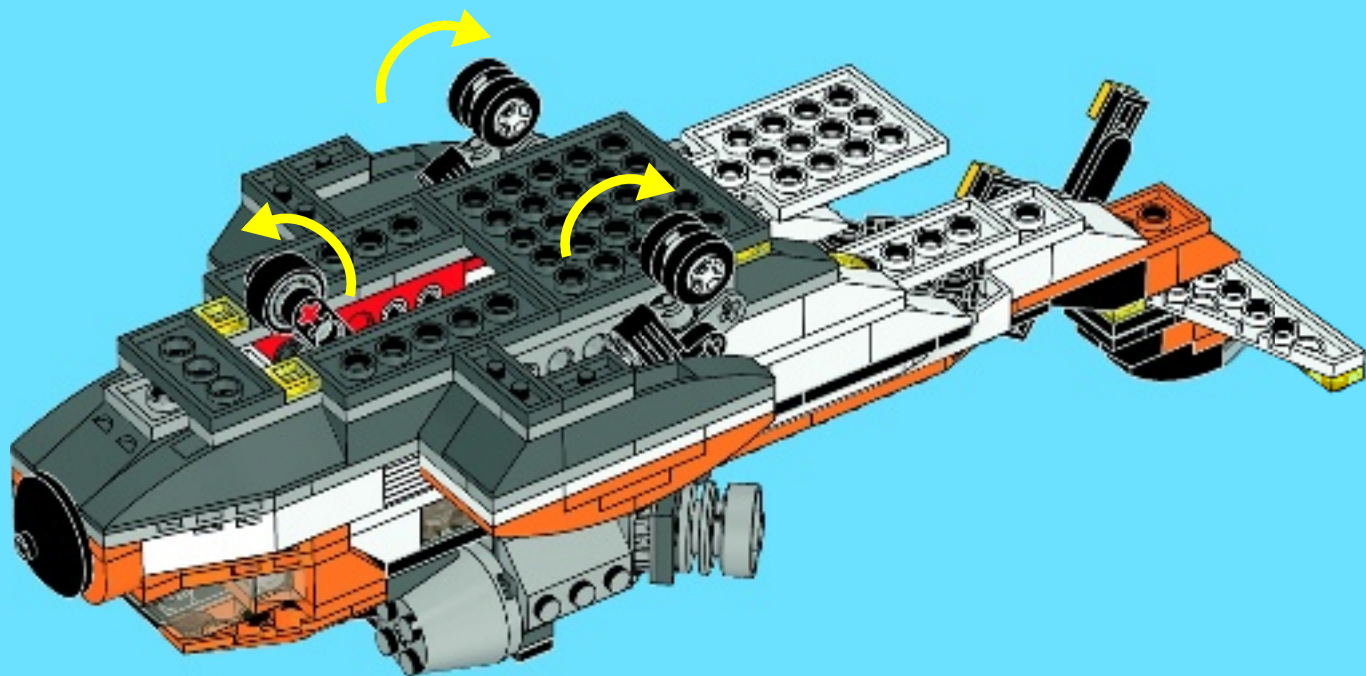

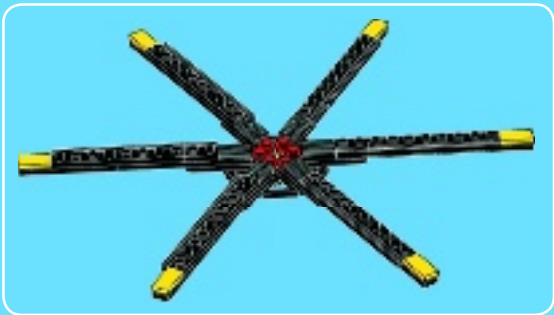

1x

1



6x

2

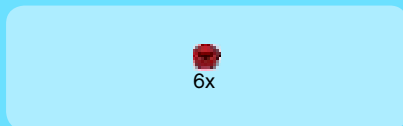

6x

3



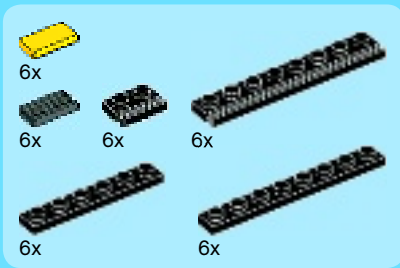

4

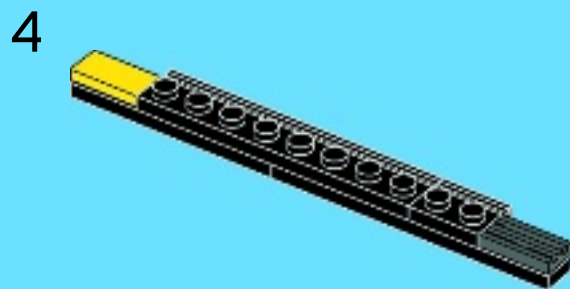
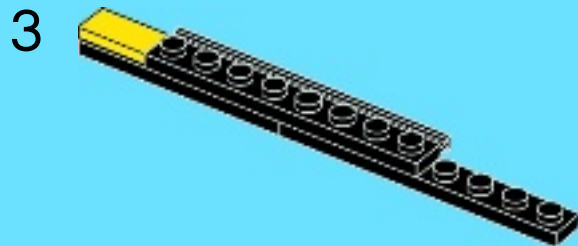
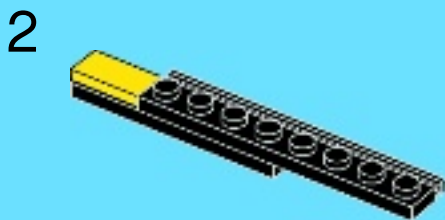
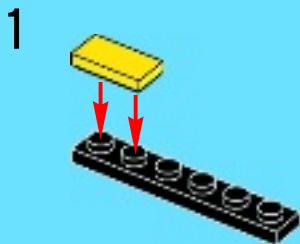

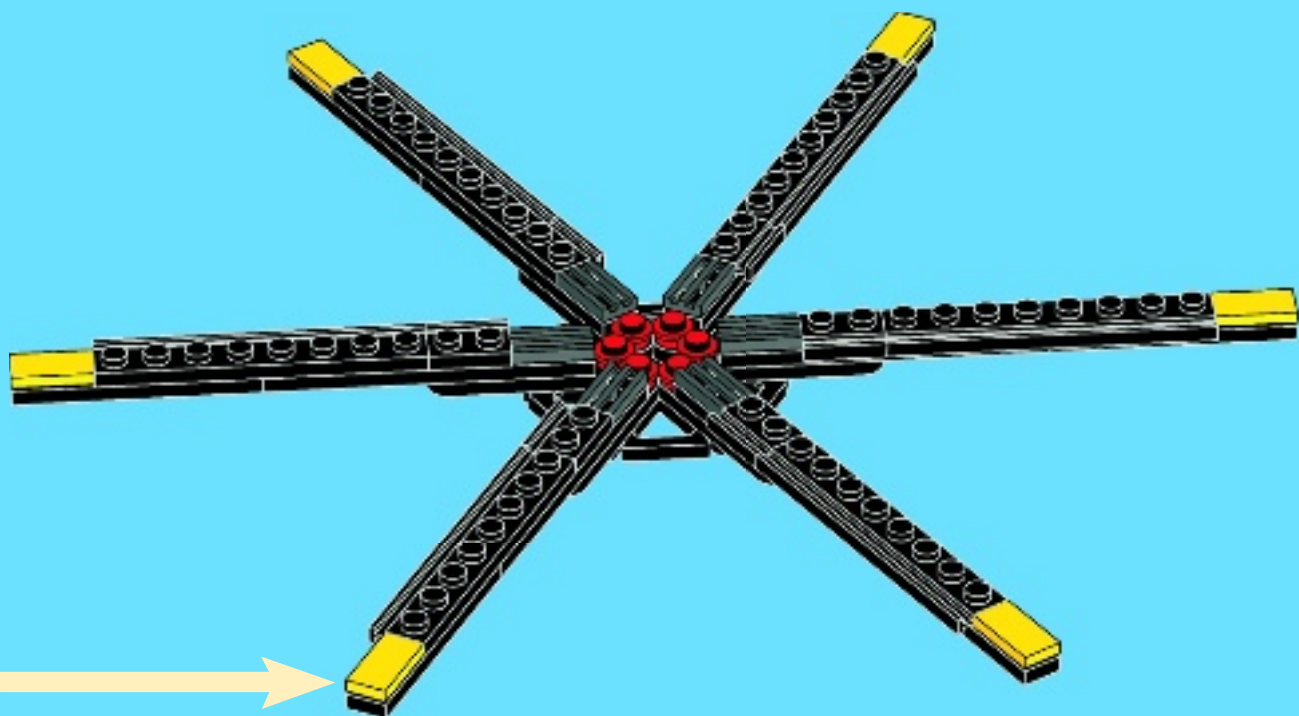

54

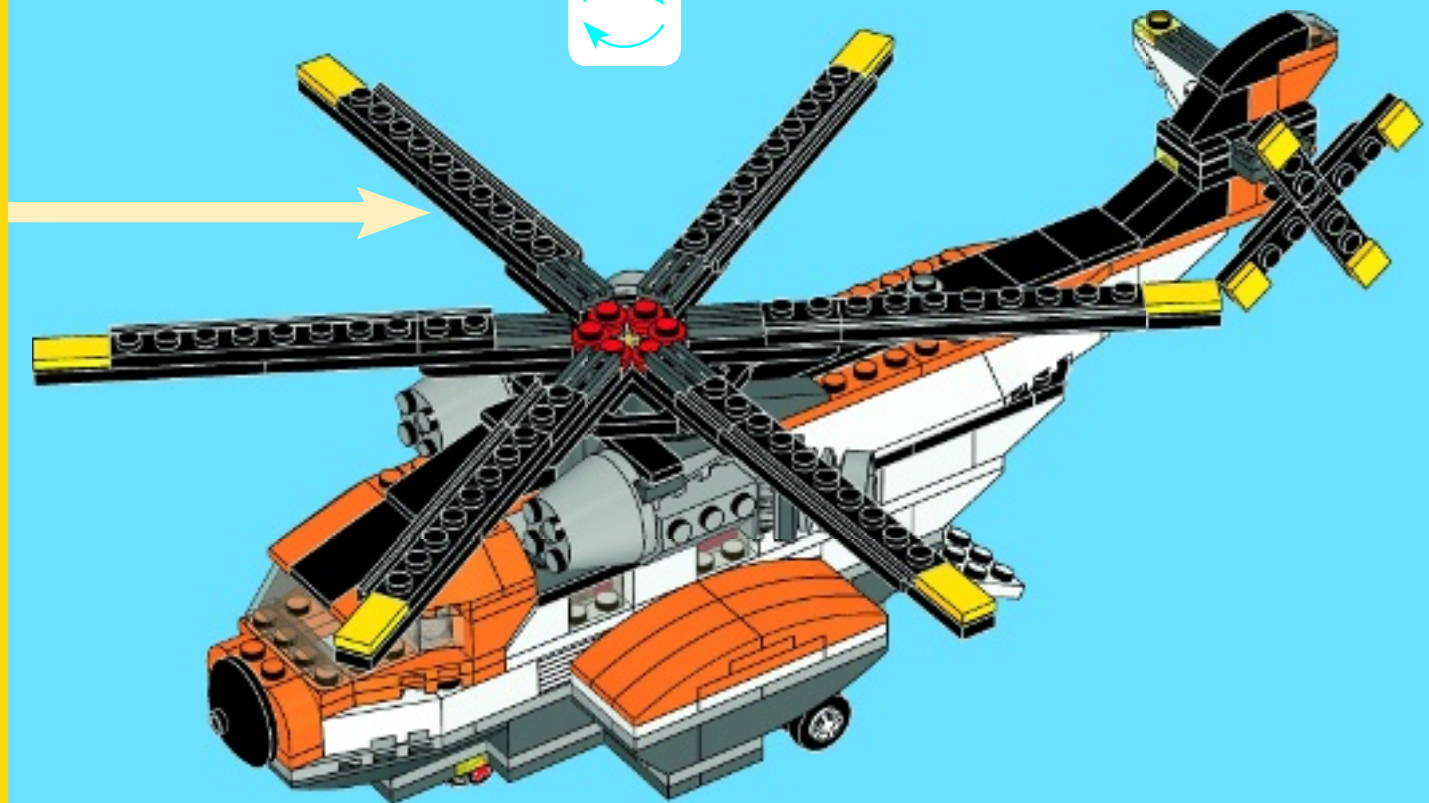



1x



1x

55

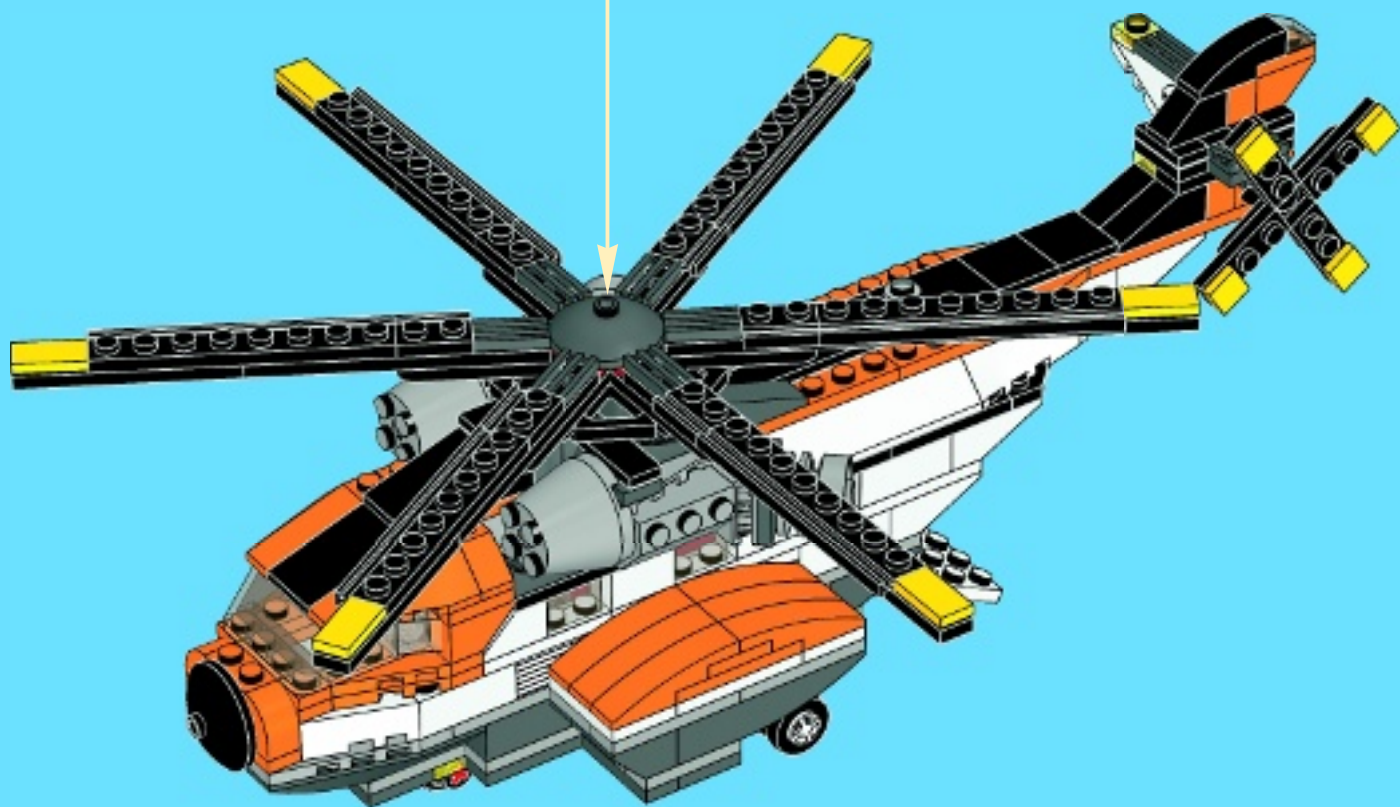
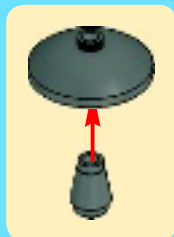

56





4x
300401



2x
235701



6x
362201



1x
300201



1x
300701



2x
287701



1x
4526928



1x
4527764



2x
4121932



4x
428701



1x
4500469



2x
4163984



2x
4514842



1x
4287708

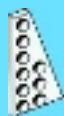

1x
4287707



8x
462401



1x
4179872



1x
4179873



4x
302301



4x
302201



3x
302101



4x
371001



2x
302001

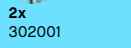

1x
379501



1x
4599044



1x
421966



2x
428626



2x
4185583



1x
4251161



2x
242026



4x
362326



5x
371026

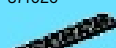

6x
366626

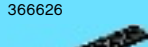

6x
346026

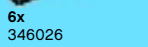

3x
303226



5x
379426



6x
4107761



4x
306826



6x
4114689



1x
4539442



3x
416226

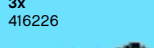

6x
4286009



1x
4180087



1x
241926



1x
4246901



4x
4578677



4x
4516843



1x
247926



2x
4142236



2x
4610371



2x
4184169



4x
4121715



2x
3005740



3x
3000844



6x
4278415



1x
4226179



6x
4244368



3x
4201201



1x
4124083



1x
4173805



3x
4121739



4x
4616279



4x
4121967



3x
4118829



2x
4585496



2x
4523603



12x
4523603



4x
4524929



4x
4177932



1x
4159007



2x
4125278



4x
4118782

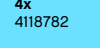

3x
4158355

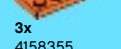

1x
4173332



1x
4121741



4x
4180512



3x
4180540



3x
4662210



3x
4662204

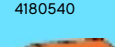

1x
4662204

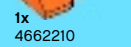

1x
4662204



1x
4662204



4x
4211773



2x
4211399



4x
4211429



3x
4211396



6x
4211445



5x
4211438



2x
4211452



1x
4211462



2x
4535738



1x
4211419



2x
4211732



2x
4211735



2x
4211385



2x
4211666



2x
4497653

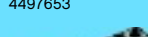

2x
4211442



2x
4299119



2x
4211504



2x
4519013



2x
4211469



2x
4211881



1x
4211629



2x
4211621



1x
4211758



1x
4211807



4x
307024



6x
306924



2x
4113917



2x
4666579



2x
370021

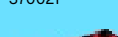

2x
389421



2x
242021



3x
302021



1x
306821



1x
4282742



2x
4113858



7x
614121



1x
4142865



1x
4143005



4x
4206482



3x
4529240



2x
4211096



2x
4211000



2x
4211068



1x
4211064



2x
4535930



2x
4210779



1x
4662198



1x
4662199



2x
4211063



2x
4211133



2x
4211002



2x
4211104



4x
4211095



9x
4210631



6x
4277928



2x
4211129



1x
4196768



2x
4227398



2x
4210633



1x
4210865



4x
4540386



1x
4210751



3x
4211050



1x
4211134



Customer Service

Kundenservice

Service Consommateurs

Servicio Al Consumidor

LEGO.com/service or dial



00800 5346 5555 :



1-800-422-5346 :





CREATOR

7347



creator.LEGO.com





CREATOR



creator.LEGO.com



CREATOR



creator.LEGO.com/game





CREATOR



creator.LEGO.com/videos



LEGO club
FREE! GRATIS! GRATUIT!



www.LEGOclub.com



LEGO Club Magazine



LEGO Club Email

VISIT THE WORLD'S
BIGGEST LEGO SHOP!

www.LEGOshop.com

00800 5346 5555

1-866-534-6258 • 1-877-518-5346

- * Freephone. Mobile charges may apply.
- * Numéro sans frais. Des frais peuvent s'appliquer avec les téléphones cellulaires.
- * Gebührenfrei. Kosten für Anrufe aus Mobilfunknetzen können abweichen.
- * Gratis telefonnummer vanaf vaste lijn.
- * Det er gratis nummer, når du ringer fra fasttelefon.
- * Det är gratis, när du ringer från en fast telefon.
- * Numéro sans frais. Des frais peuvent s'appliquer avec les téléphones portables.



8115

YES! I want to join the LEGO® Club FREE! **OUI!** Je veux m'abonner au LEGO® Club GRATUITEMENT !
Ja! Ich möchte Mitglied im kostenlosen LEGO® Club werden. **Ja!** Ik wil graag GRATIS lid worden van de LEGO® Club.
Ja! Jeg ønsker å melde meg inn i LEGO® Club gratis! **Ja!** Jag vill gå med i LEGO® Club GRATIS!

First name • Prénom
Vorname • Voornaam
Fornavn • Förnamn
Last name • Nom de famille
Name • Achternaam
Etternavn • Efternamn

Date of Birth • Date de naissance
Geburtsdag • Geboortedatum
Fødselsdato • Födelsedatum

Boy • Garçon
Junge • Jongen
Gutt • Pojk

Girl • Fille
Mädchen • Meisje
Jente • Flicka

Street • Adresse
Straße, Hausnr.
Straat, huisnr. • Adress

City • Ville
Ort • Woonplaats
Poststed • Postort

State
Prov.
Country

Zip/Postcode
Code Postal • PLZ
Postcode
Postnummer

Country
Pays
Land

Email • Courriel
E-Mail • E-post

- Fill in your email address and we will send you a membership confirmation and monthly email newsletters. If you do not wish to receive the newsletters please tick here. Remplis ton adresse e-mail et nous t'enverrons une confirmation d'adhésion ainsi que le bulletin e-mail mensuel. Si tu ne désires pas recevoir le bulletin, coche cette case. Vul je e-mailadres in en we sturen je een bevestiging van je lidmaatschap en maandelijks e-mail nieuwsbrieven. Als je geen e-mail wilt ontvangen, kruis dan dit vakje aan.
- Ich möchte per E-Mail den monatlichen LEGO Club Newsletter erhalten. Ønsker du at vi skal sende en liten lisen til barnet ditt for å bekrefte medlemskapet, ber vi deg kryssse av i feltet, samt oppgi e-postadressen som hilsenen skal sendes til. Om du vill att vi ska skicka en bekräftelse på ditt barns medlemskap, ber vi dig sätta ett kryss i rutan och skriva den e-post adress som bekräftelsen ska skickas till.
- If you do not wish to receive additional mailings from the LEGO Club please tick here. Si tu ne désires pas recevoir de courrier supplémentaire du Club LEGO, coche cette case. Als je geen verdere post van de LEGO Club wilt ontvangen, kruis dan dit vakje aan.
- Dersom du ønsker å motta annen informasjon fra LEGO Gruppen, setter du et kryss her.

Mail to: / Poster à:	LEGO® Club P.O. Box 1157 Enfield, CT USA 06083-1157	Per Post an:	LEGO® Club Postfach 14 15 D-36243 Niederaula	Send til:	LEGO® Club Norge Postboks 58 1314 Vøyenenga
Mail to:	LEGO® Club 33 Bath Road Slough SL1 3UF United Kingdom	Stuur op naar:	LEGO® Club Postbus 40250 3504 AB Utrecht	Skickas till:	LEGO® Club Sverige Ubox 841 202 29 Malmö
Poster à:		Post à:	LEGO® Club 21 rue de la banque 75 002 PARIS FRANCE		

The English language version of the magazine can only be mailed to addresses in the US, Canada, the UK, and Republic of Ireland. Club membership is valid for two years and includes free copies of the LEGO Club Magazine and e-mail newsletters. In the US and Canada please allow up to 6 weeks for delivery of your first magazine. In the UK and Republic of Ireland please allow six to 14 weeks for delivery of your first magazine. By signing this form you consent the LEGO Club to use your child's data for LEGO mailings. The data will only be used for LEGO mailings and will not be sold, rented or otherwise disclosed to any company outside the LEGO Company except for disclosure to companies acting as our agents to help us provide services requested by the child. This coupon is valid for one free membership per person, group or organization. No photocopies are accepted. La version française du magazine peut être postée uniquement au Canada. L'abonnement est valide pour 2 ans et inclut des exemplaires gratuits du Magazine LEGO. Aux E-U et au Canada, allouer 6 semaines pour la livraison initiale. En remplissant ce formulaire, vous consentez à ce que LEGO utilise les informations de votre enfant pour des envois postaux de LEGO. L'information sera utilisée uniquement pour des envois postaux par LEGO et ne sera en aucun cas, vendue, louée, échangée ou divulguée à d'autres compagnies autres que la compagnie LEGO. L'exception des compagnies affiliées qui nous procurent des services auxquels l'enfant en a fait la demande. Formulaire photocopies acceptées. Mit der folgenden Unterschrift erkläre ich, für mein Kind den Beitritt als Mitglied zum kostenlosen LEGO Club, der von der LEGO GmbH, D-85627 Grasbrunn, betrieben wird. Die Mitgliedschaft beinhaltet die Zusendung des LEGO Club Magazines und kann beiderseits getriggert beendet werden. Mit der Mitgliedschaft im LEGO Club sind keinerlei Verpflichtungen verbunden. Das deutschsprachige LEGO Club Magazin wird nur an Adressen in Deutschland, Österreich und der Schweiz versendet. Eine Anmeldebestätigung kann nur per E-Mail geschickt werden. Das Magazin erscheint fünfmal jährlich. Jedes Heft die Zustellung des ersten Heftes bis zu drei Monate dauern. Die Mitgliedschaft ist beidseitig jederzeit kündbar, ohne dass Ihnen Kosten entstehen. Sie können der werblichen Nutzung Ihrer Daten jederzeit widersprechen, Kündigung und Widerspruch können Sie telefonisch erklären (00800 / 5346 5555, Anruf gebührenfrei, Kosten für Anrufe aus dem Mobilfunknetz können abweichen) oder an die LEGO GmbH senden. Het Nederlandse LEGO Club Magazine kan alleen worden gestuurd naar adressen in Nederland. Het lidmaatschap is 2 jaar geldig en geeft recht op toezending van het gratis LEGO Club Magazine en LEGO Club e-mails. Het eerste magazine zal binnen 12 tot 14 weken toegestuurd worden. Het lidmaatschap kan op ieder moment opgezegd worden en kan na 2 jaar gratis worden verlengd, tenzij LEGO met deze activiteit stopt. Uw gegevens worden uitsluitend gebruikt voor mailings van LEGO en zullen niet worden verkocht, verhuurd of op welke wijze dan ook verstrekt aan derden buiten de LEGO Groep, uitgezonderd de organisaties die namens ons optreden om de informatie te sturen waarvoor toestemming is verleend. Den norske utgaven av magasinet sendes kun til adresser i Norge. Medlemskap i klubben gjelder i 2 år og inkluderer gratisutgaver av LEGO Club Magazine. Påregnet minimum opp til seks uker leveringstid for første magasin. Det å underrette dette skjemaet, gir du ditt samtykke til at LEGO Club kan bruke opplysningene om barnet ditt i LEGO forsendelser. Dataene vil utelukkende bli brukt i LEGO forsendelser og vil ikke bli solgt, utleid eller på annen måte gjøres tilgjengelig for selskaper utenfor LEGO gruppen, unntatt selskaper som er våre agenter og som hjelper oss å tilby tjenestene barnet etterseer. Dette skjemaet gjelder for ett gratis medlemskap per person, gruppe eller organisasjon. Den svenska versionen av tidningen kan endast skickas till adresser i Sverige. Club-medlemskapet är giltigt i 2 år och innefattar gratis exemplar av LEGO Club Magazine. Villigen rikna med minimum 6 veckor för leverans av din första tidning. Genom att skicka in det här formuläret godkänner du att LEGO Club använder barnets uppgifter för LEGO utskick. Uppgifterna kommer bara att användas för LEGO utskick och kommer inte att säljas, hyras ut eller vidarebefordras till något företag som inte tillhör LEGO Gruppen, med undantag av företag som agerar som våra ombud för att tillhandahålla tjänster som barnet har begärt. Den här kupongen gäller för ett gratis medlemskap per person, grupp eller organisation. En complément ce bulletin d'adhésion, vous acceptez que LEGO Club utilise les données relatives à votre enfant pour l'envoi de courriers concernant LEGO. Ces données seront uniquement utilisées pour l'envoi d'information concernant LEGO et ne seront ni vendues, ni louées, ni utilisées par d'autres sociétés que le groupe LEGO. À l'exception des sociétés agissant pour le compte de LEGO en tant que sous-traitant de services divers. L'abonnement au LEGO Club est valable pour une période de 2 ans. Il inclut LEGO par courrier du magazine LEGO Club et par email des newsletters. Un délai de 6 à 14 semaines est à prévoir pour la réception de votre premier magazine. Ce bulletin d'adhésion gratuit est valable pour l'inscription d'une seule personne. Les photocopies sont acceptées. ATTENTION! Le bulletin d'adhésion doit être rempli et signé par un parent ou un tuteur.

Parent's signature • Signature d'un parent ou d'un tuteur •
Unterschrift Erziehungsberechtigter • Handtekening ouders •
Föreläres/foresattes underskrift • Förälders förmyndares underskrift

Date
Datum
Date



WIN!

Go to www.LEGOsurvey.com/product to fill out a survey for a chance to win a cool LEGO® Product. No purchase necessary. Open to all residents where not prohibited.



LEGO.com

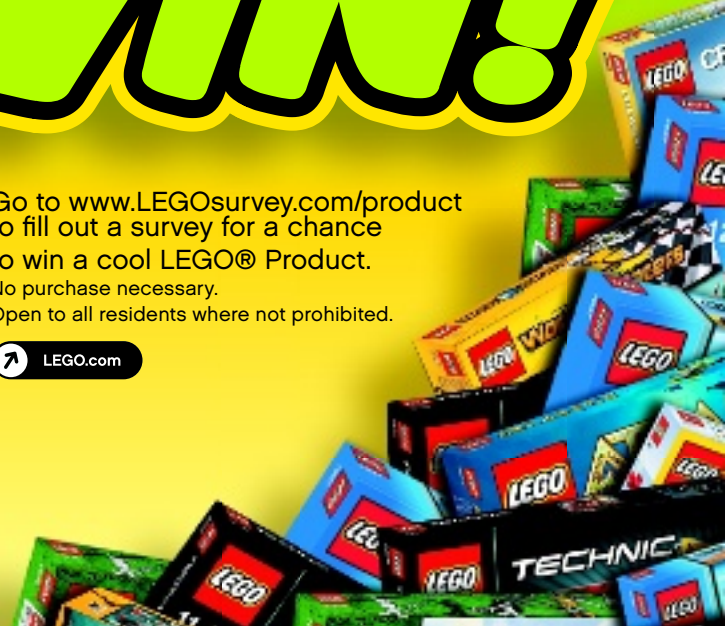

www.LEGOsurvey.com/product

GEWINNE! WIN!

Nimm an der Umfrage auf www.LEGOsurvey.com/product teil und hab die Chance ein cooles LEGO® Produkt zu gewinnen!

Die Teilnahme am Gewinnspiel führt zu keinerlei Kaufverpflichtungen. Teilnahme in allen nicht ausgeschlossenen Ländern möglich.

Ga naar www.LEGOsurvey.com/product, vul een enquêteformulier in en maak kans op een cool LEGO® product.

Geen aankoopverplichting. Iedereen mag deelnemen, uitgezonderd ingezetenden van landen waar een enquêteverbod geldt.

GAGNE! 当てよう!

Visite www.LEGOsurvey.com/product pour répondre à un questionnaire et avoir une chance de gagner un produit LEGO® très cool!

Aucune obligation d'achat. Ouvert à tous les résidents des pays autorisés.

www.LEGOsurvey.com/product にアクセスして、アンケートにご記入ください。当選者にはレゴ製品を差し上げます。

お買い上げの必要はありません。

禁止されていない限り、すべての皆様にご利用いただけます。