





[LEGO.com/sustainable-packaging](https://LEGO.com/sustainable-packaging)



# LEGO® VIP

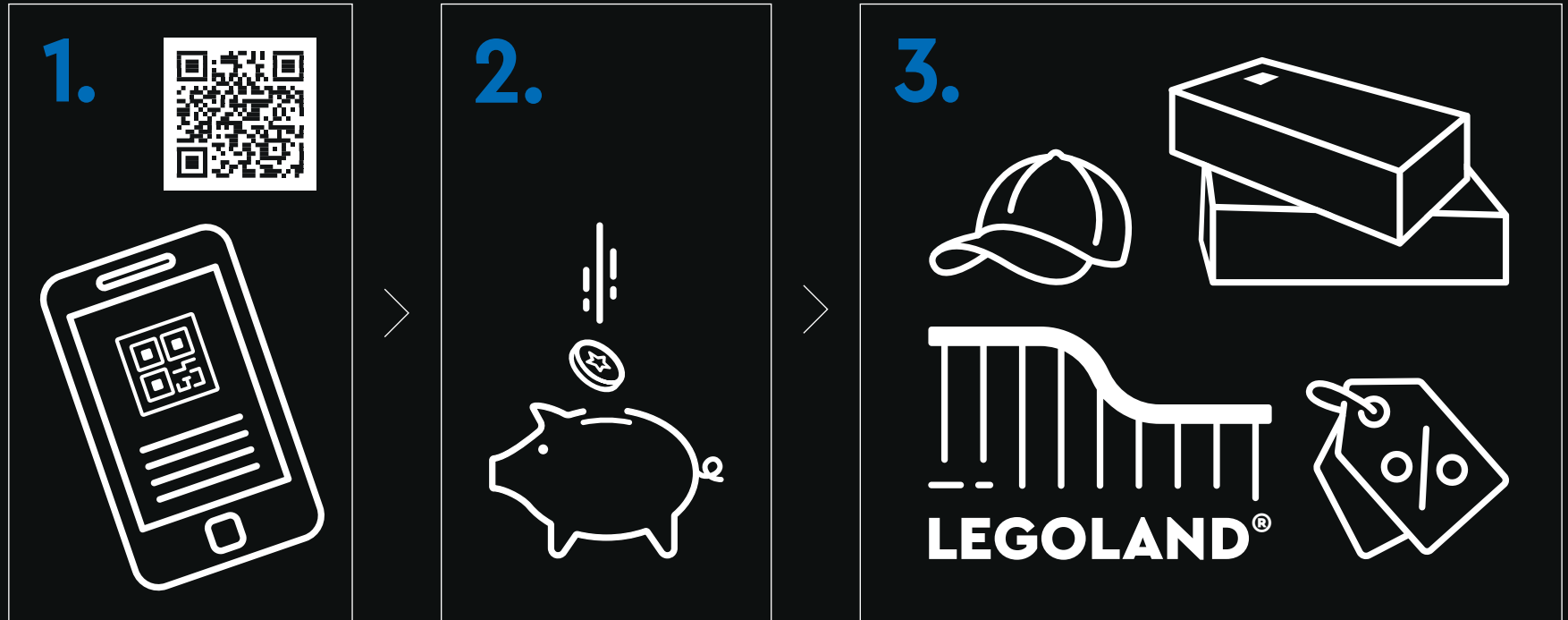

**1.** Sign up **2.** Earn points for purchases **3.** Redeem points for rewards, experiences, discounts & more | **1.** Melde dich an **2.** Sammle Punkte bei jedem Kauf **3.** Löse die Punkte für Belohnungen, Erlebnisse, Rabatte und Ähnliches ein | **1.** Inscrivez-vous **2.** Gagnez des points lors de vos achats **3.** Échangez vos points contre des récompenses, des expériences, des remises et bien plus encore | **1.** Iscriviti **2.** Guadagna punti con i tuoi acquisti **3.** Riscatta punti per premi, esperienze, sconti e altro ancora | **1.** Regístrate **2.** Gana puntos por tus compras **3.** Canjea puntos por recompensas, experiencias, descuentos y mucho más | **1.** Registe-se **2.** Ganhe pontos em compras **3.** Troque os pontos para prémios, experiências, descontos e muito mais | **1.** 注册 **2.** 购物赚积分 **3.** 用积分兑换奖励、体验、折扣等 | **1.** Zarejestruj się **2.** Zdobywaj punkty za zakupy **3.** Wymieniaj punkty na rabaty, przygody i inne nagrody | **1.** Zaregistrujte se **2.** Sbírejte body za nákupy **3.** Vyměňujte body za odměny, zážitky, slevy a spoustu dalšího | **1.** Zaregistrujte se **2.** Získavajte body za nákupy **3.** Uplatnite si body a získajte odmeny, rôzne zážitky, zľavy a ešte viac | **1.** Regisztrálj **2.** Szerezz pontokat minden vásárlással **3.** Váltsd be pontjaidat jutalmakra, élményekre, kedvezményekre és egyebekre | **1.** Înscric-te **2.** Câștigă puncte pentru achiziții **3.** Valorifică puncte pentru recompense, experiențe, reduceri și multe altele | **1.** Регистрируйте се **2.** Получайте точки за покупки **3.** Используйте точки за награды, услуги, отстъпки и т.н. | **1.** Reģistrējies **2.** Pelnī punktus par pirkumiem **3.** Izmanto punktus, lai saņemtu balvas, izklaides iespējas, atlaides un daudz ko citu | **1.** Registreeru **2.** Teeni ostude eest punkte **3.** Lunasta punktide eest preemiad, elamused, allahindlused ja muu | **1.** Užsiregistruokite **2.** Pelnkite taškus už pirkinius **3.** Panaudokite taškus atlygiui, funkcijoms, nuolaidoms ir ne tik







# 姫路城

## BURG HIMEJI – DIE WEISSER-REIHER-BURG

Die atemberaubende Burg Himeji thront majestätisch über der gleichnamigen japanischen Stadt. Als architektonisches Juwel hat sie es zudem auf die UNESCO-Liste der Weltkulturgüter geschafft. Die Burg wurde im Jahr 1333 gegen Ende der Ära der Bürgerkriege zunächst als Festungsanlage errichtet. Im Laufe der Jahrhunderte erfolgten dann einige Umbaumaßnahmen. Im Jahr 1600 begann ein größerer Umbau, aus dem das heutige Bauwerk hervorging, das in seiner Gesamtheit bis heute erhalten wurde. Dafür sorgten erst die dort ansässigen Feudalherren und später die japanische Regierung. Raffiniert zu Labyrinthen verschachtelte Gänge sollten Feinde in die Irre und in eine Falle führen. Heute faszinieren diese verflochtenen Wege die vielen Besucher. Die Weißer-Reiher-Burg hat Kriege, Erdbeben, Brände und friedliche Zeiten überstanden und ist heute ein Denkmal der japanischen Kultur. Entdecke beim Bauen die feinen Details des Hauptburgfrieds sowie die Geschichte der Burg.

CHRIS MCVEIGH  
LEGO® Senior Designer

## HOMMAGE AN EIN VEREHRTES WAHRZEICHEN

🌸 „Im Jahr 2023 jährt sich die Aufnahme der Burg Himeji in die UNESCO-Liste der Weltkulturgüter zum 30. Mal. Doch ihre Architektur und ihre Geschichte bergen immer noch viele Geheimnisse. Wir haben den Hauptburgfried als natürlichen Mittelpunkt nachgebildet und mit den Proportionen und dem Maßstab gespielt, um ihn besonders hervorstechen zu lassen. Wer die Burg schon besucht hat, wird vermutlich einen Teil des Innenlebens wiedererkennen. Und falls du dir die Burg noch nicht mit eigenen Augen ansehen konntest, werden wir mit diesem Modell hoffentlich deine Fantasie und Neugier wecken.“







*Folge einigen der verschachtelten Gänge,  
Aufgänge und Treppen durch die Burg.*





## EINE OPTISCHE TÄUSCHUNG

Das Dach der Burg Himeji ist mit ineinandergreifenden rechteckig-halbkreisförmigen schwarzen Dachziegeln gedeckt. Mehrere Schichten weißer Ton umrahmen die Dachziegel und bilden einen starken Kontrast. Aus der Nähe betrachtet wirkt das Dach deshalb wie ein Netz. Aus größerer Entfernung hat es jedoch den Anschein, die Burg hätte ein graues Dach. Die Dachziegel in diesem Set sind *dunkelsteingrau*, um die Verwitterung der Ziegel widerzuspiegeln.





*Blick ins Innere des fertigen Modells.*



*Jeder Turm ist anders konstruiert - und sogar unterschiedlich hoch.*



*Ungleiche Winkel sind in der ganzen Burg und auch an ihren Mauern vorherrschend.*

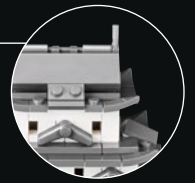

*Aus der Entfernung sieht es so aus, als hätte die Burg ein graues Dach. Ein „Netz“ aus schwarzen Ziegeln und weißem Ton erzeugt diese optische Täuschung.*

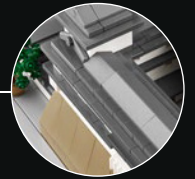

*Jede Ebene oder Etage im Hauptburgfried greift die eigentliche Struktur der Burg auf.*



*Verziere die Kirschbäume mit rosafarbenen Blüten oder grünen Blättern.*

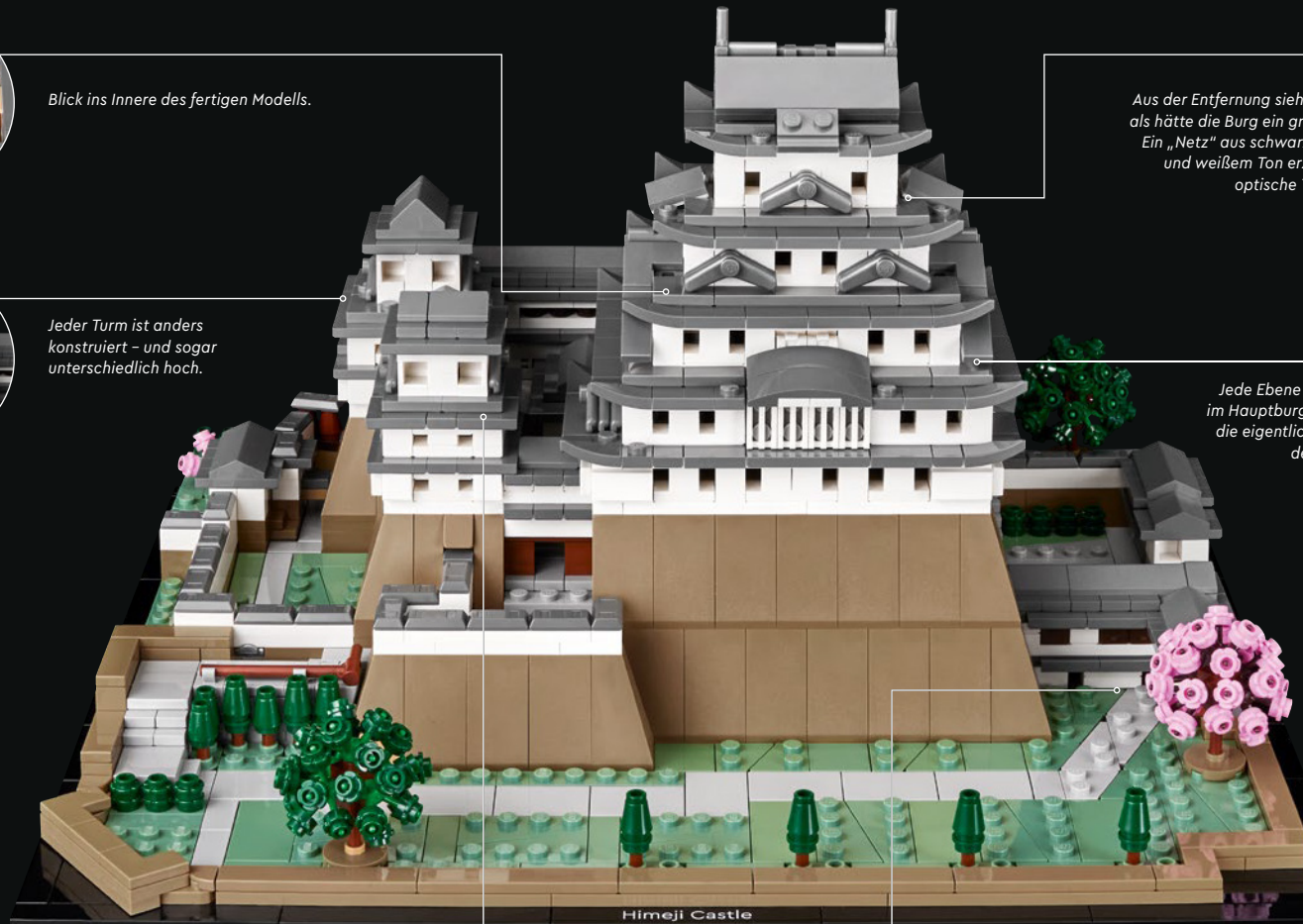

Himeji Castle

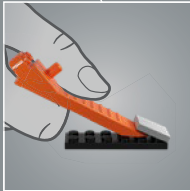
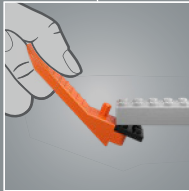
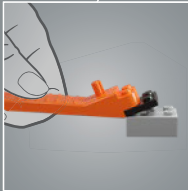
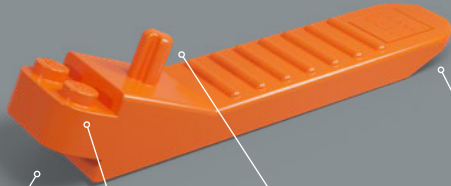



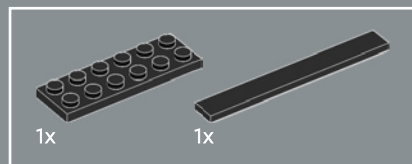

1

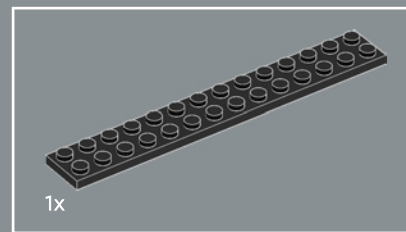
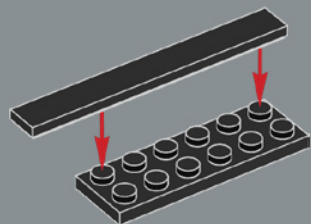

2

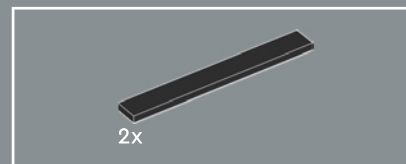
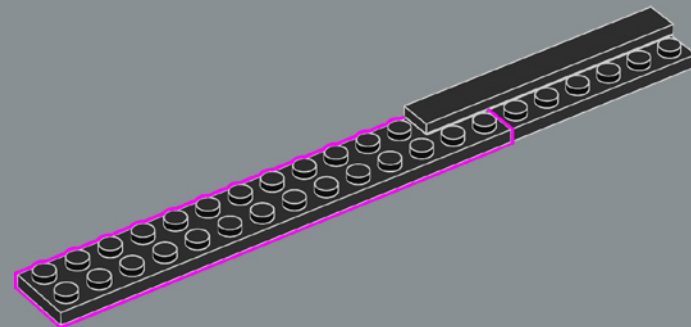

3

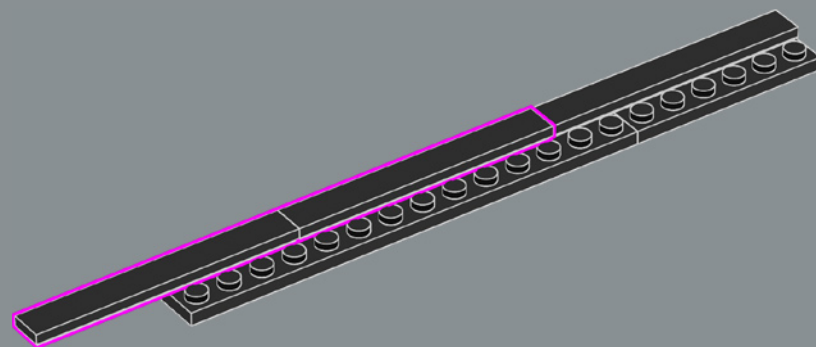

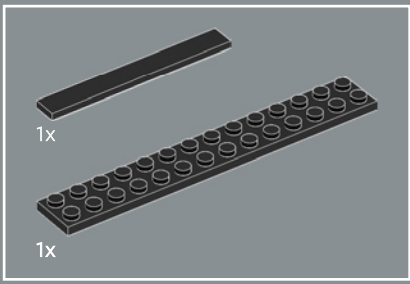

4

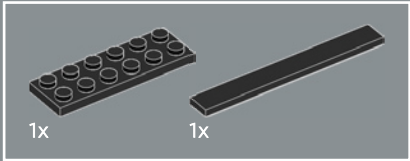
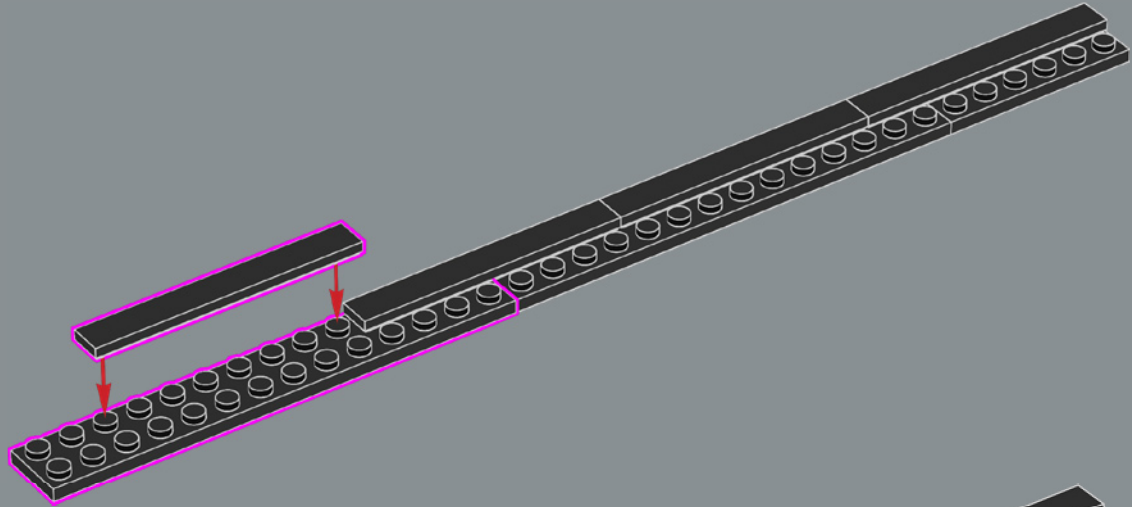

5

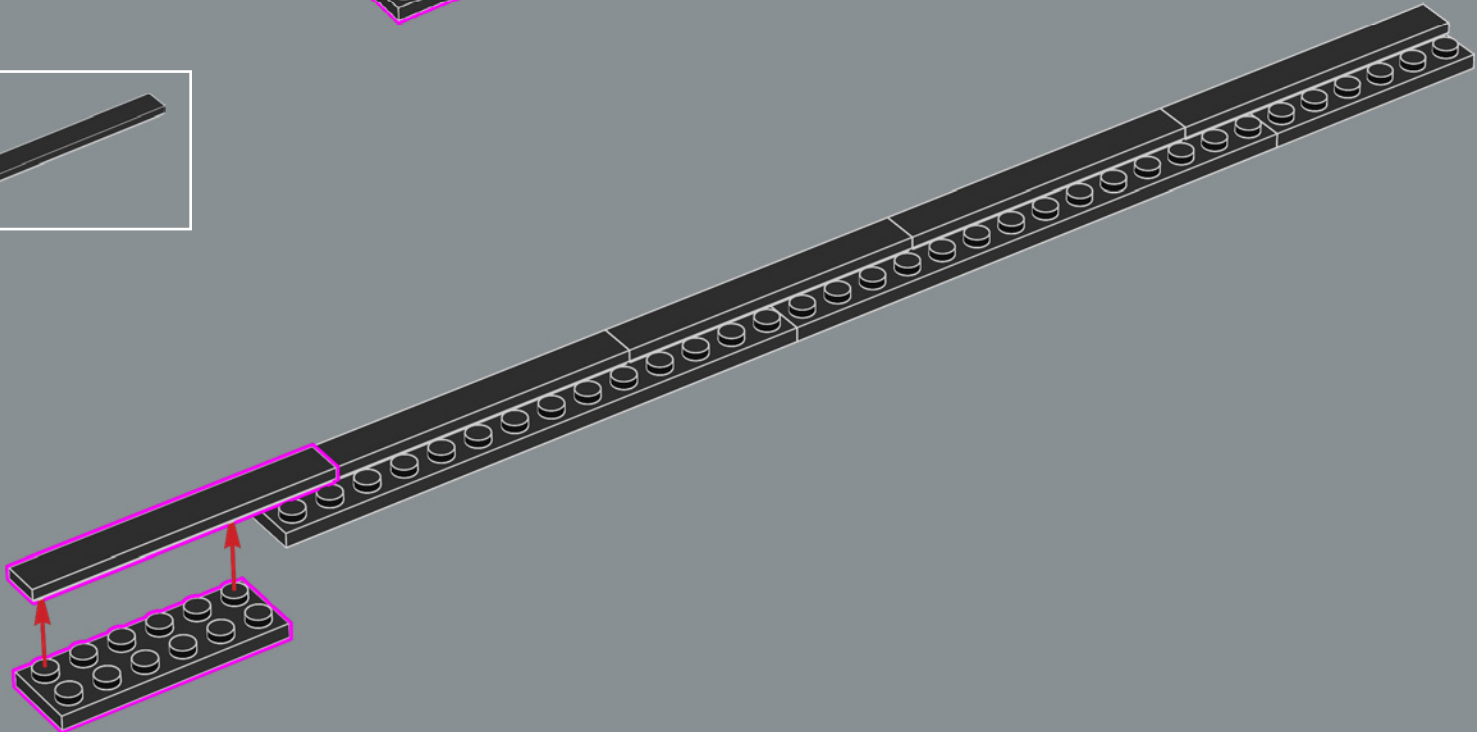



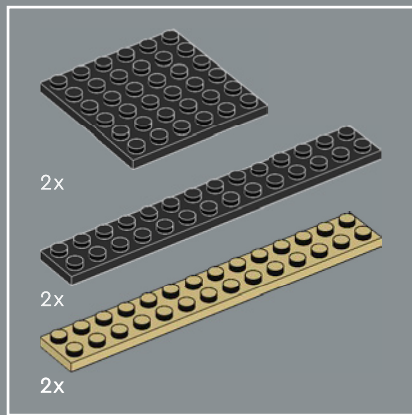

6

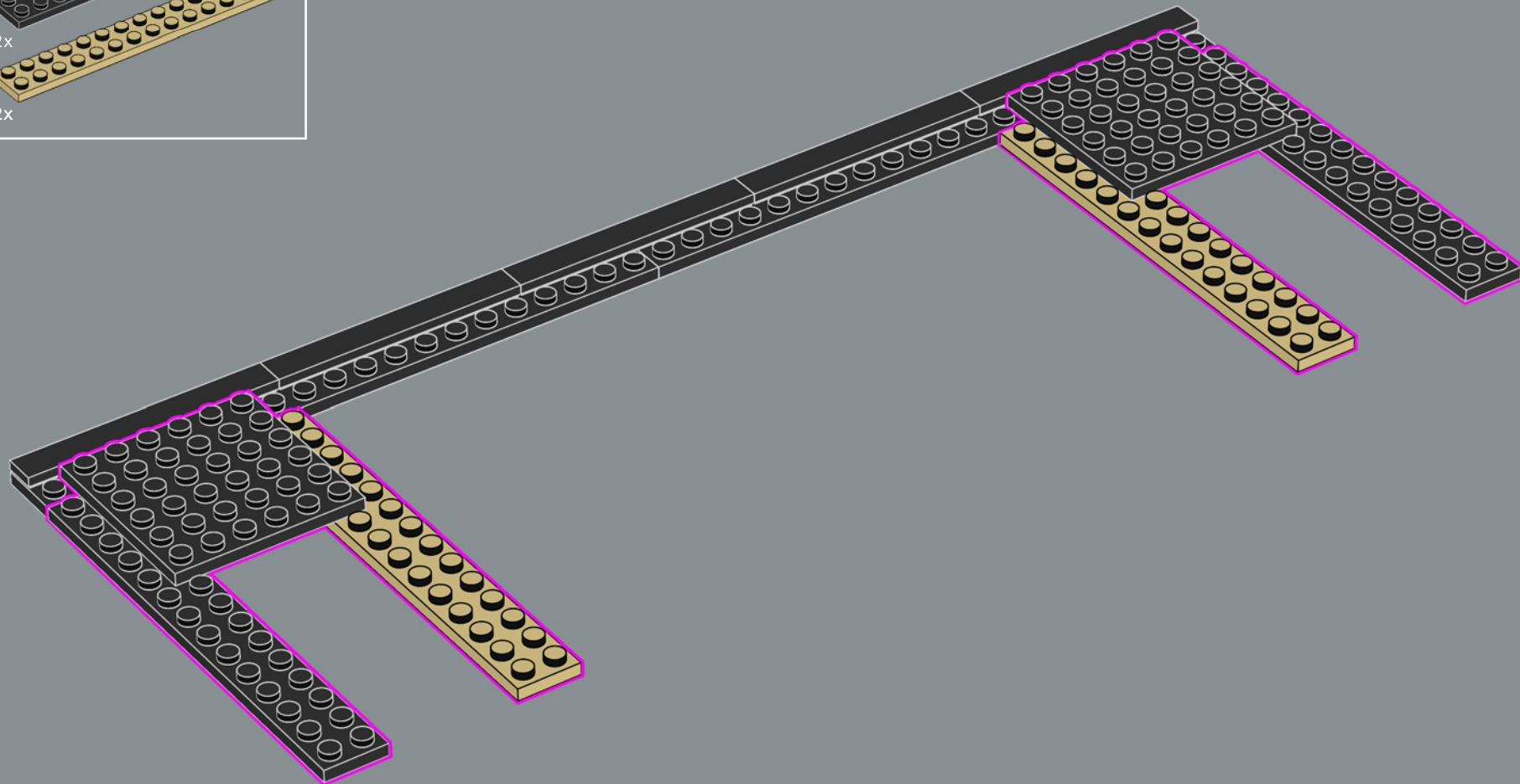

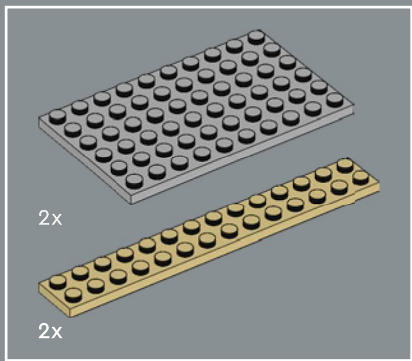

7

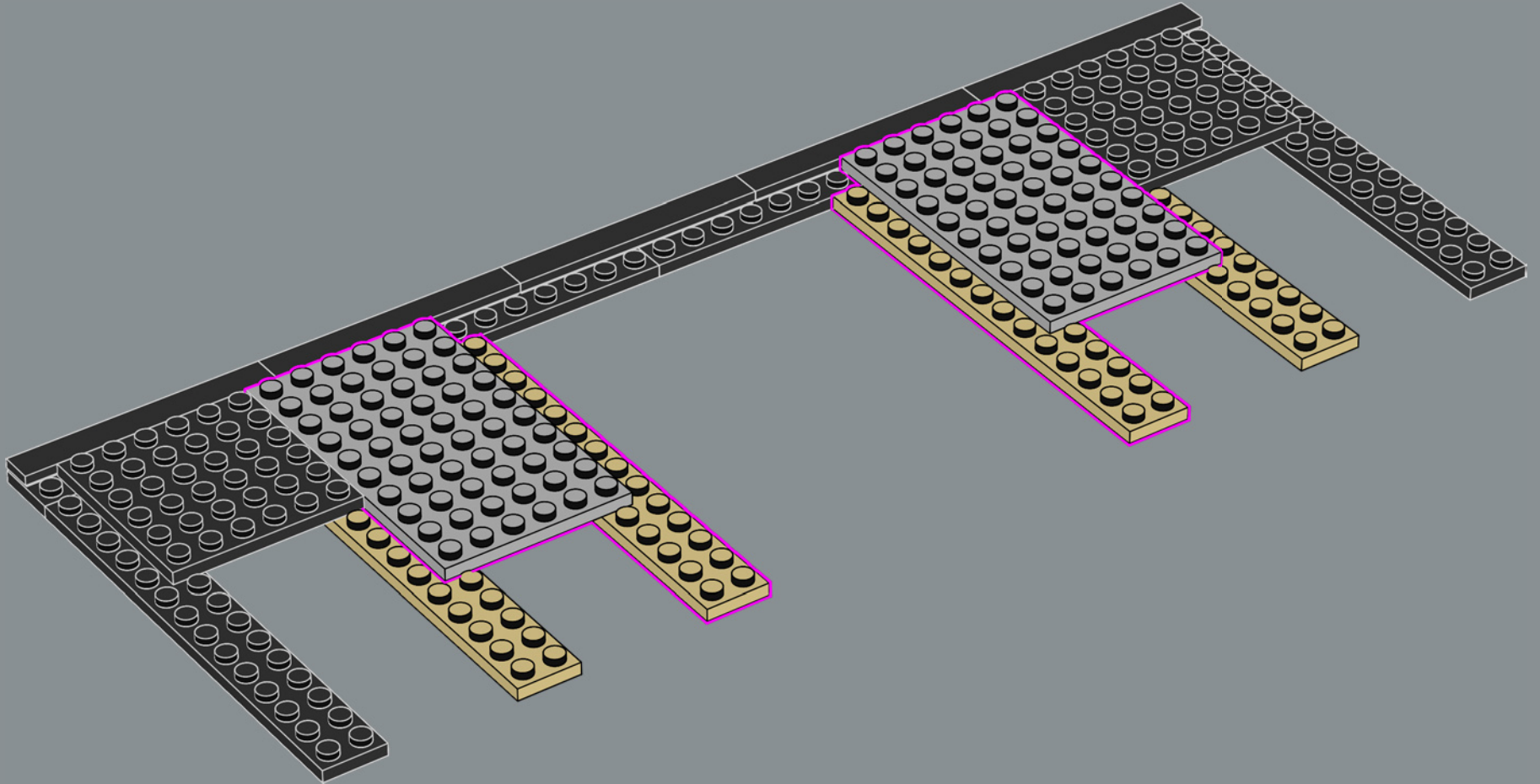

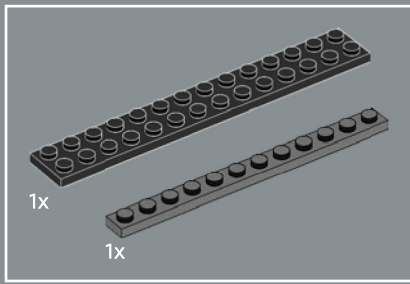

8

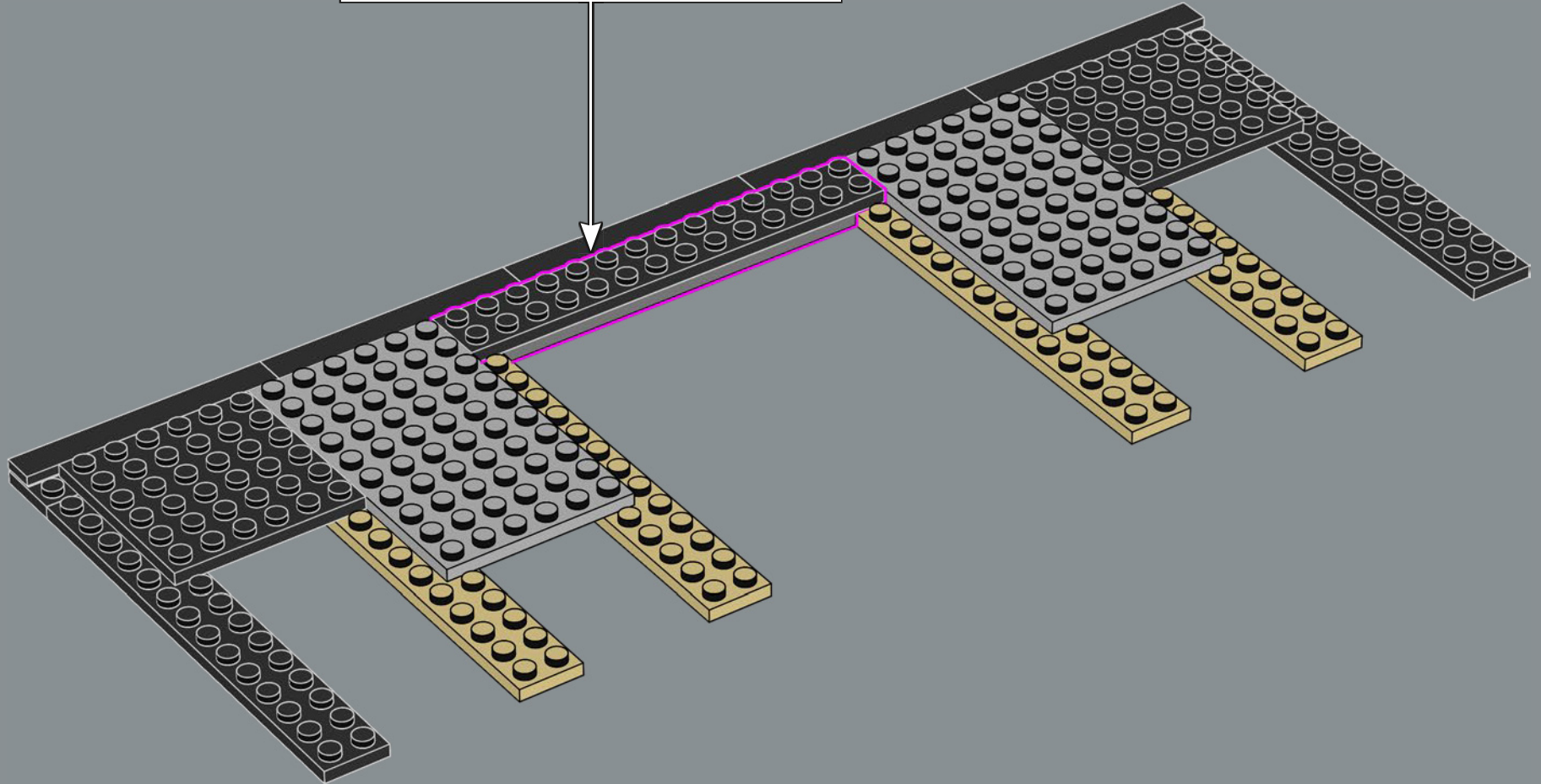
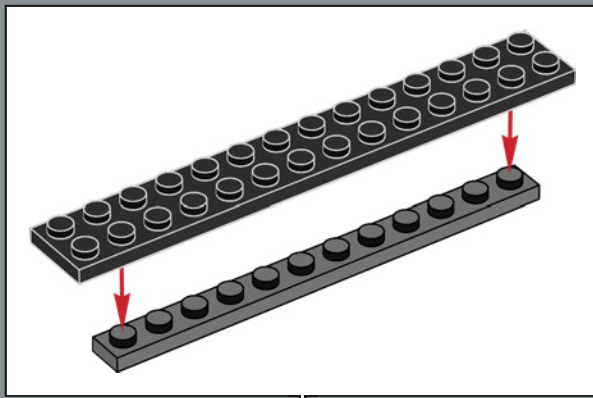



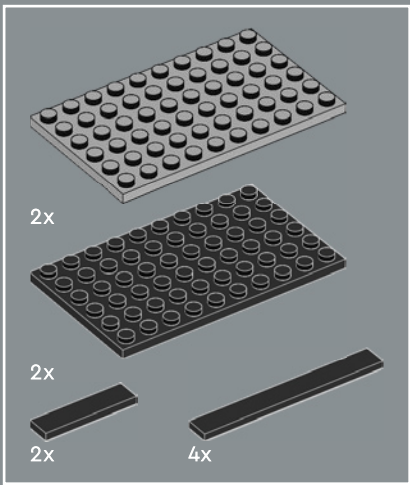

9

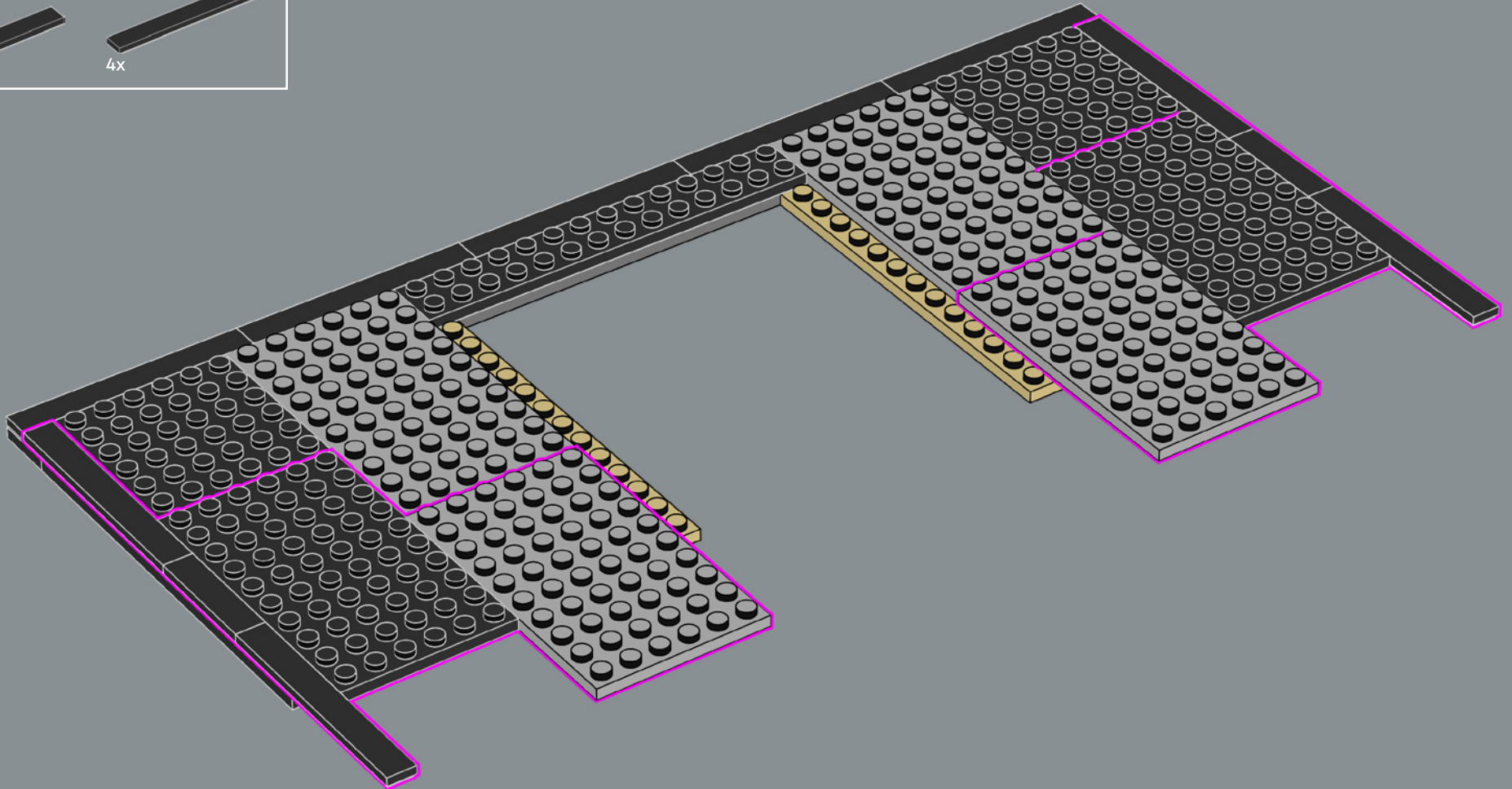

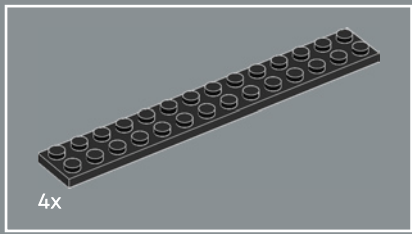

10

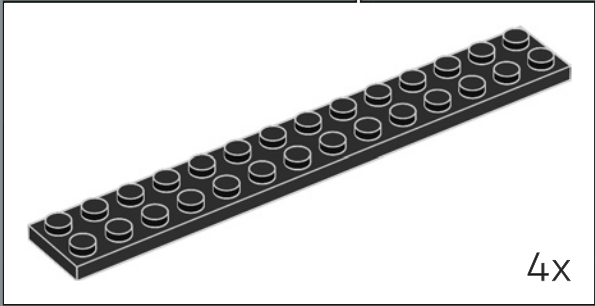
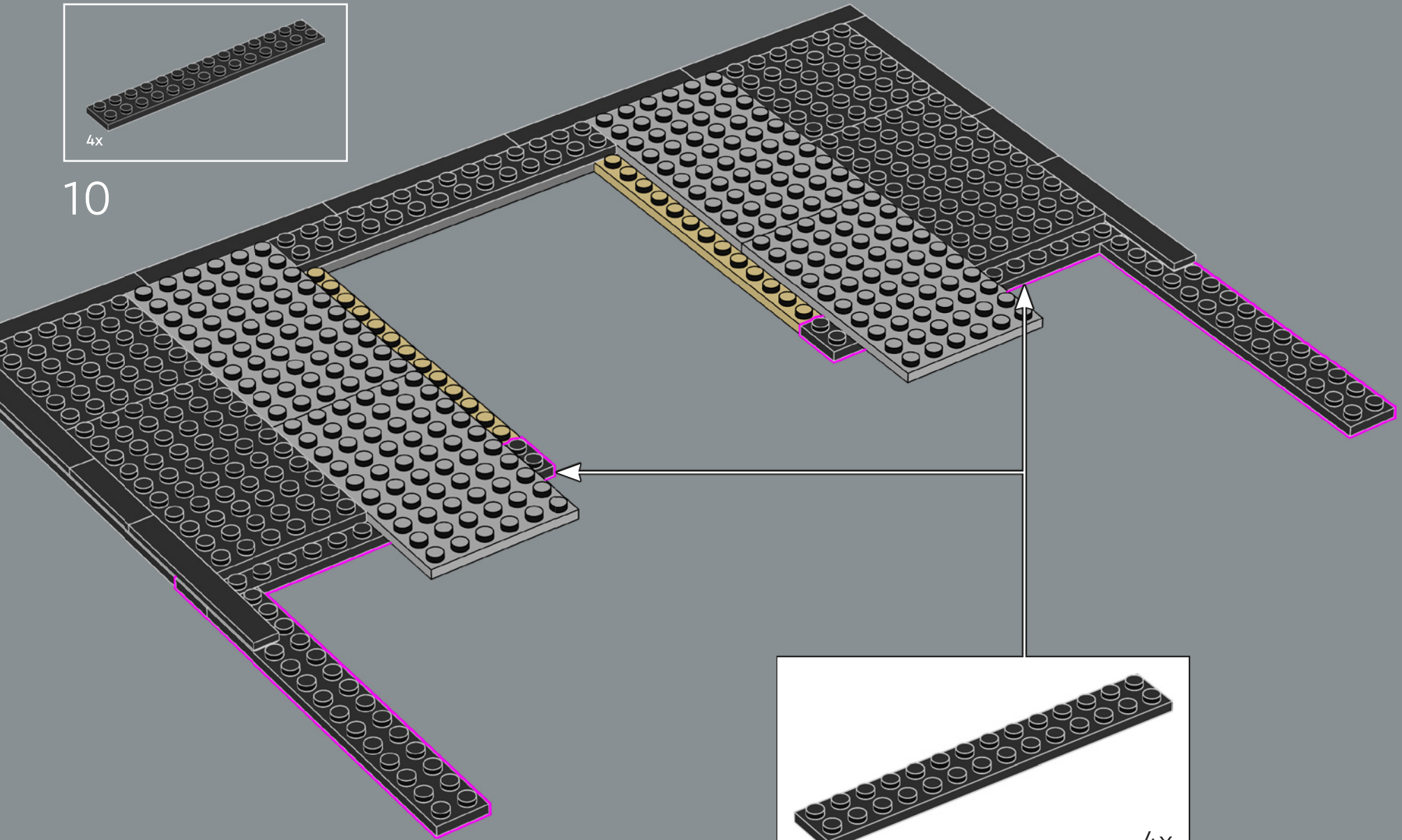

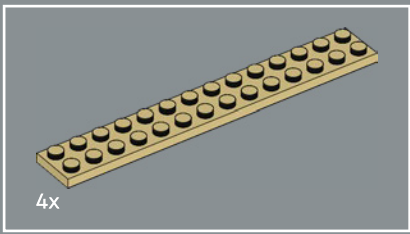

11

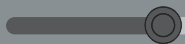
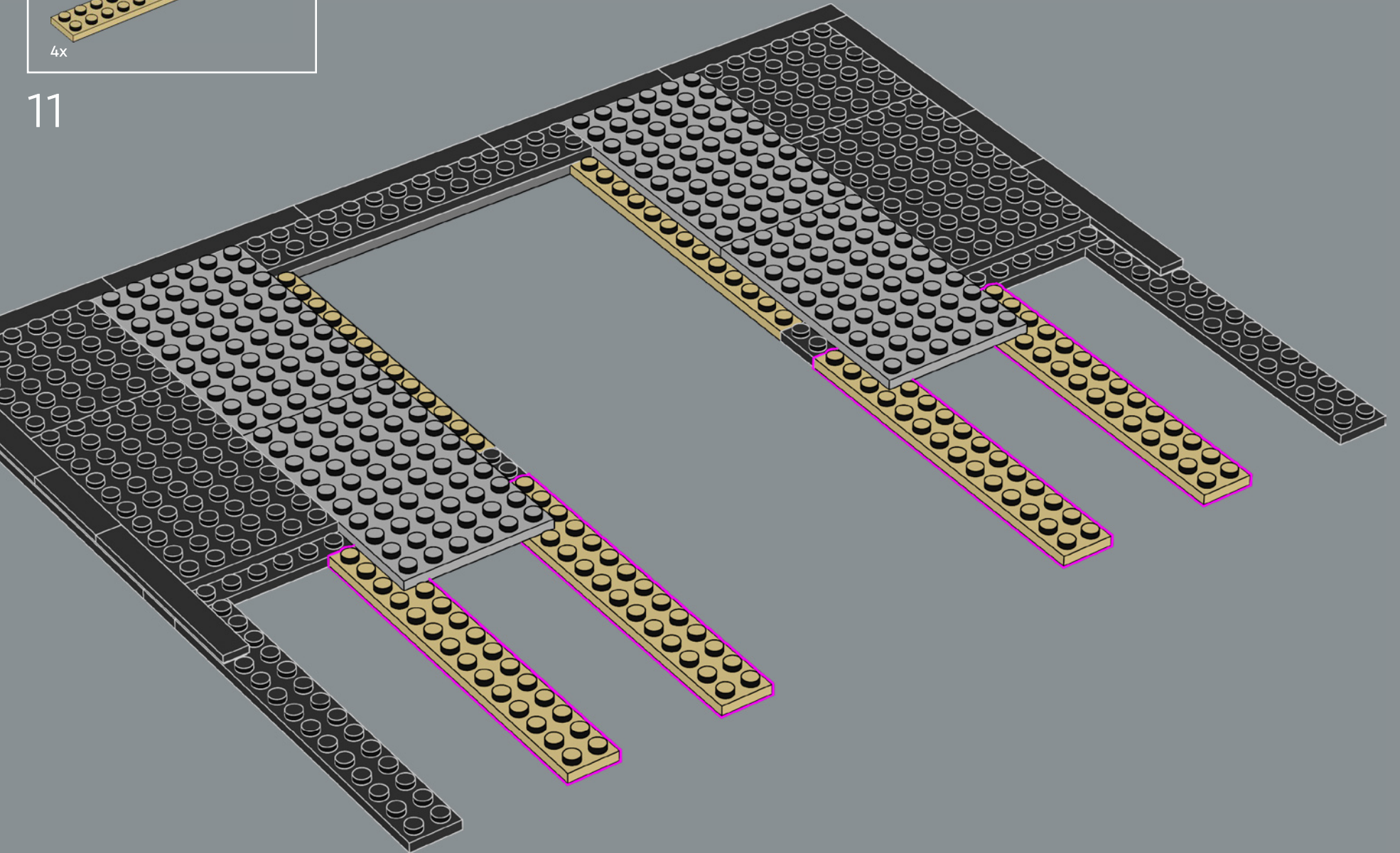



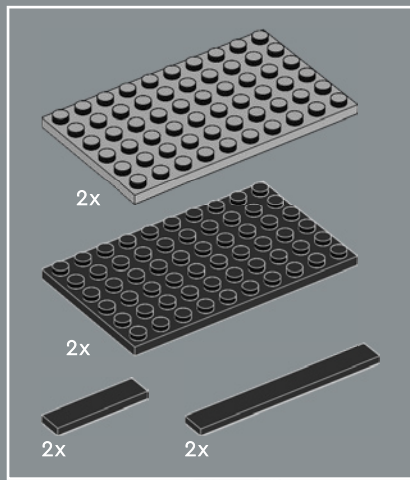

12

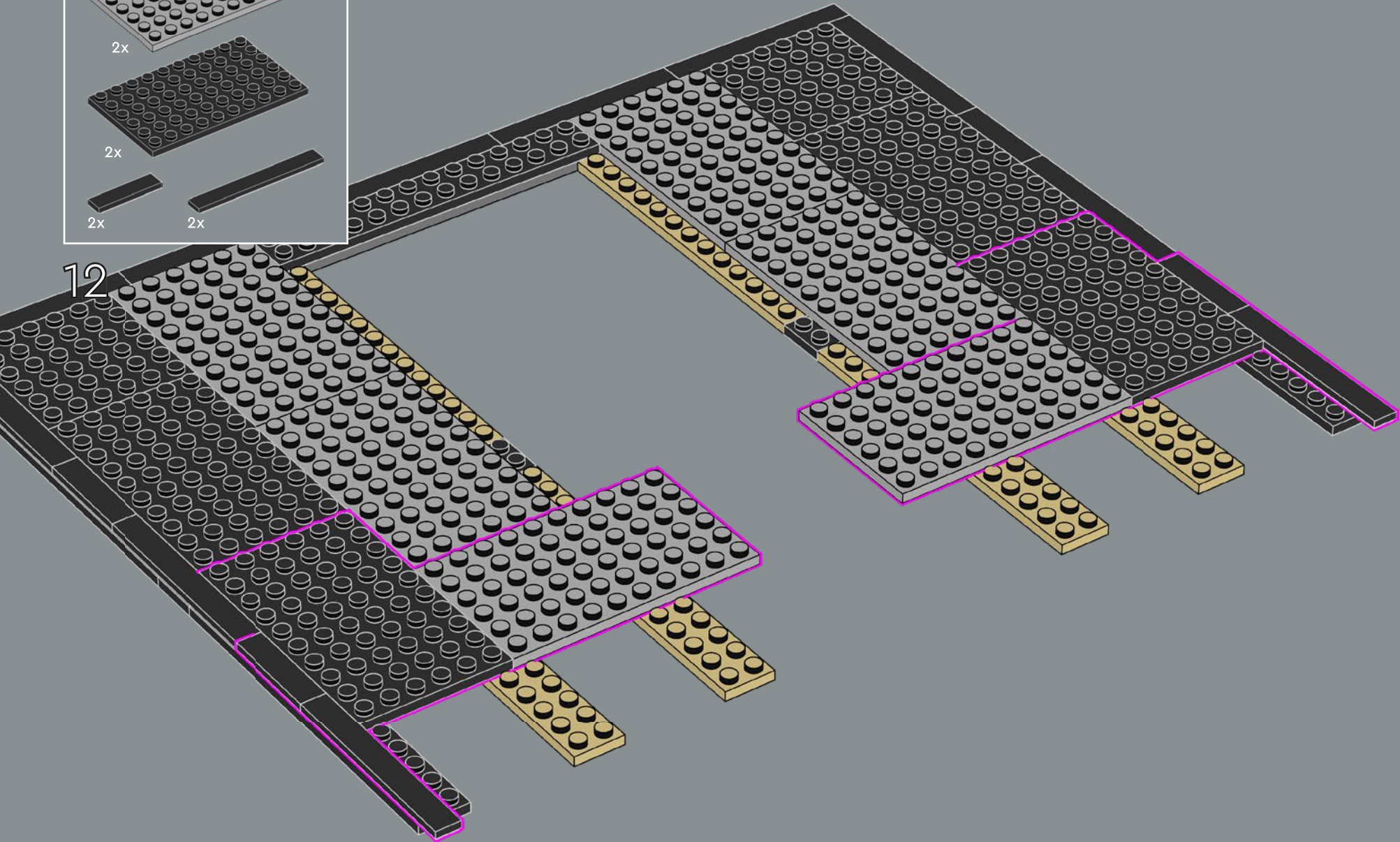

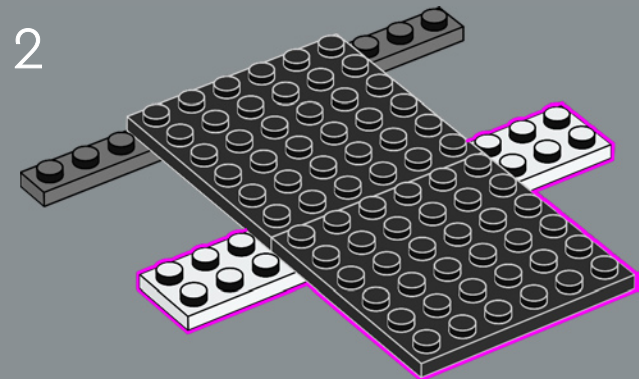
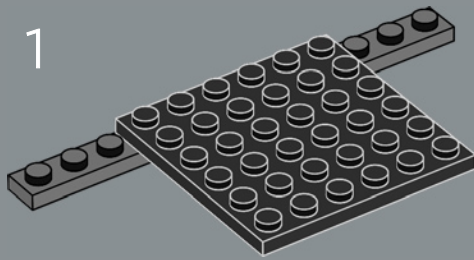
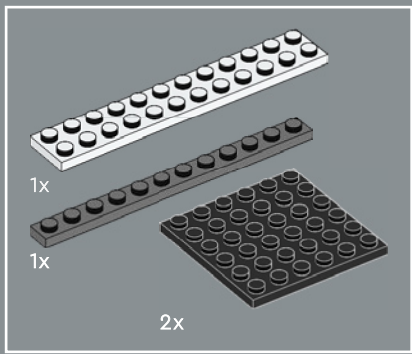

13

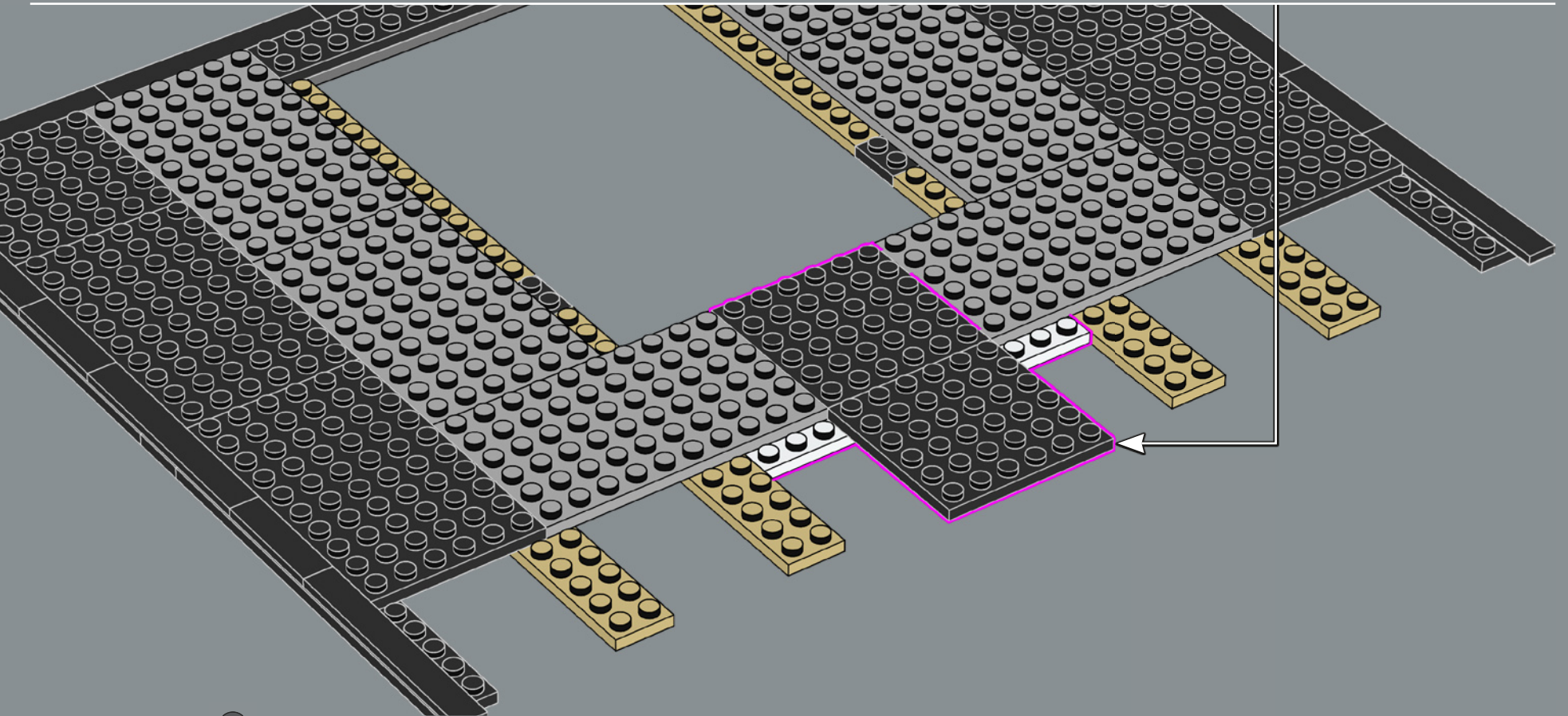



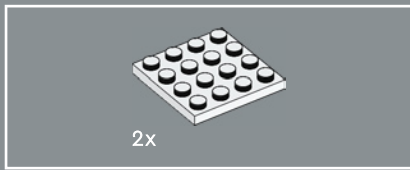

14

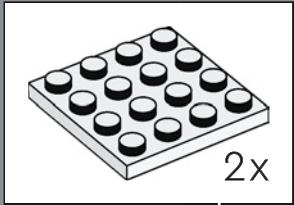
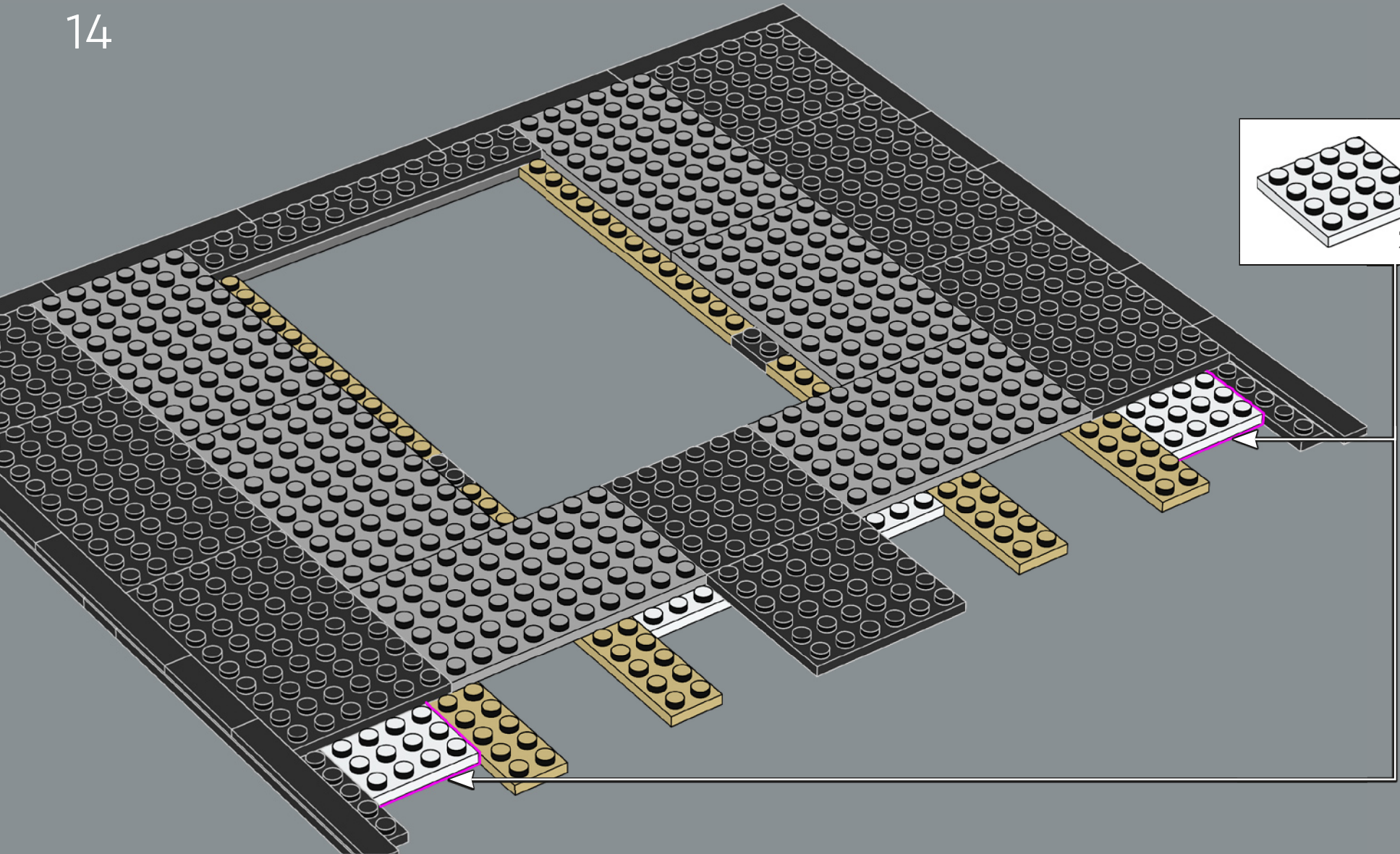



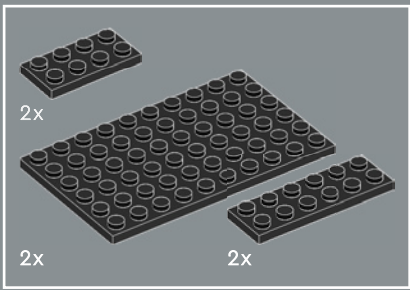

15

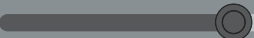
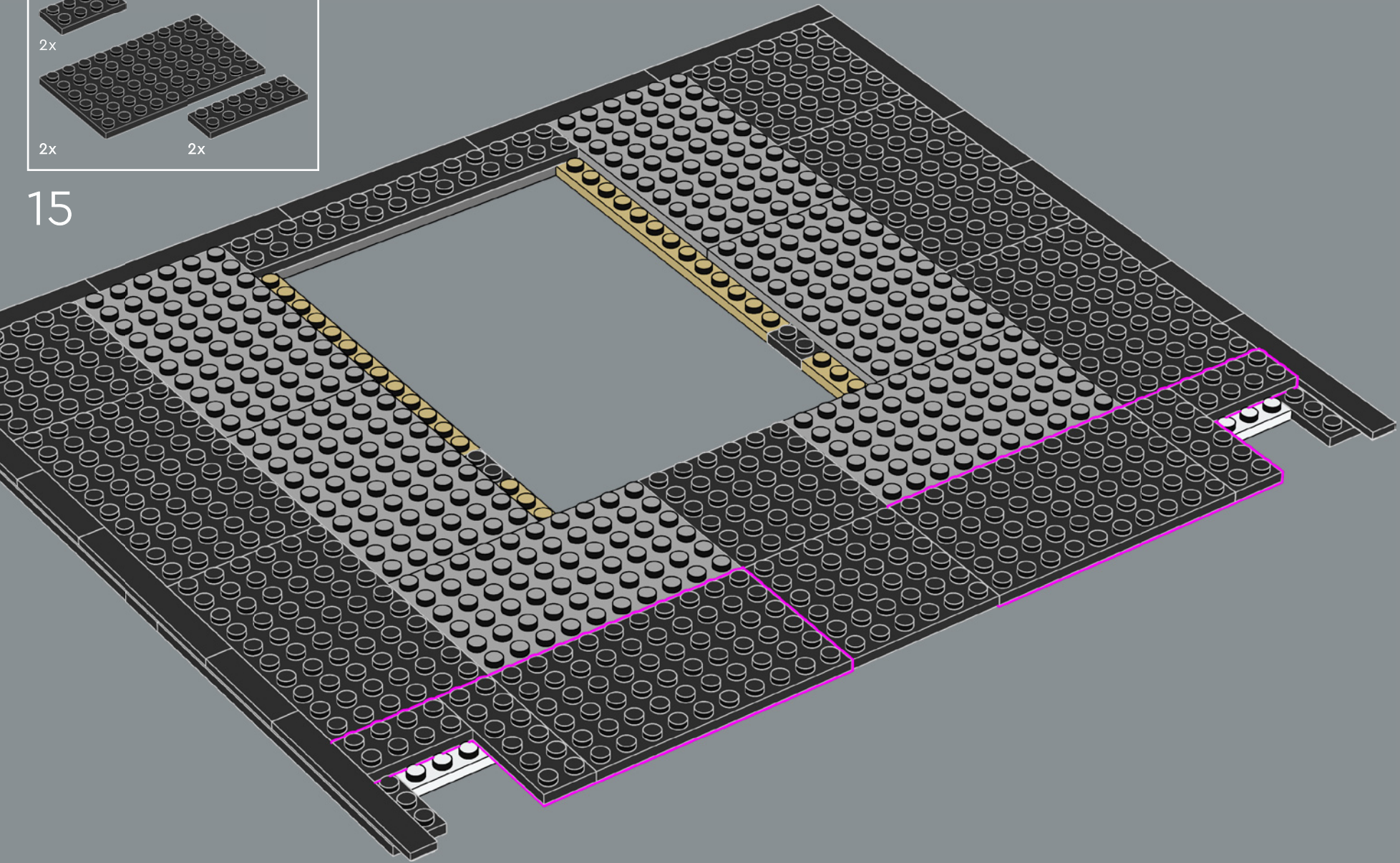





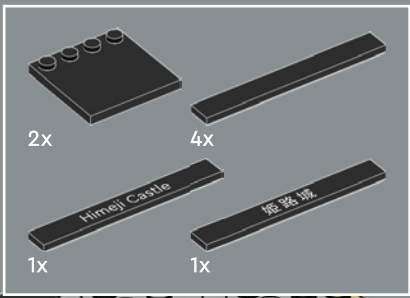

17

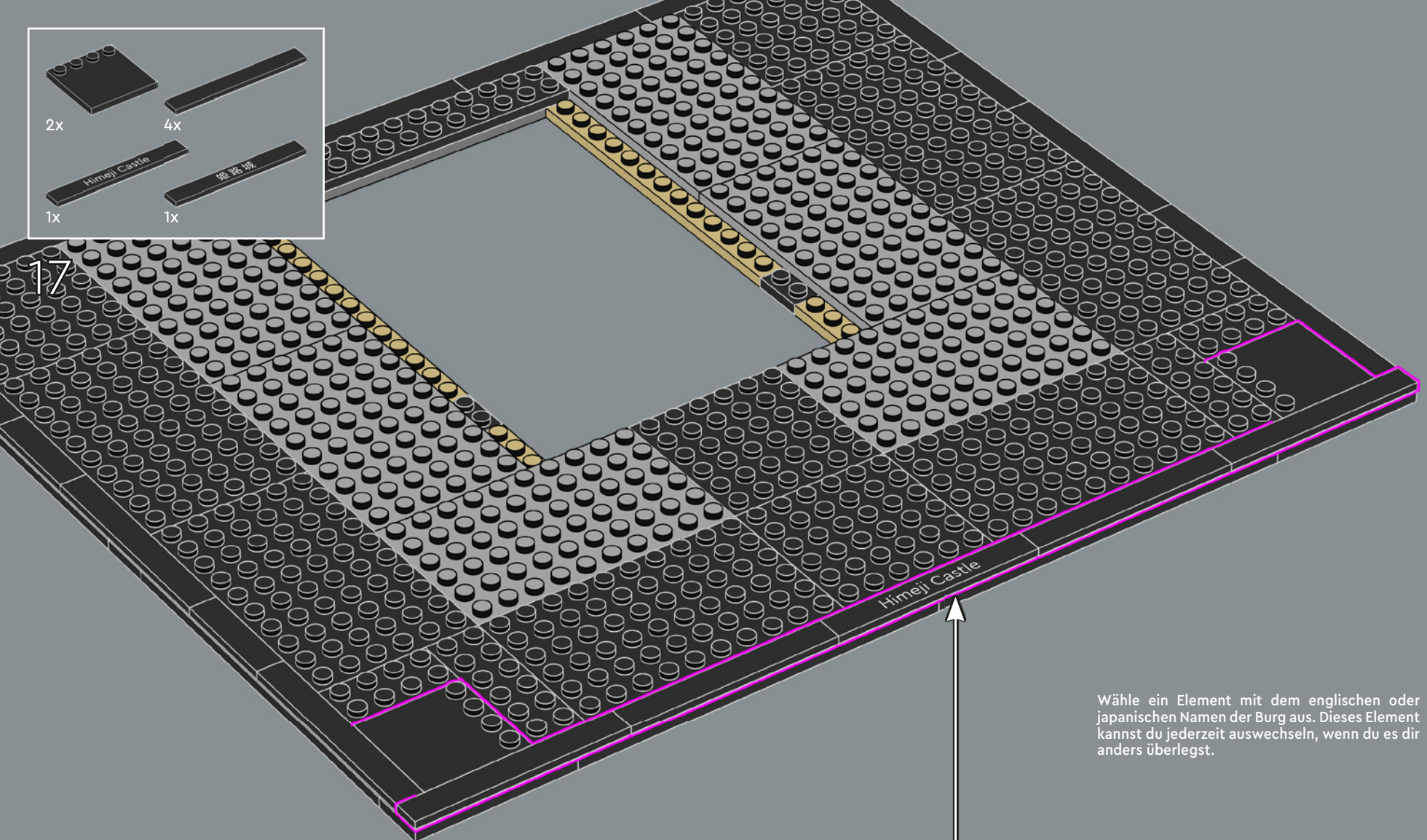

Wähle ein Element mit dem englischen oder japanischen Namen der Burg aus. Dieses Element kannst du jederzeit auswechseln, wenn du es dir anders überlegst.

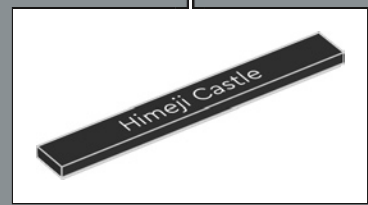



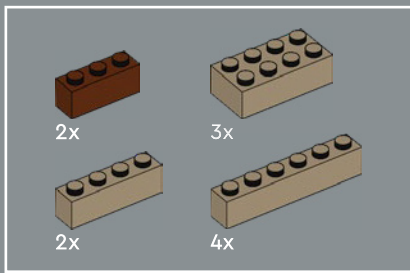

18

1993 wurde die Burg Himeji in die UNESCO-Liste der Weltkulturgüter aufgenommen, um das Wahrzeichen als architektonisches Meisterwerk und Gipfel japanischer Holzbaukunst zu würdigen.

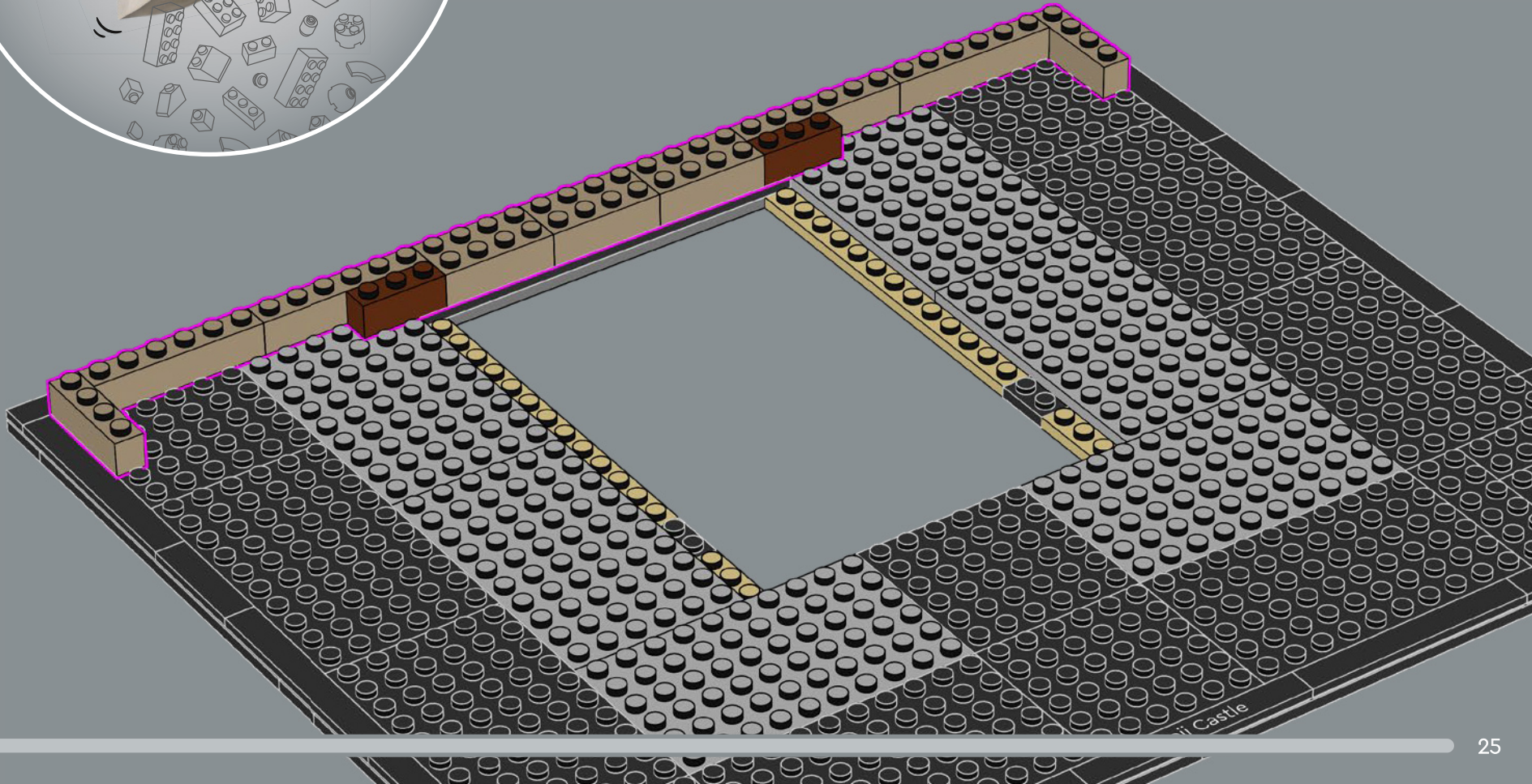



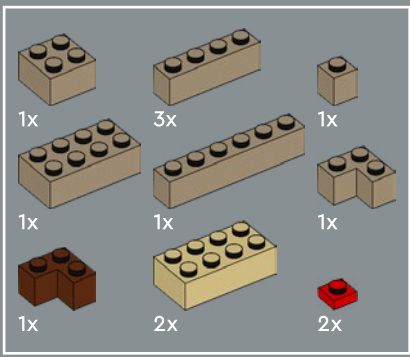

19

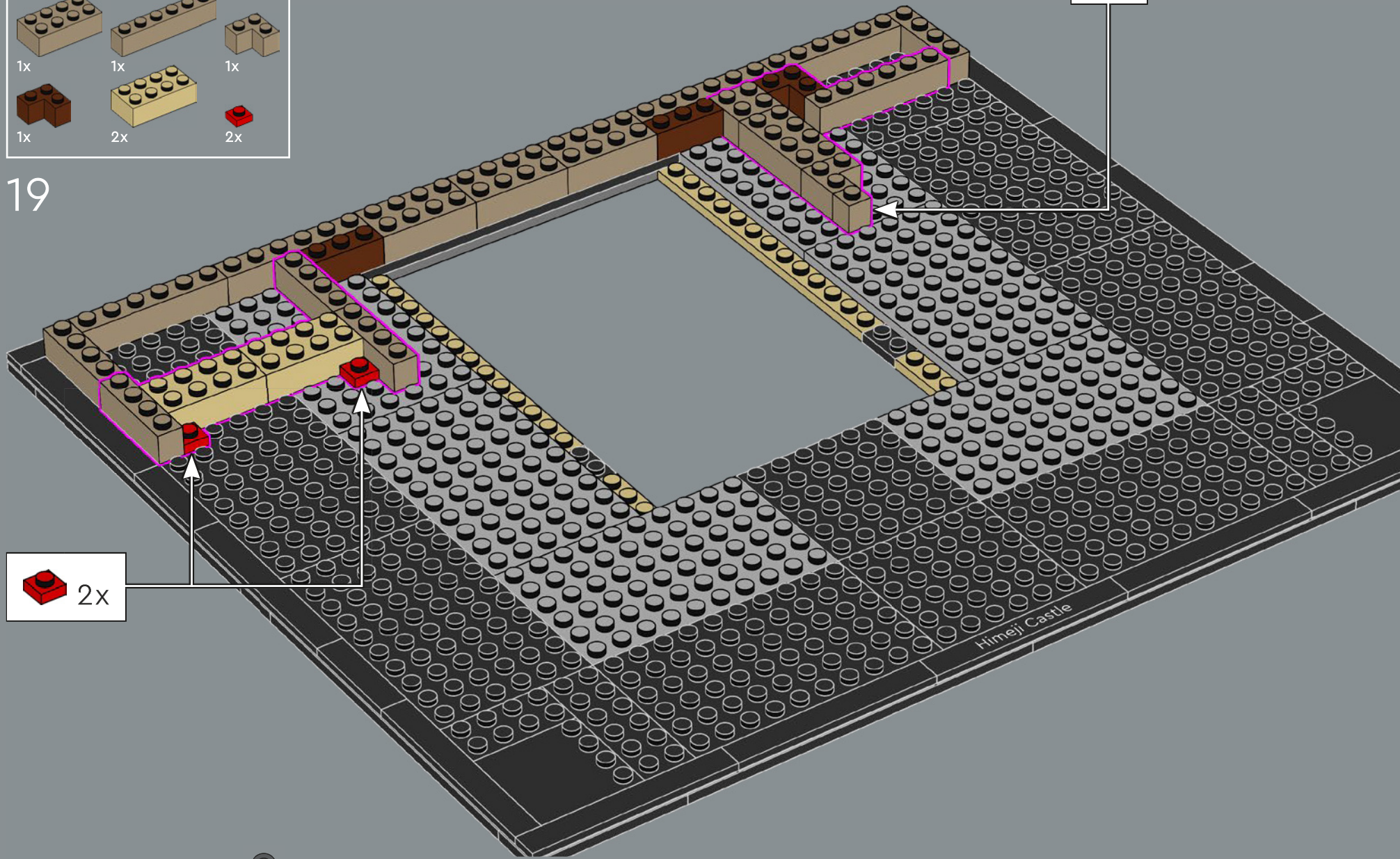



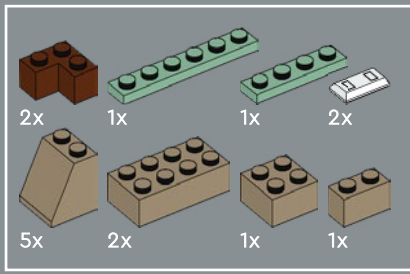

20

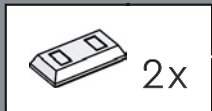
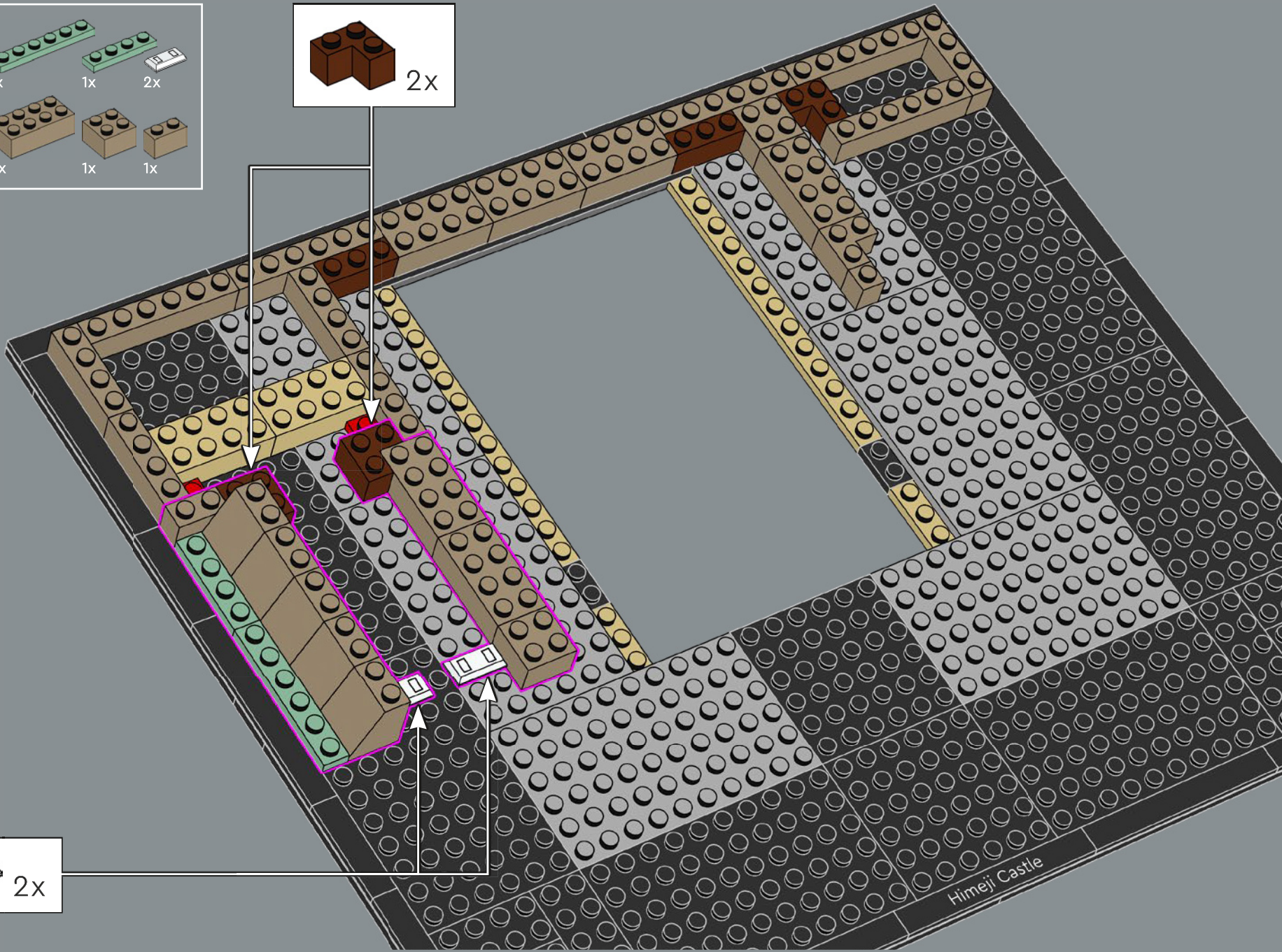



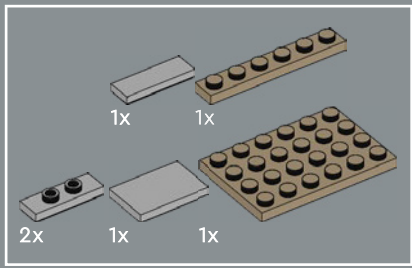

21

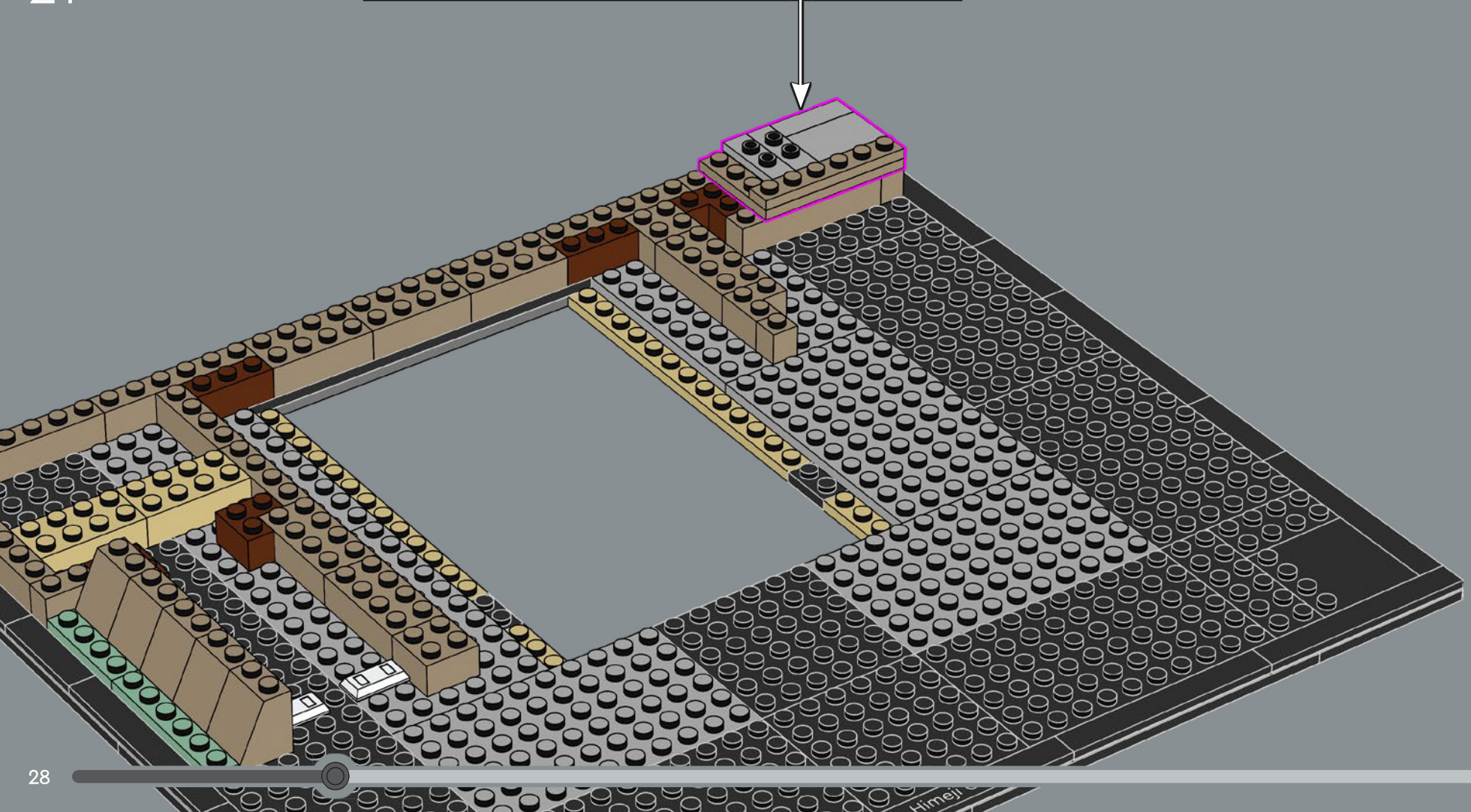
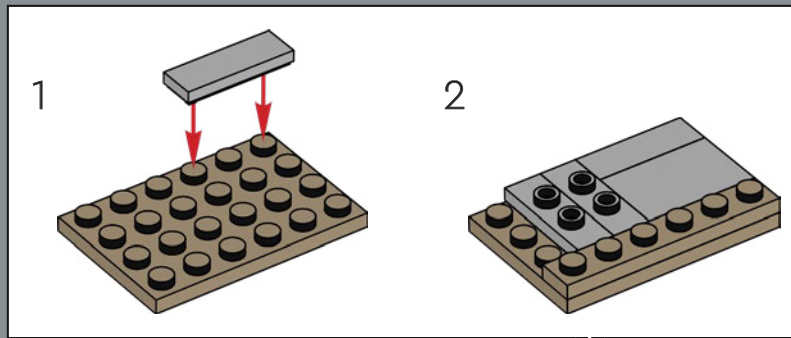

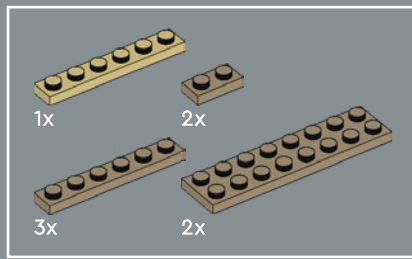



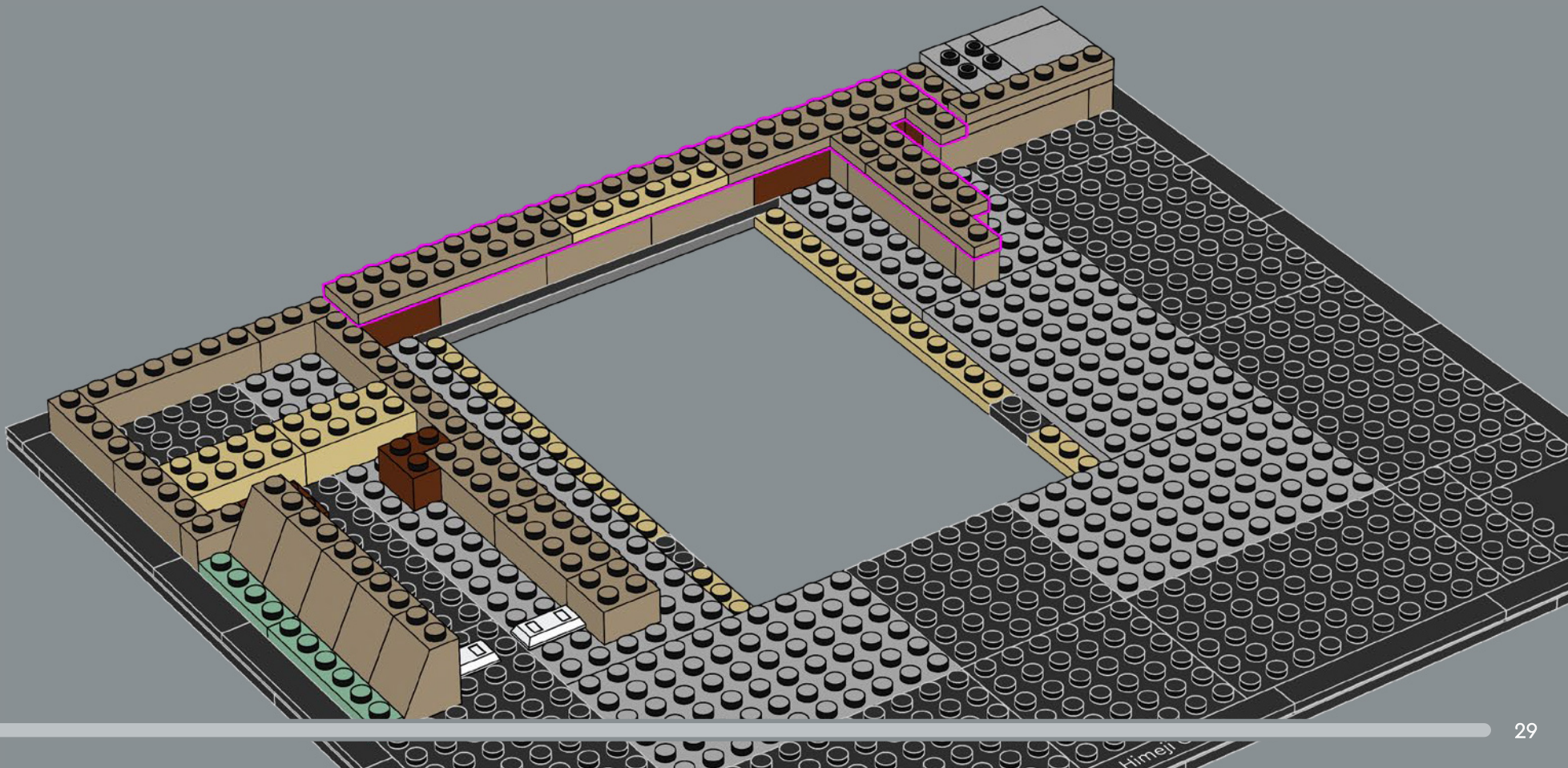

22





- 1x 
- 1x 
- 2x 
- 2x 
- 1x 

23

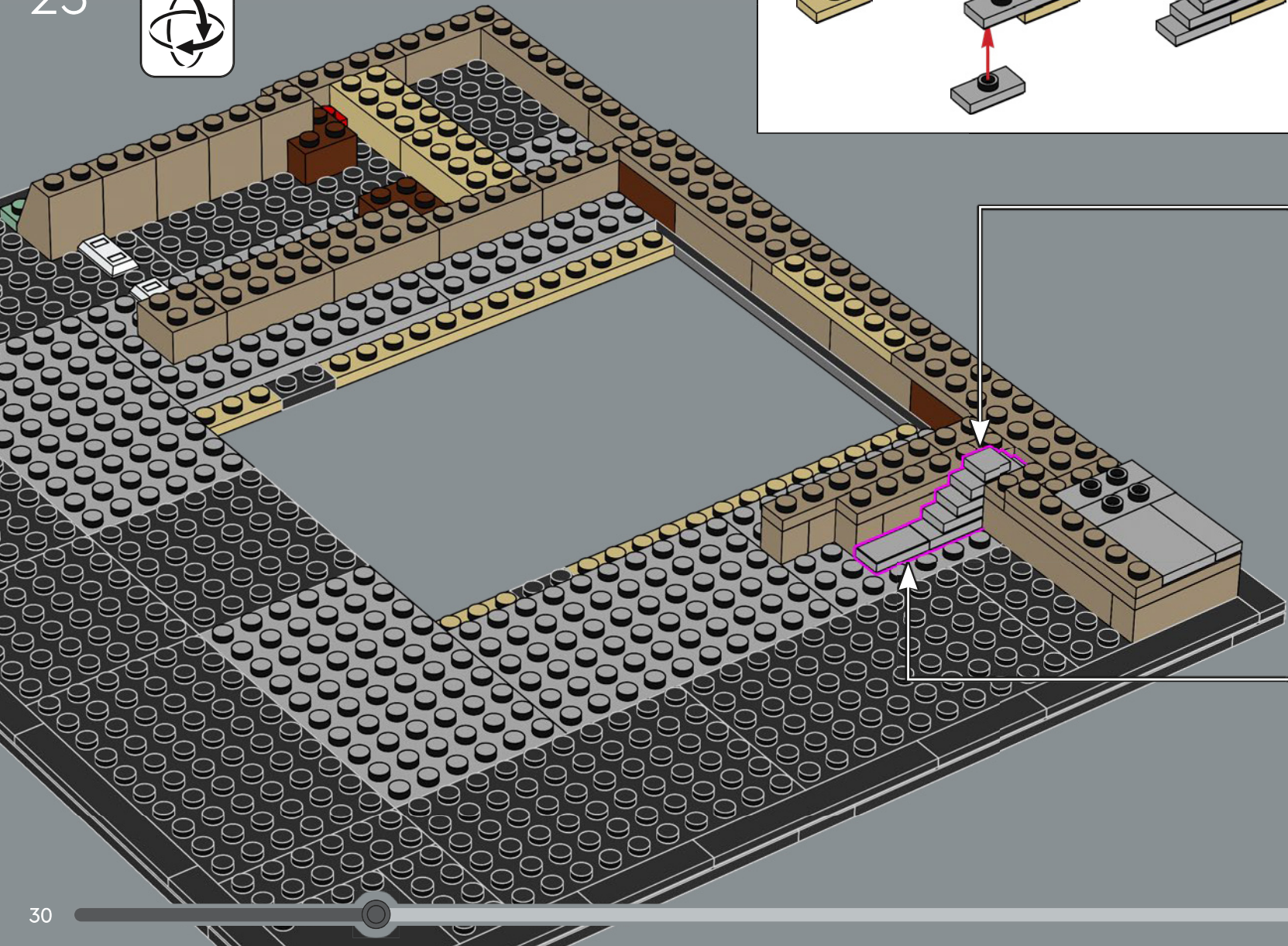
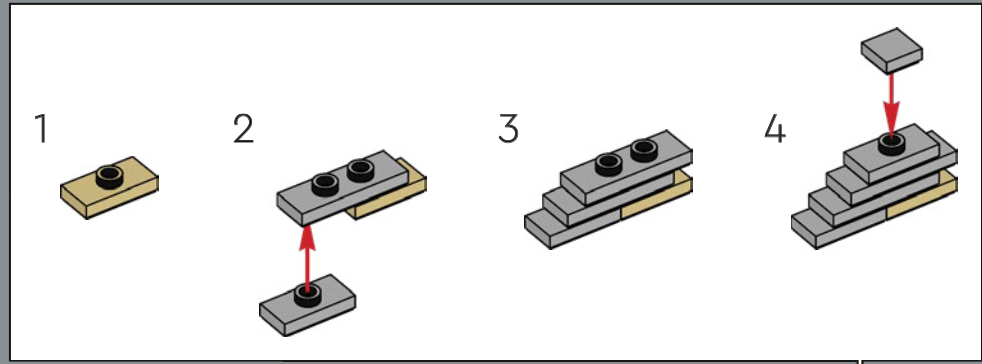



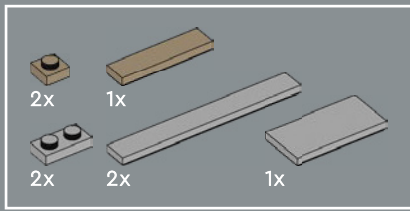

24

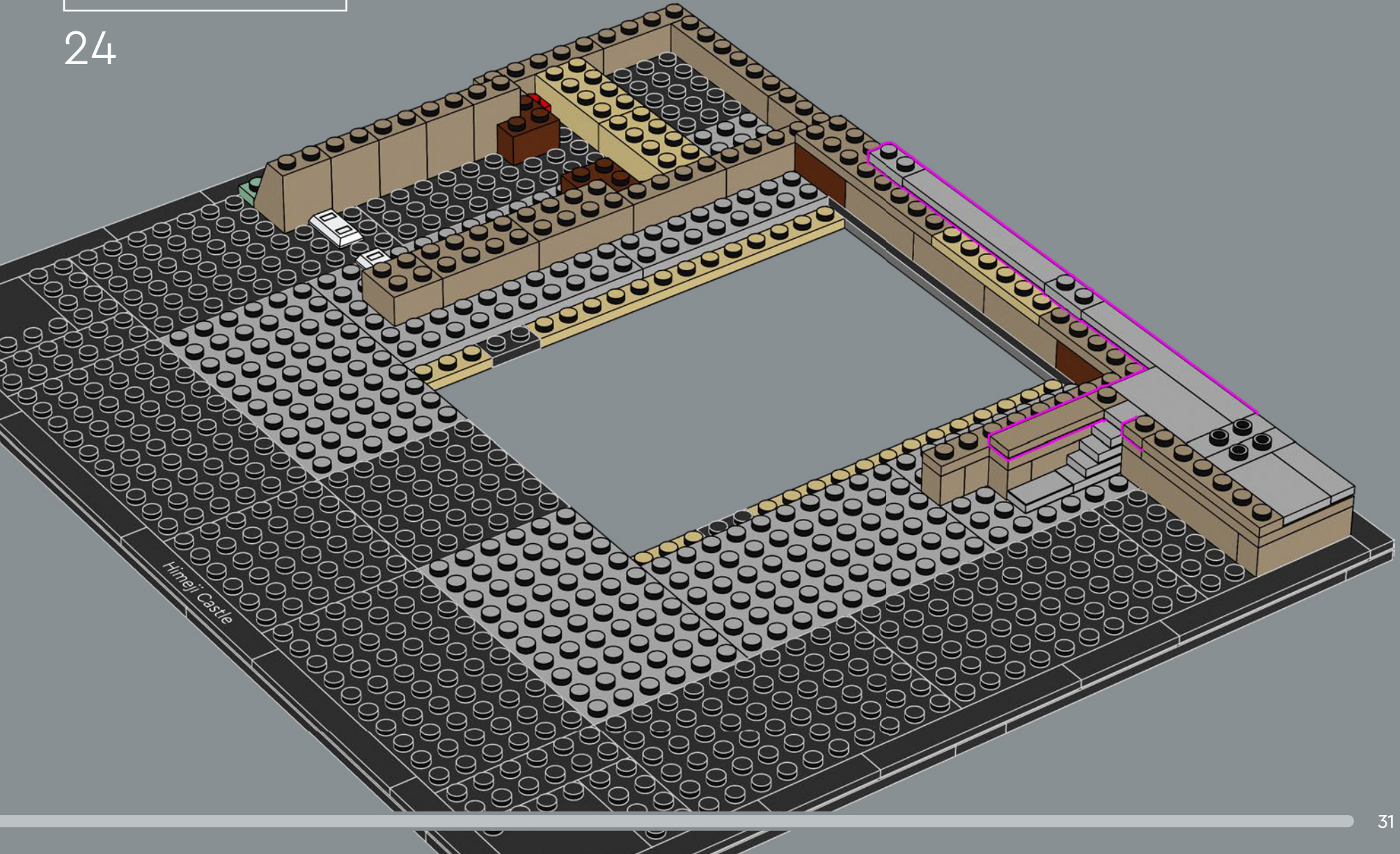



1x  4x  1x 

25

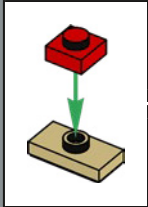
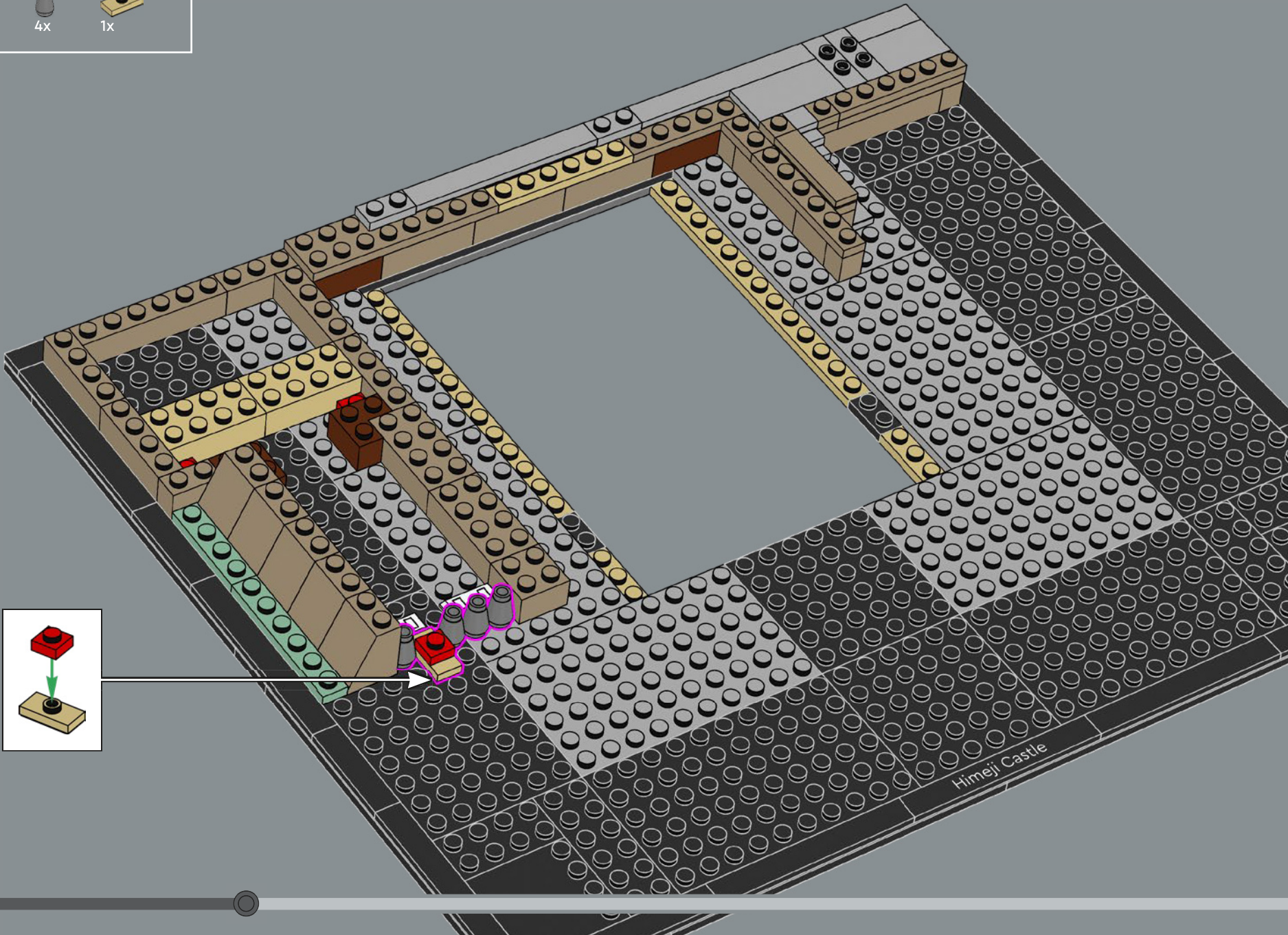

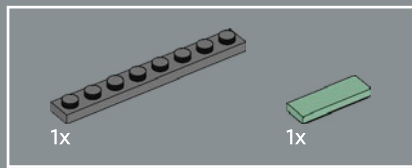

26

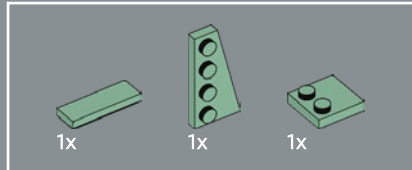
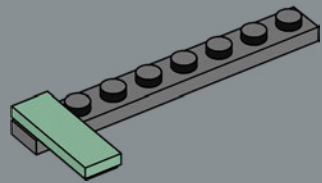

27

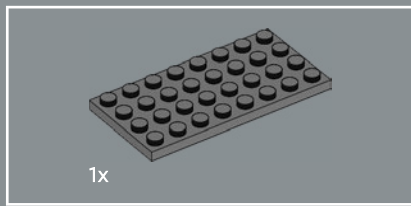
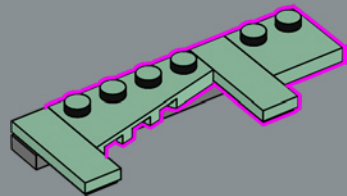

28

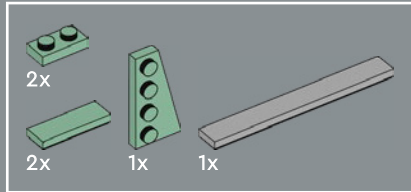
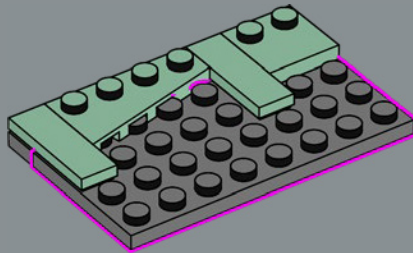

29

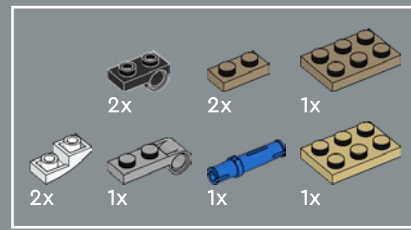
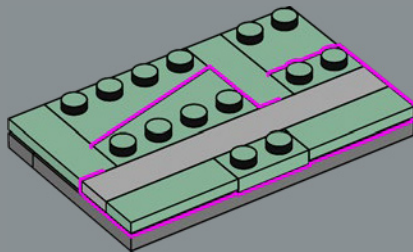

30

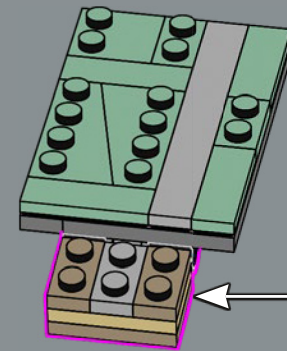
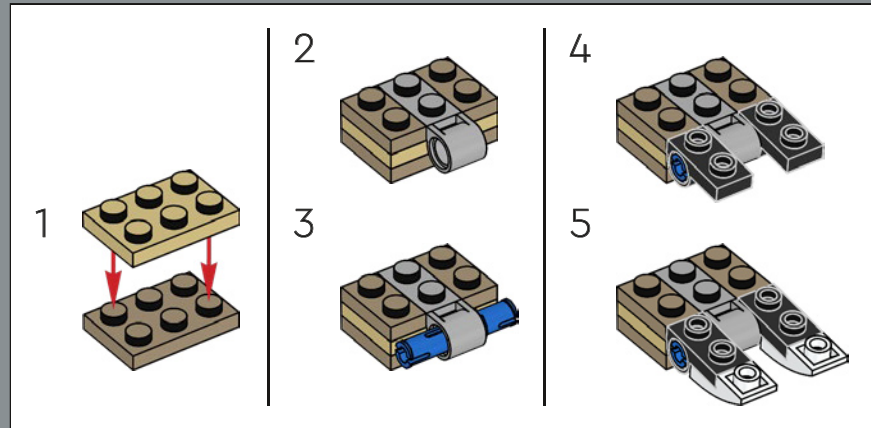



31

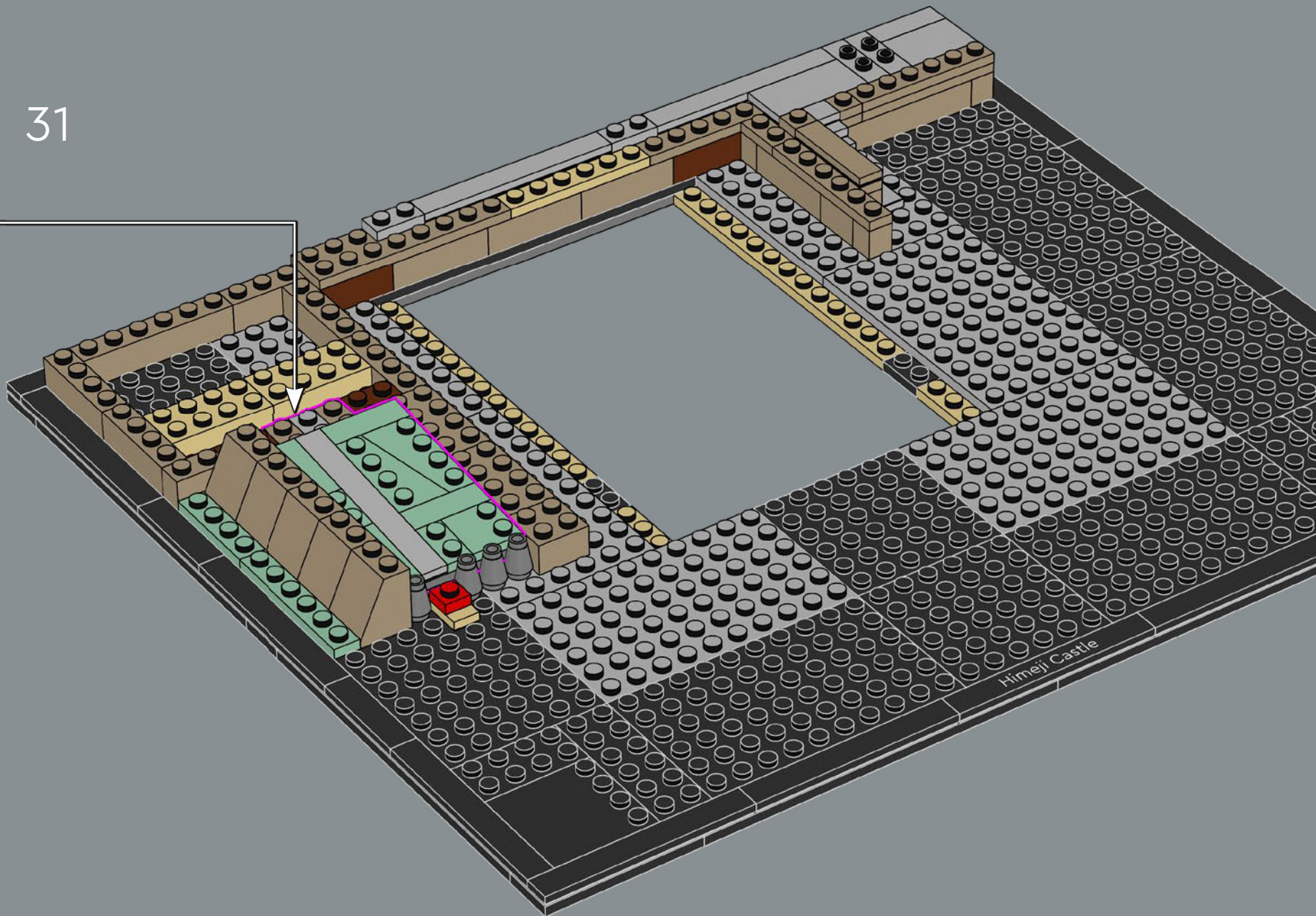



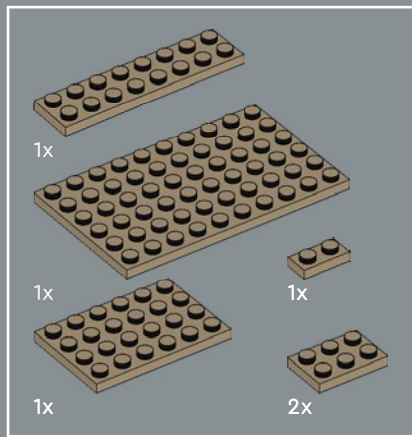

32

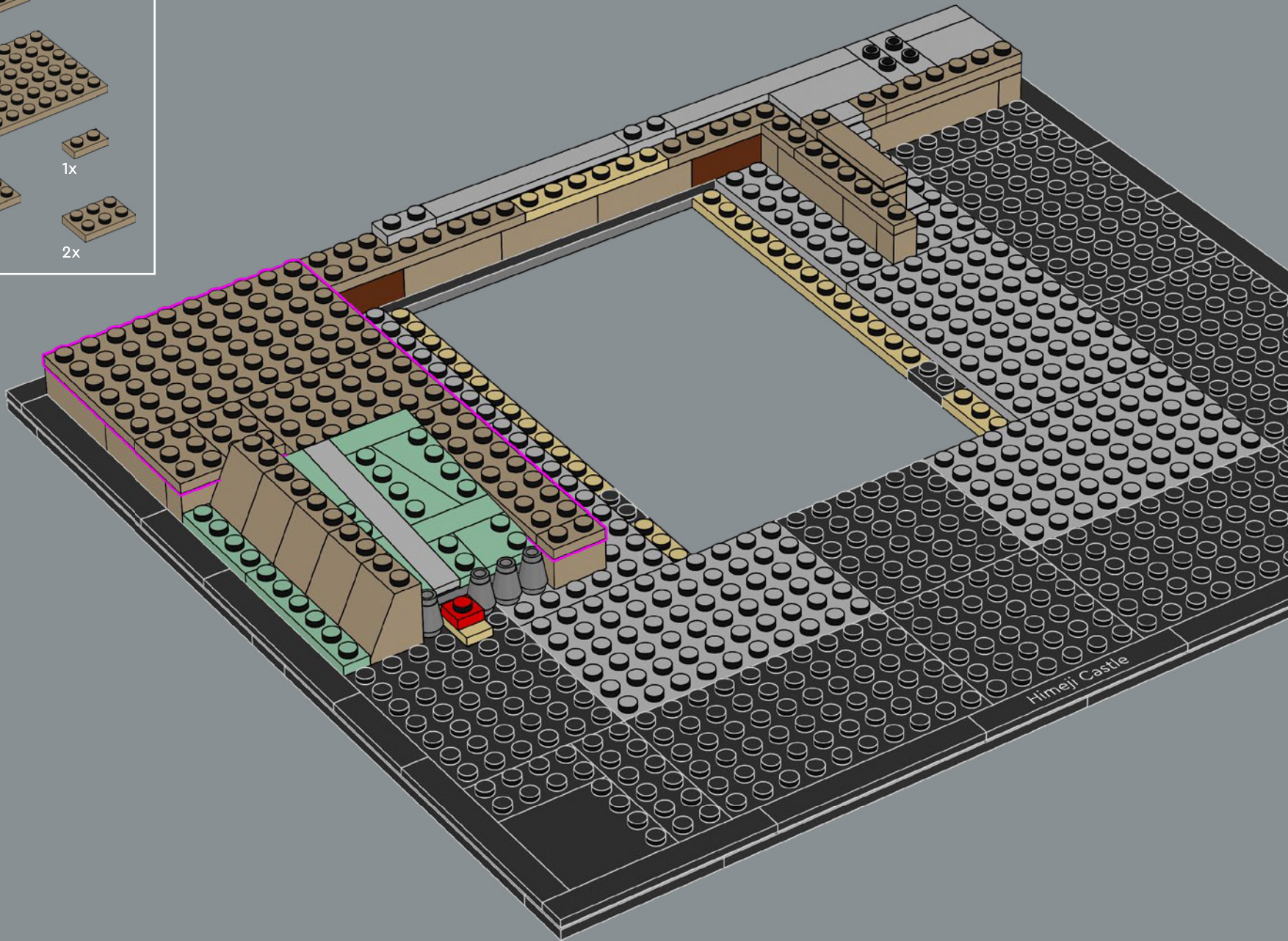

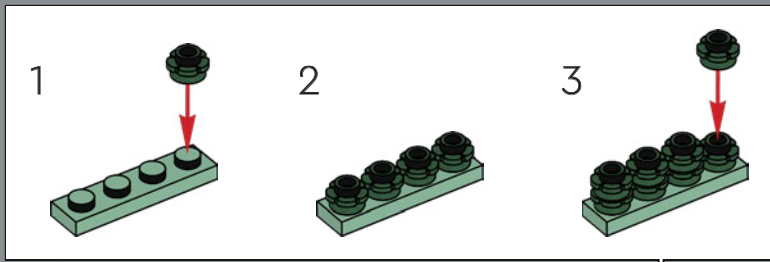
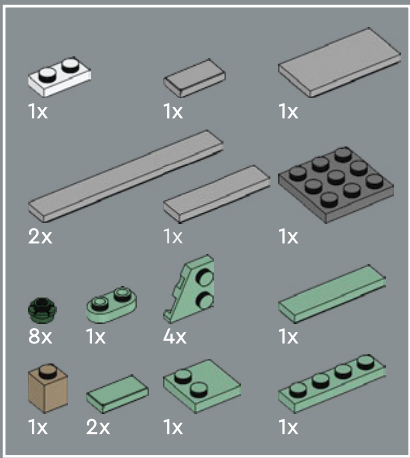

33

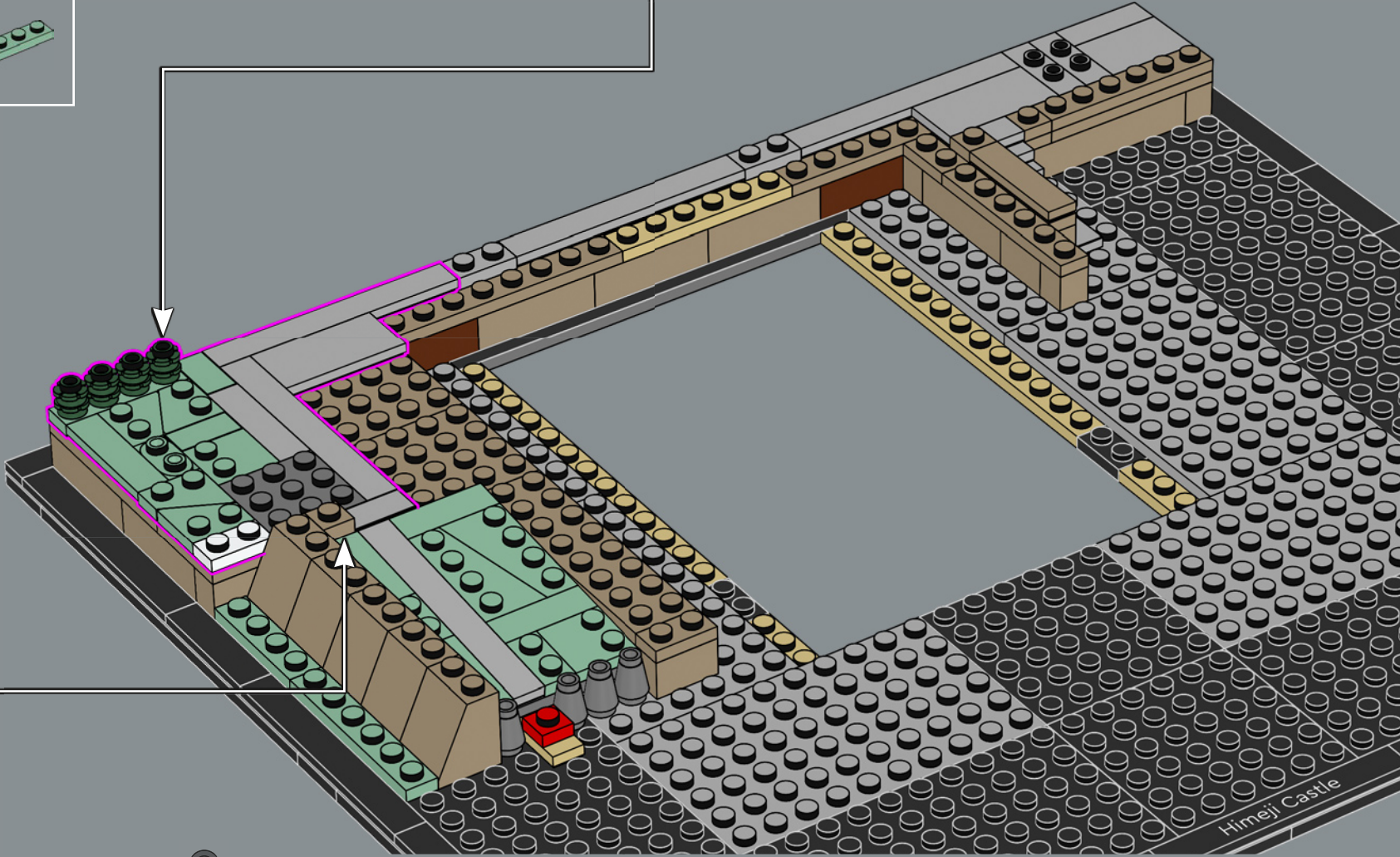

Himeiji Castle



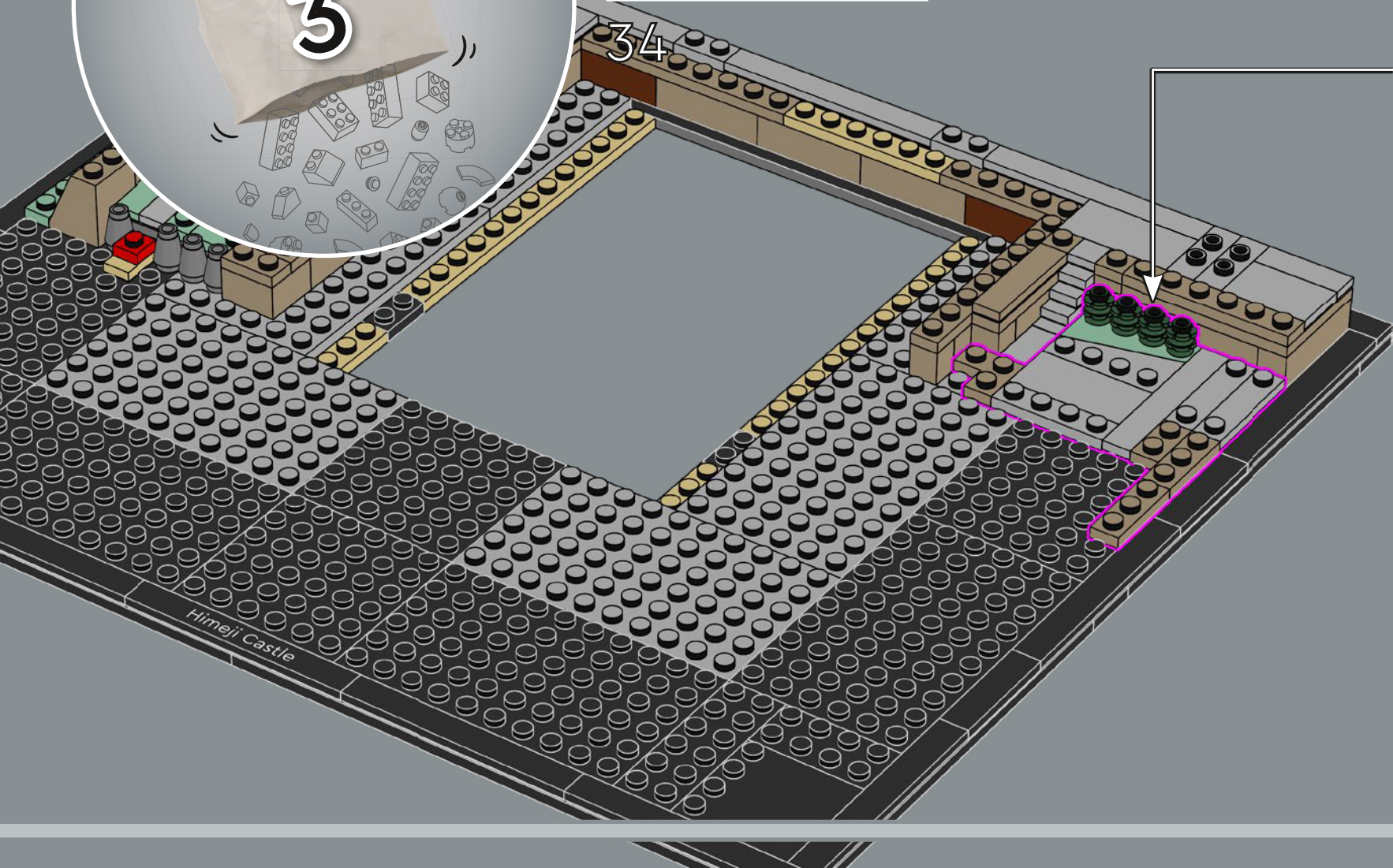
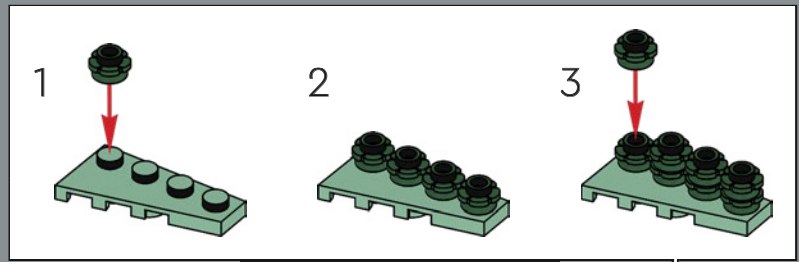
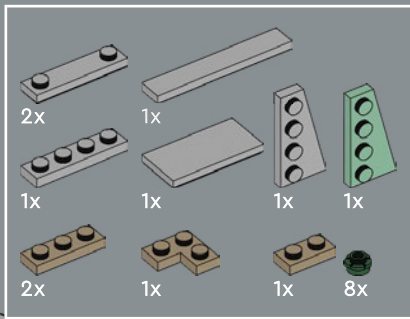



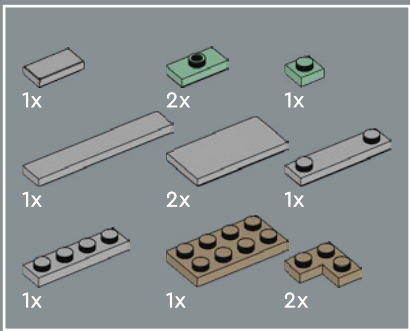

35

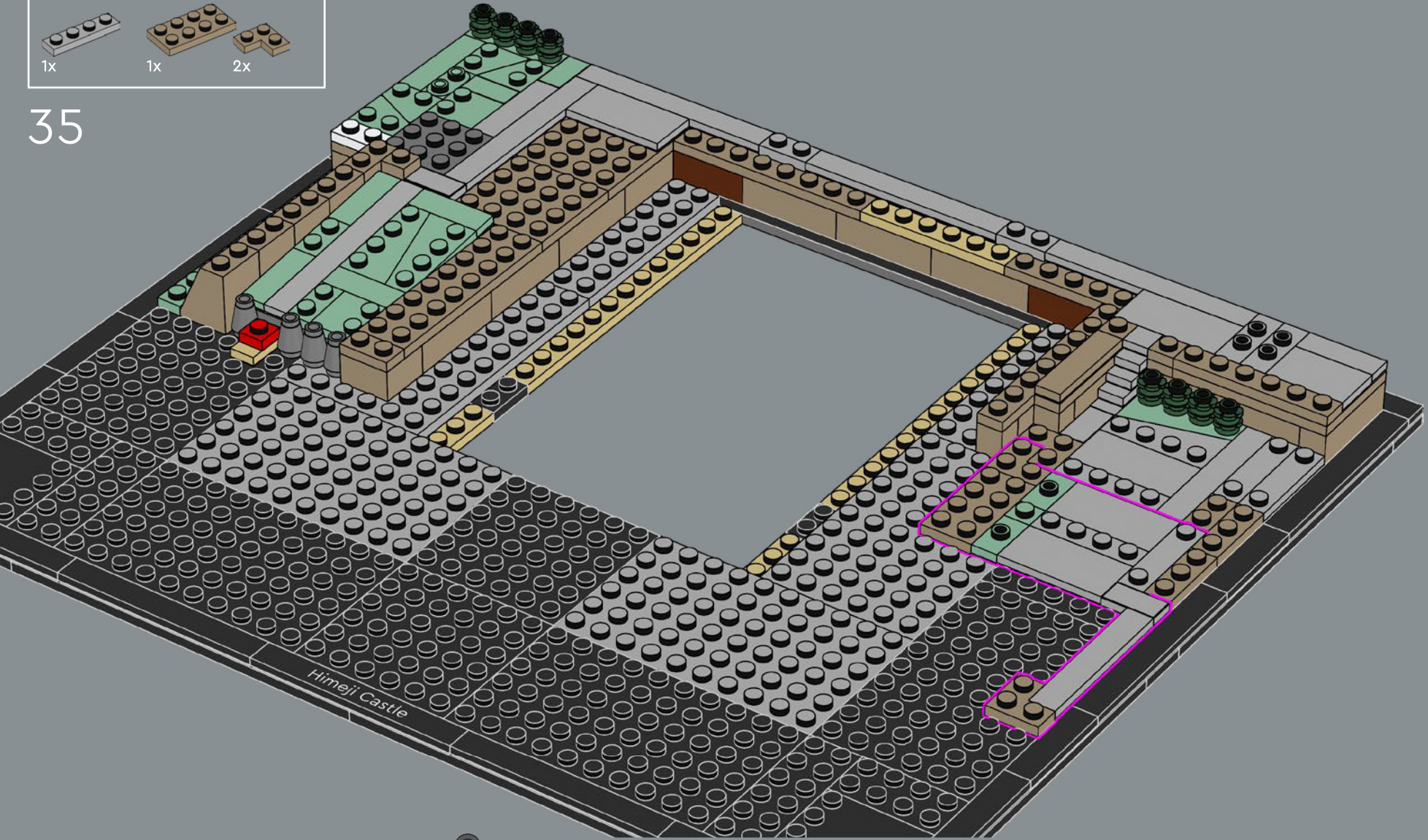



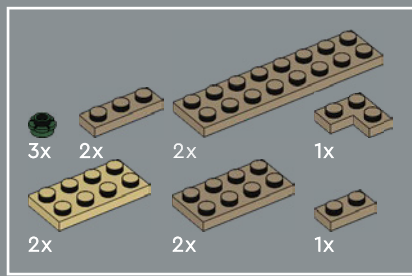

36

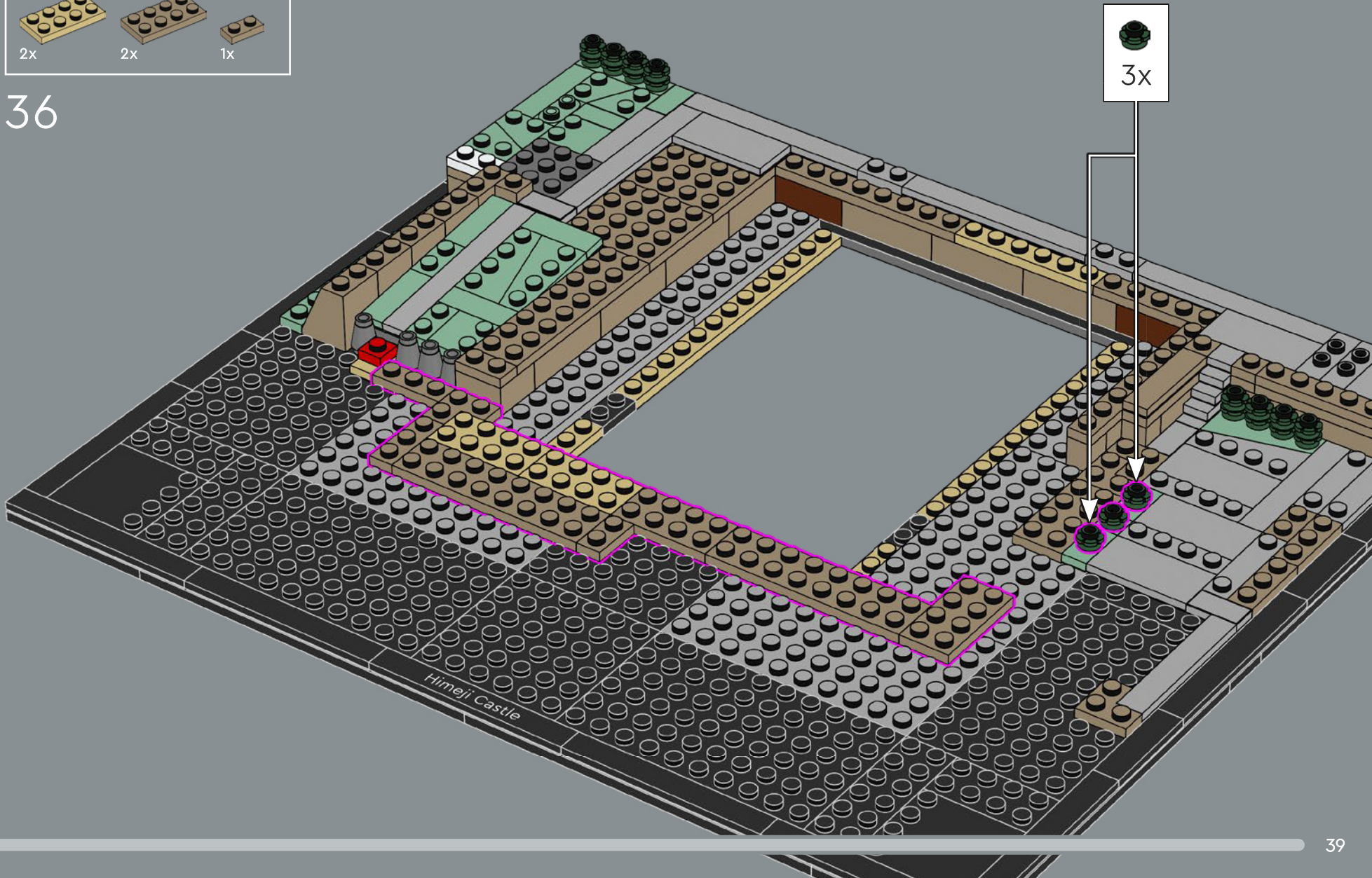



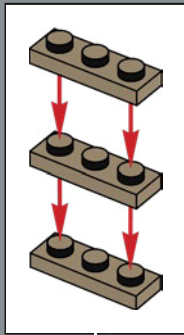
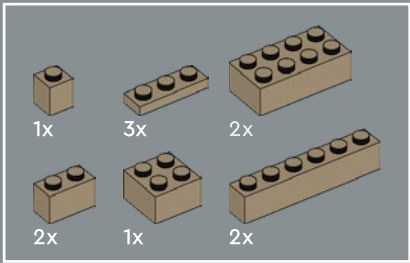

37

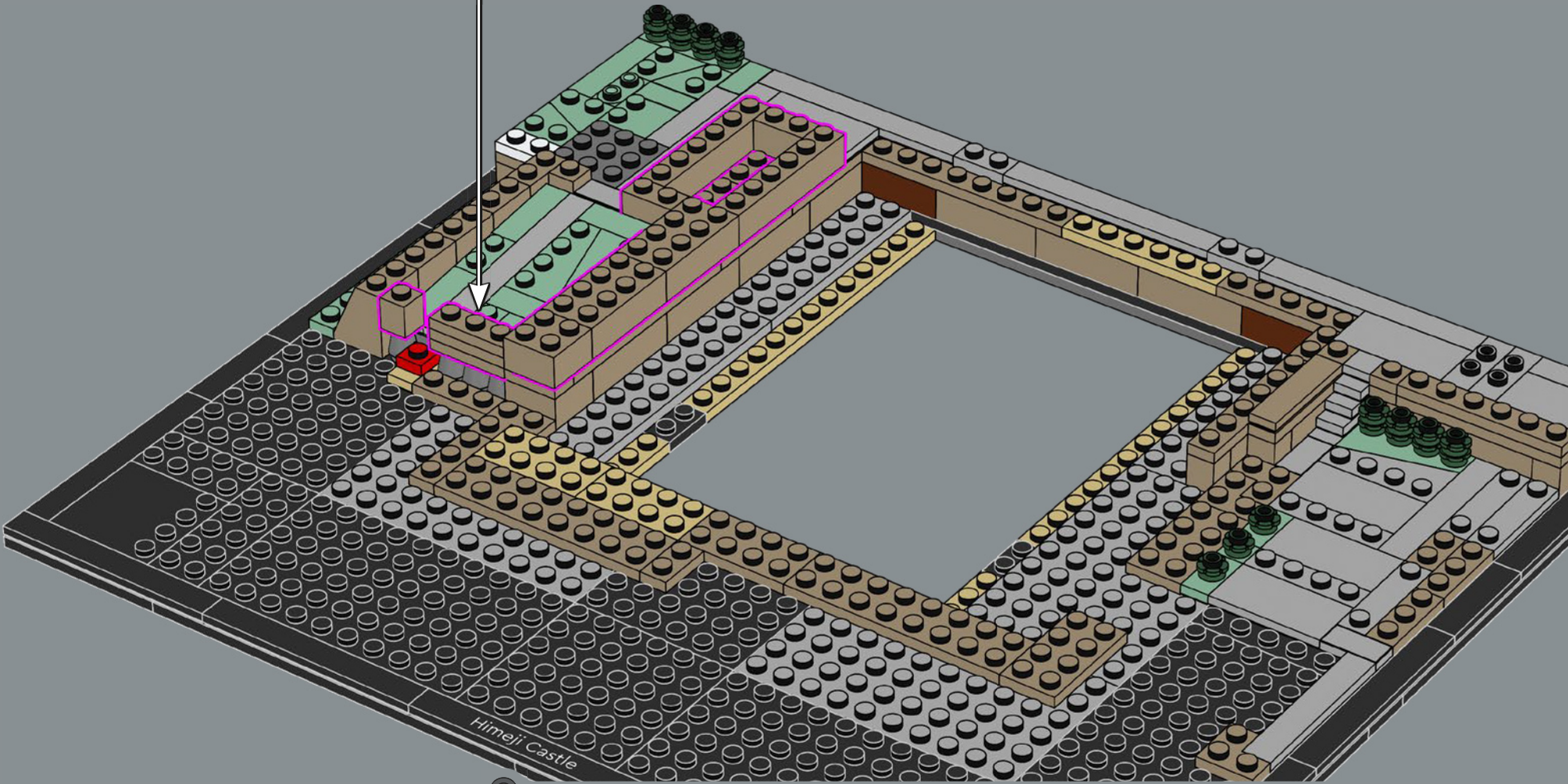



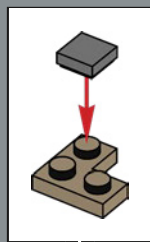
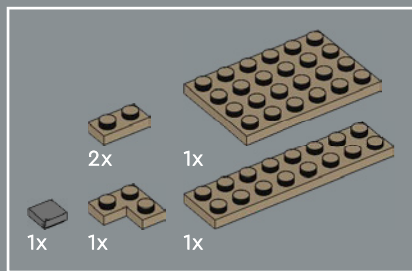

38

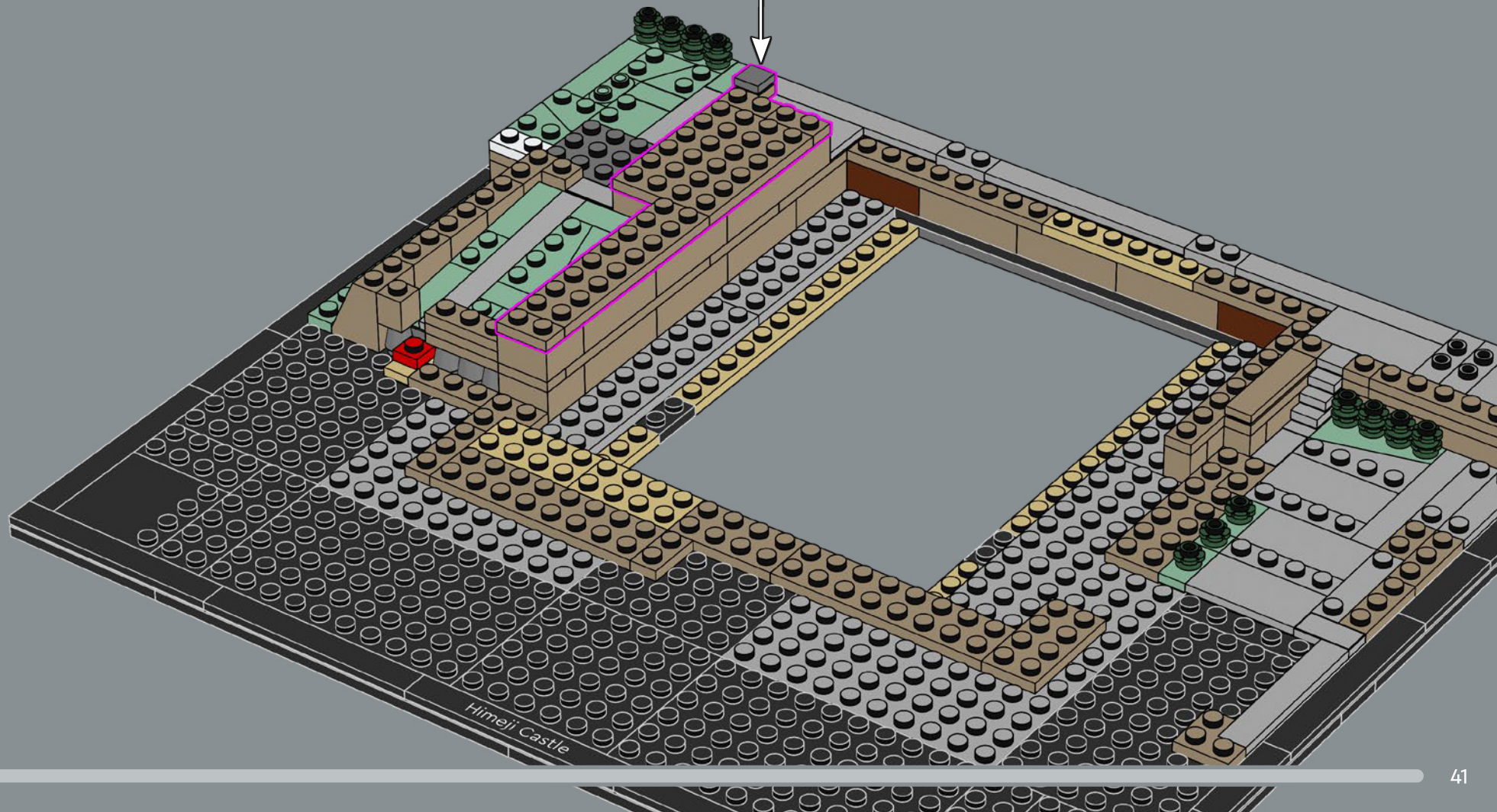



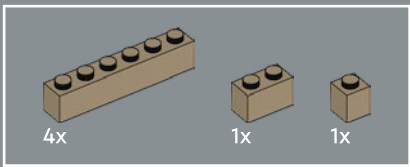

39

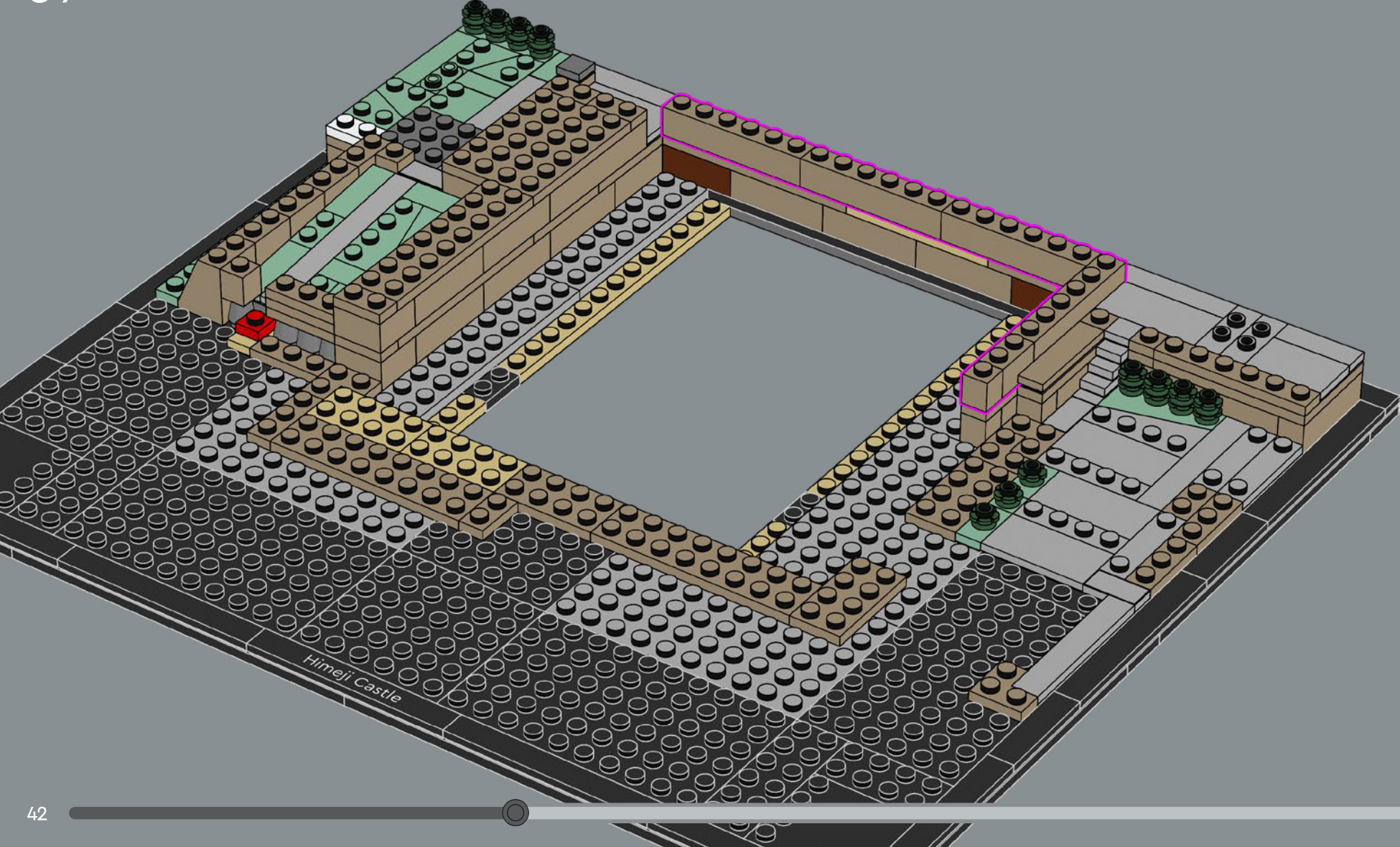



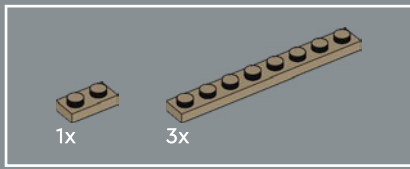

40

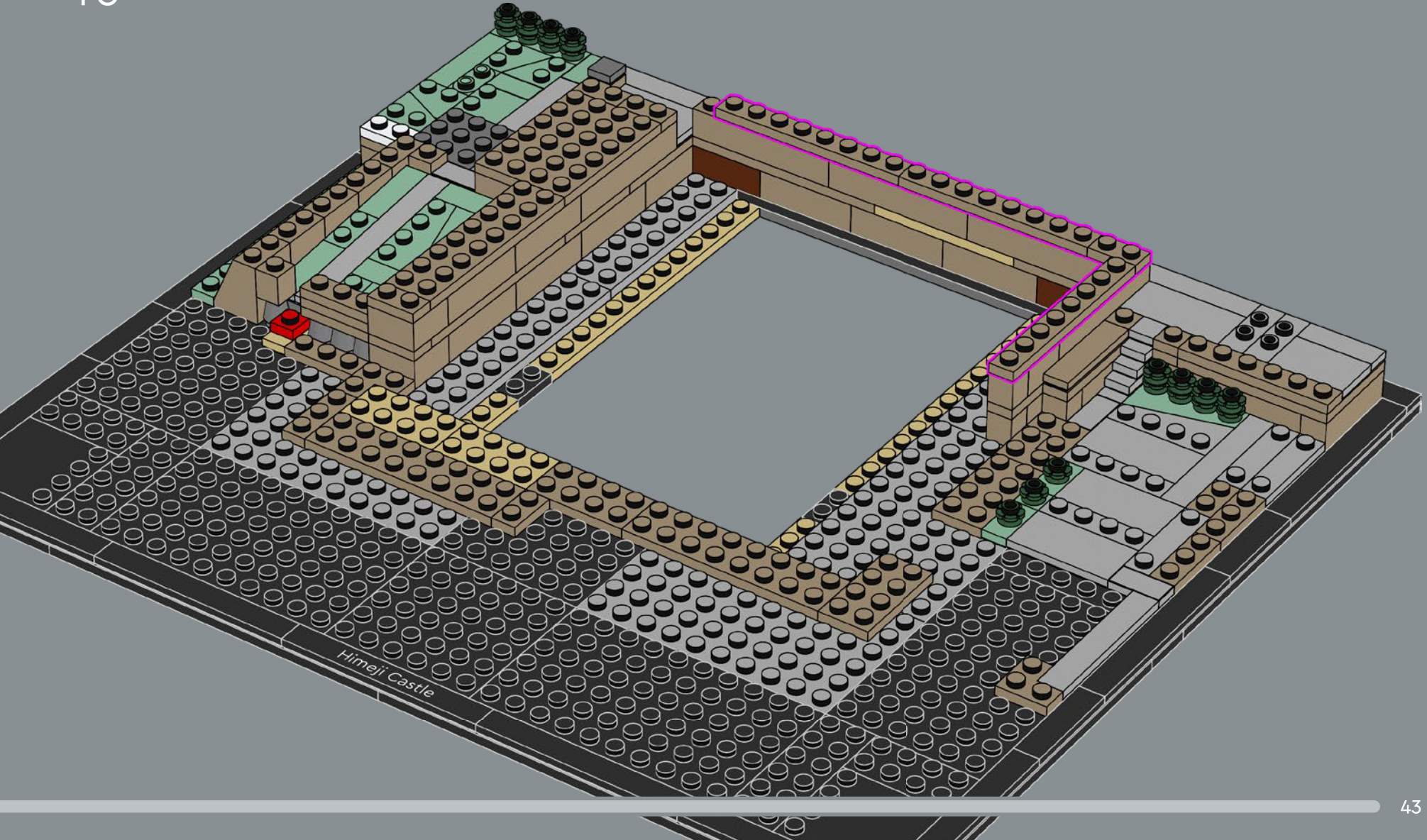

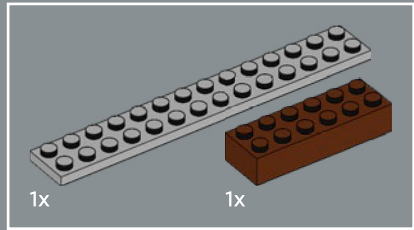
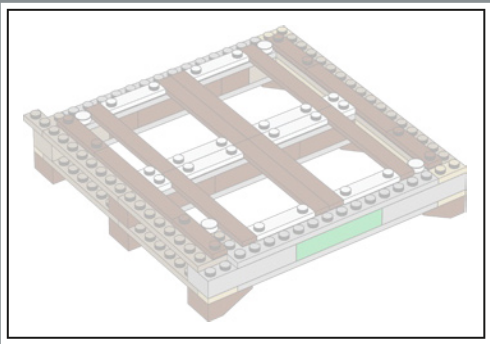

41

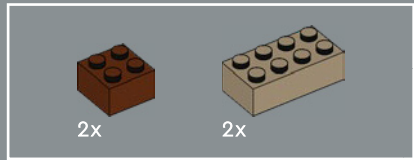
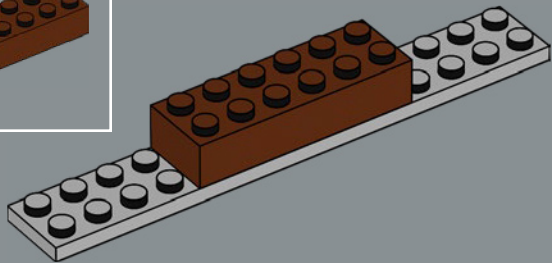

42

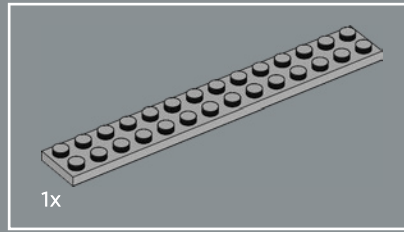
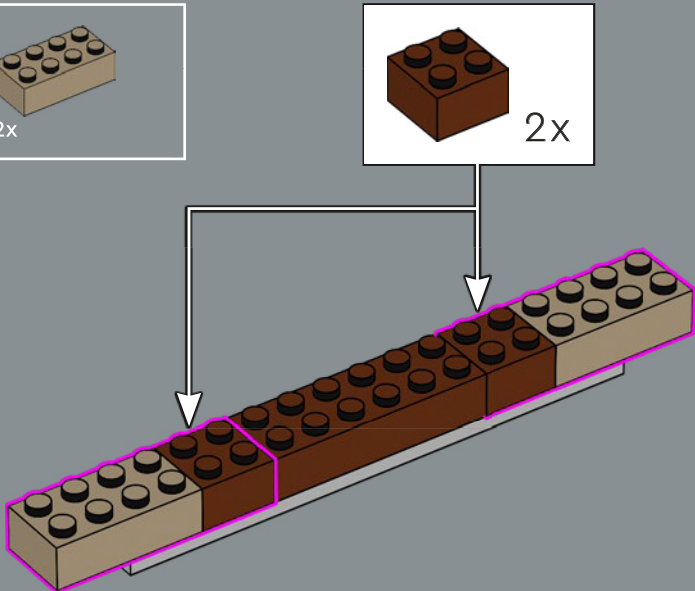

43

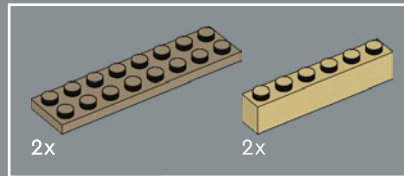
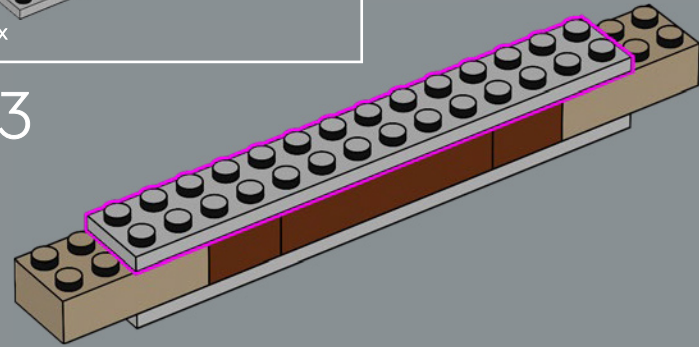

44

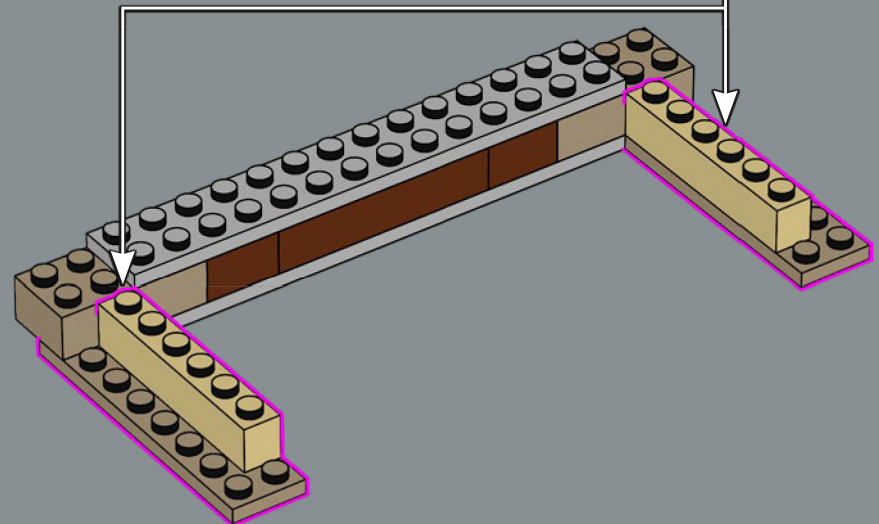
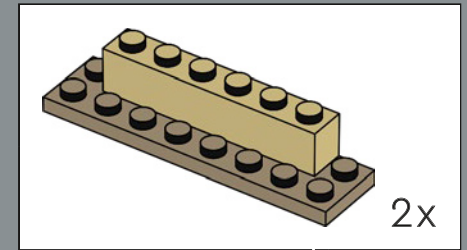



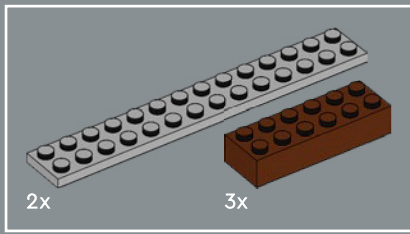

45

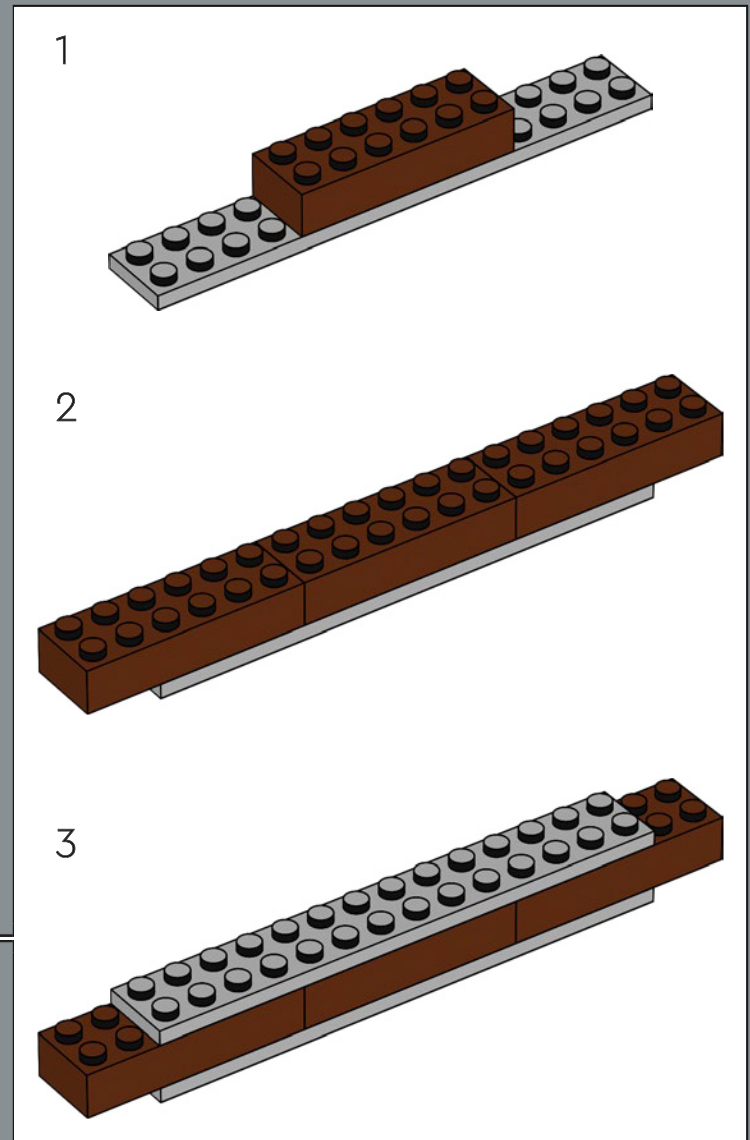
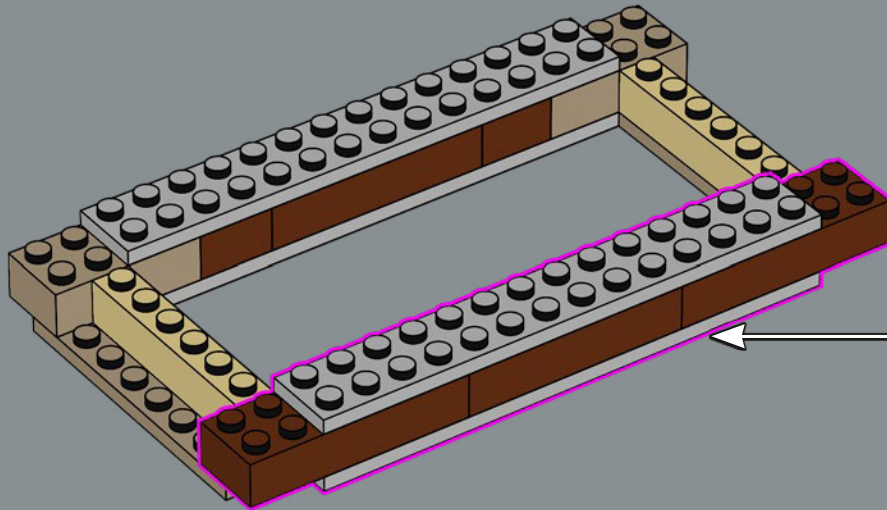

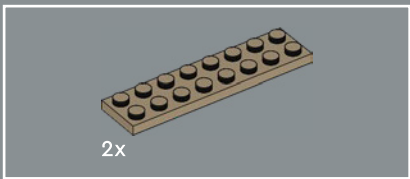

46

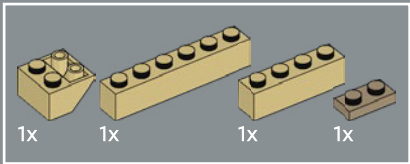
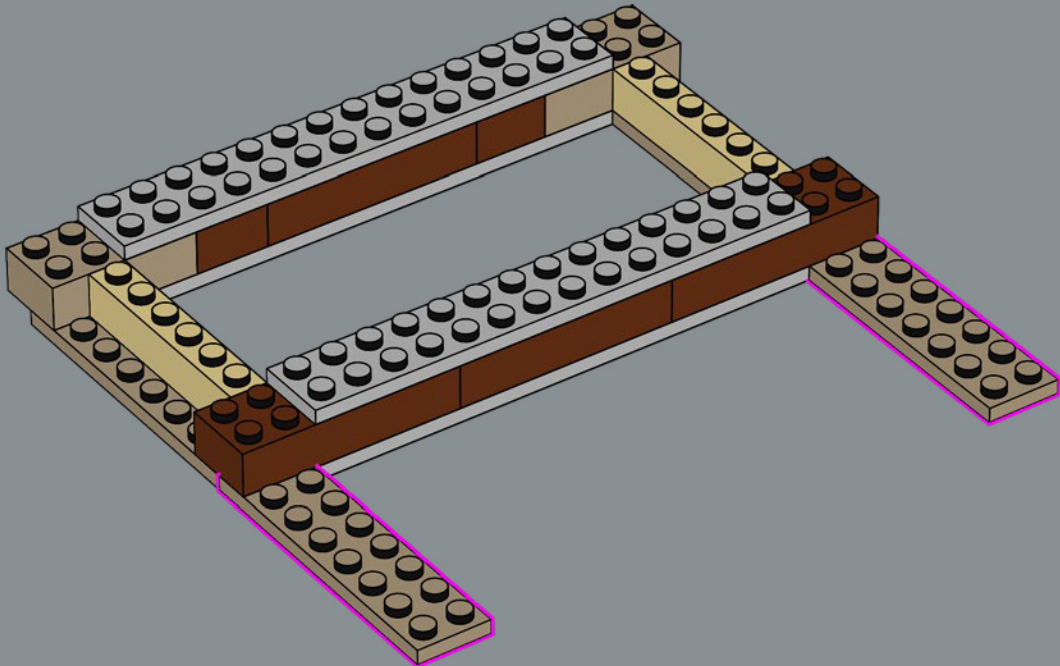

47

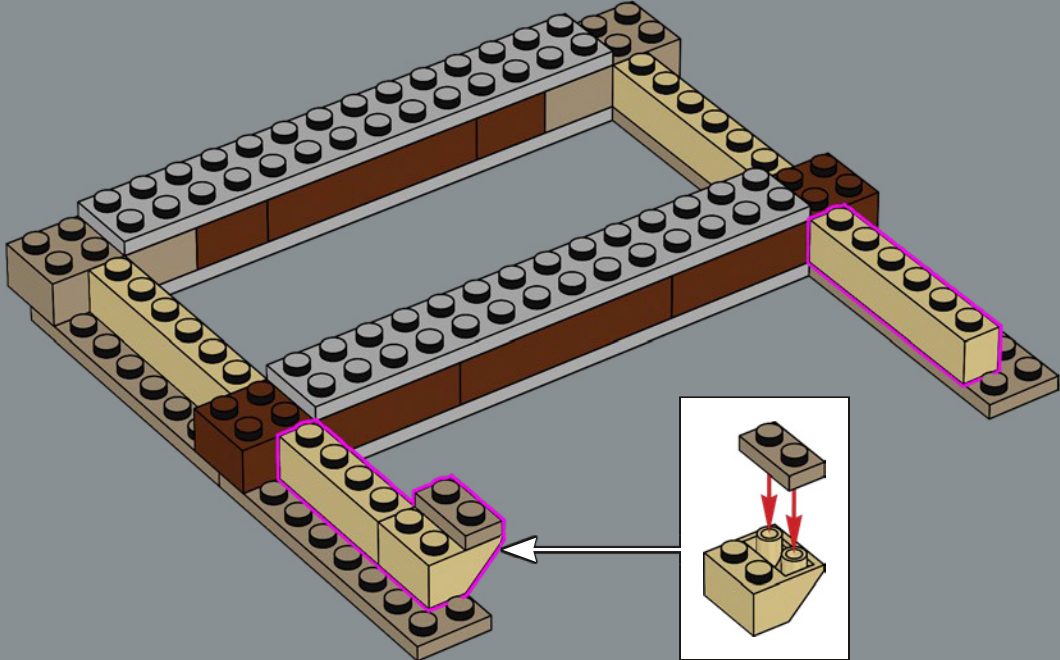



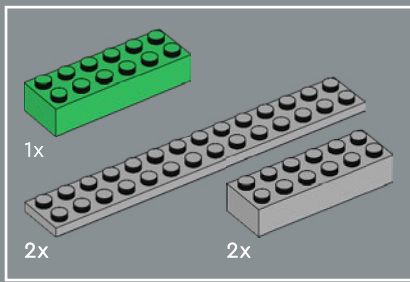

48

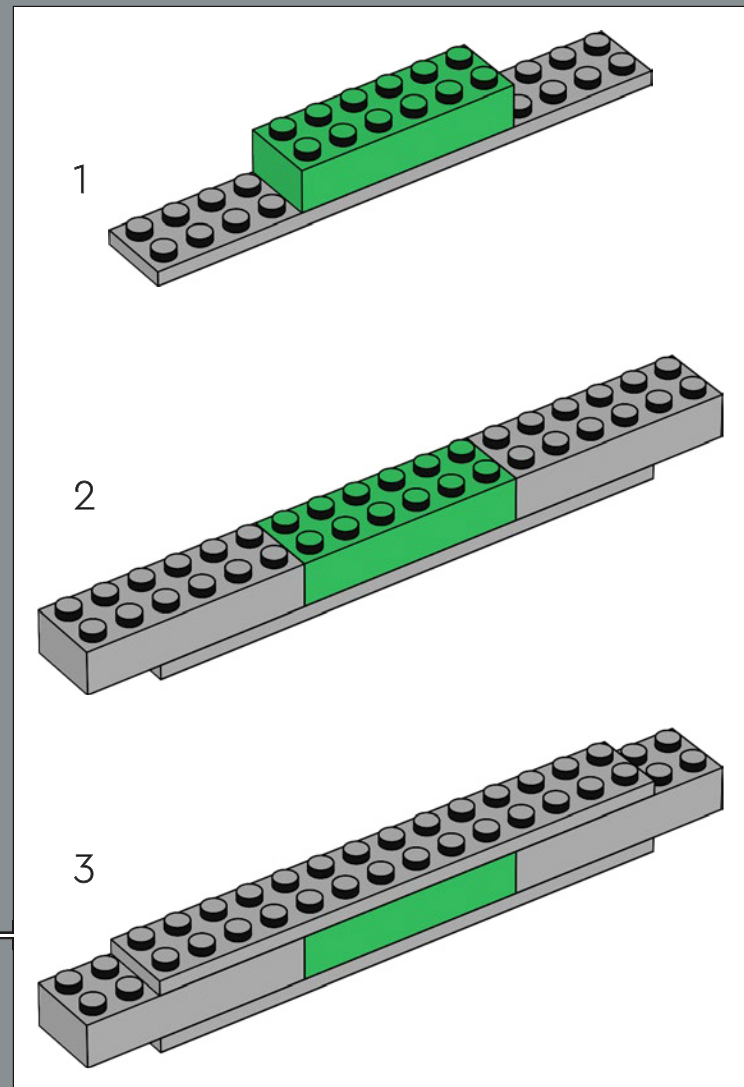
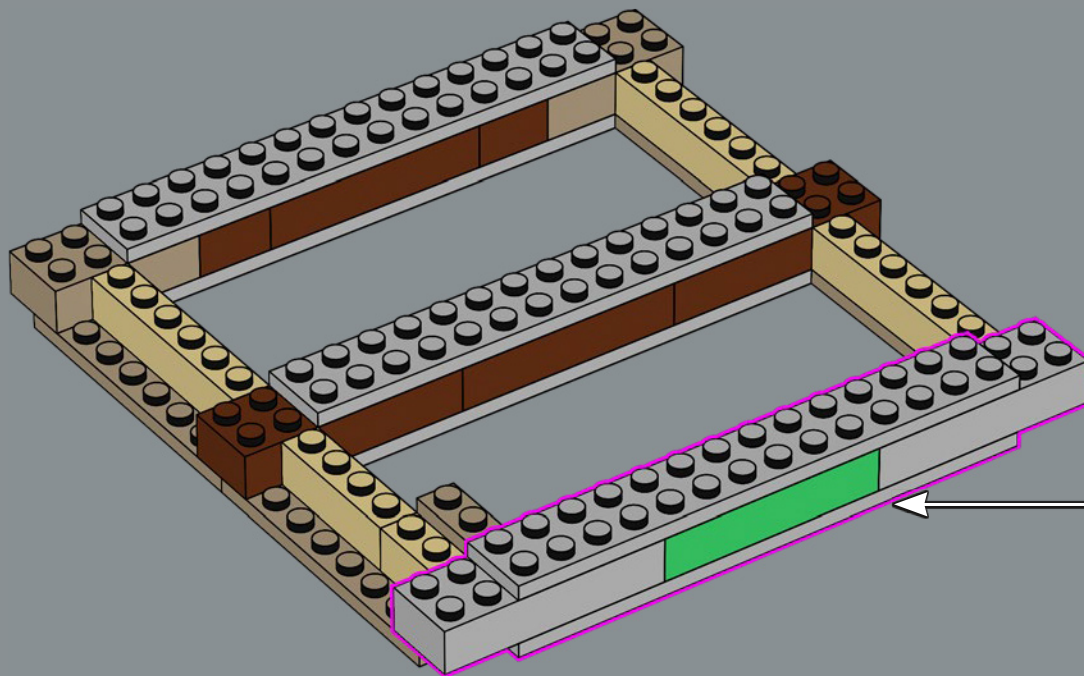

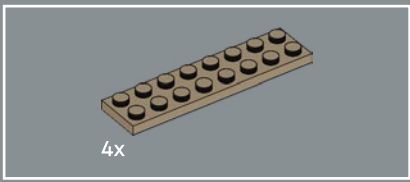

49

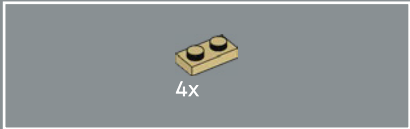
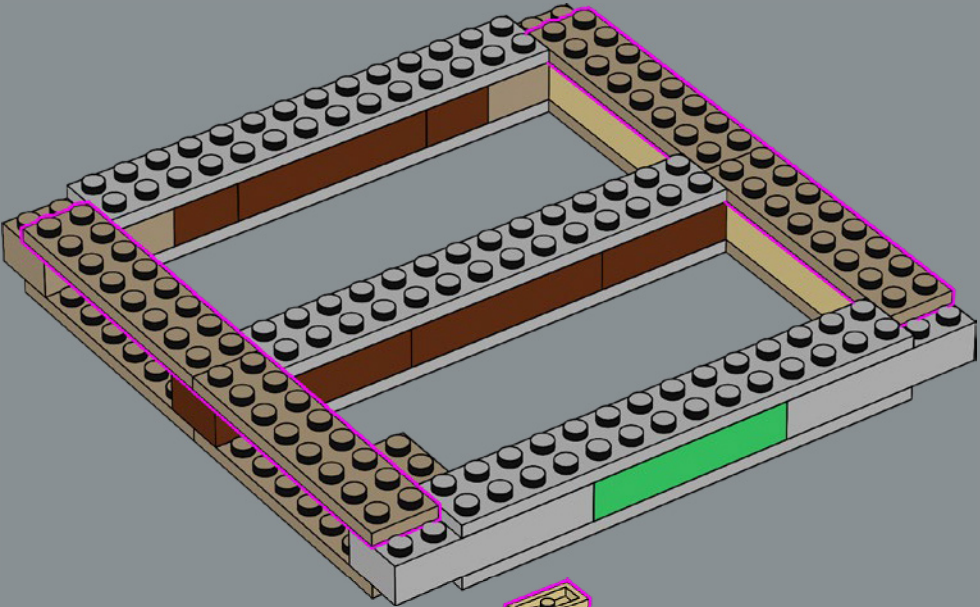

50

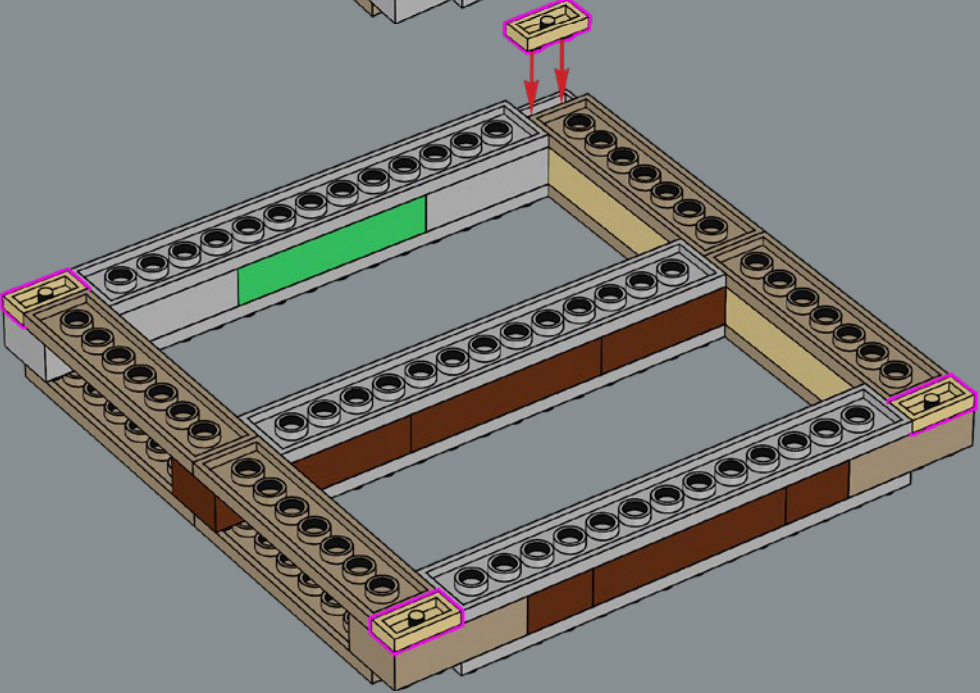





51

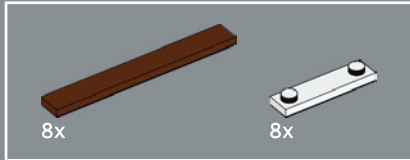
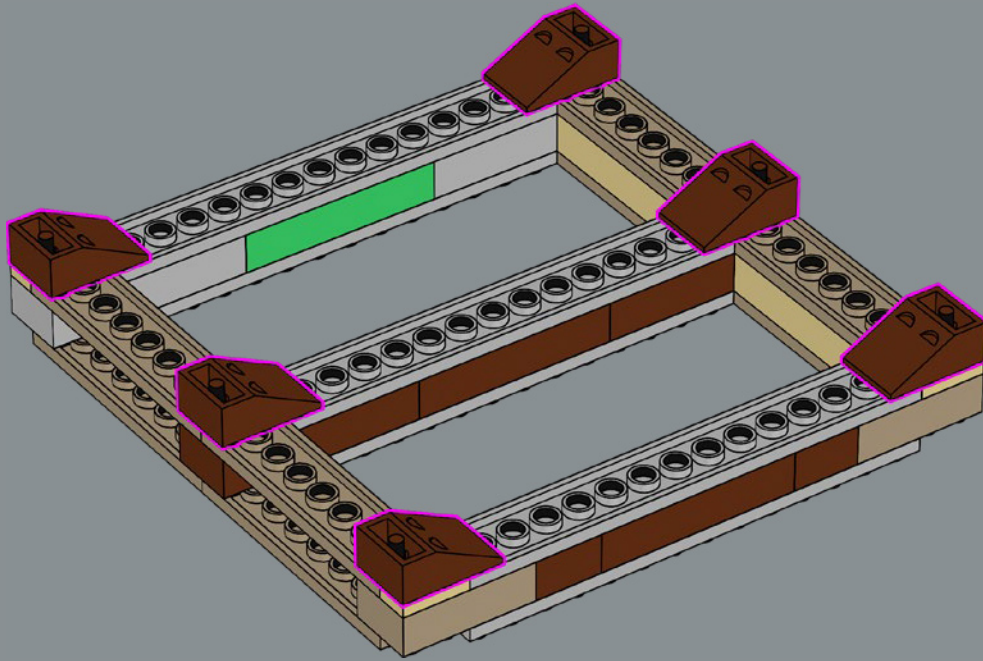

52

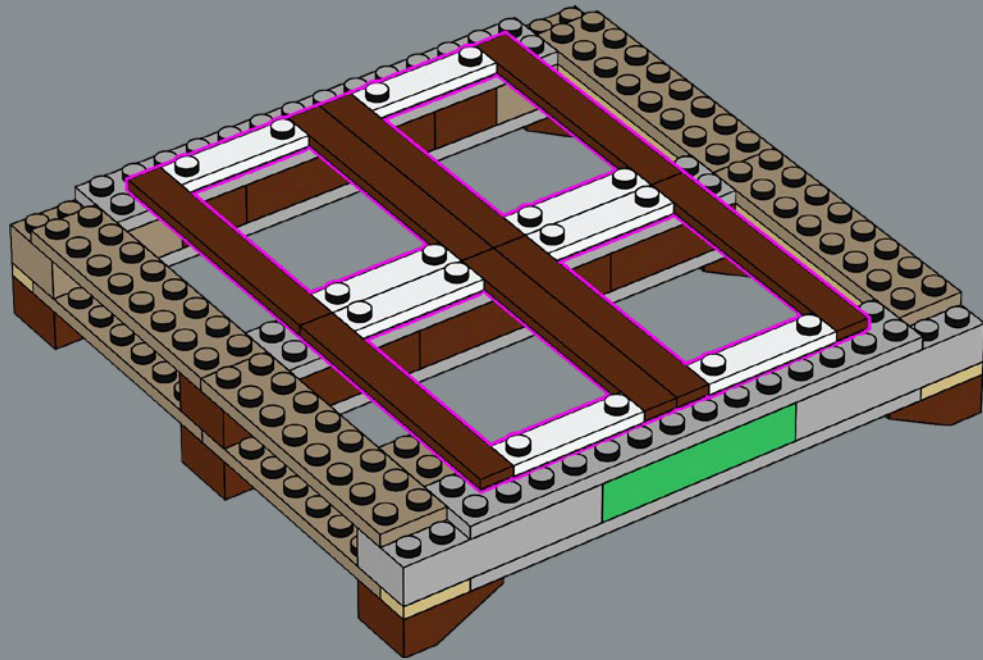

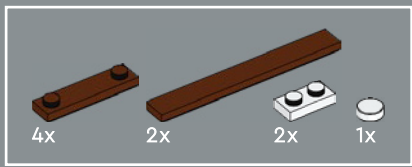

53

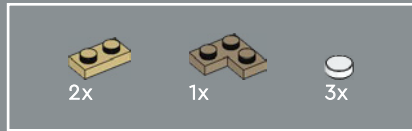
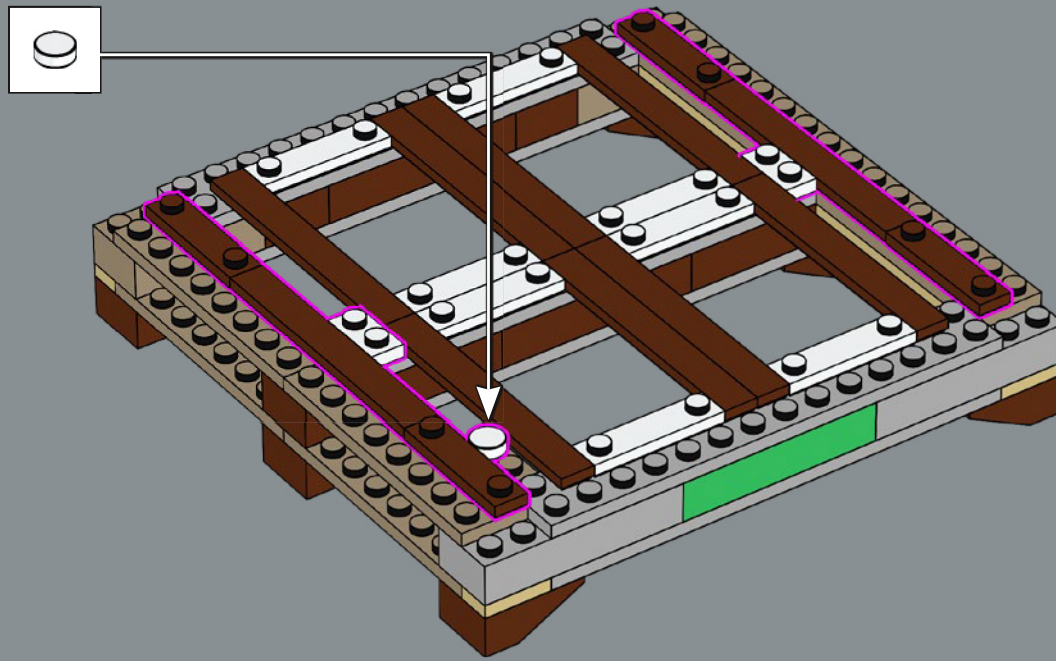

54

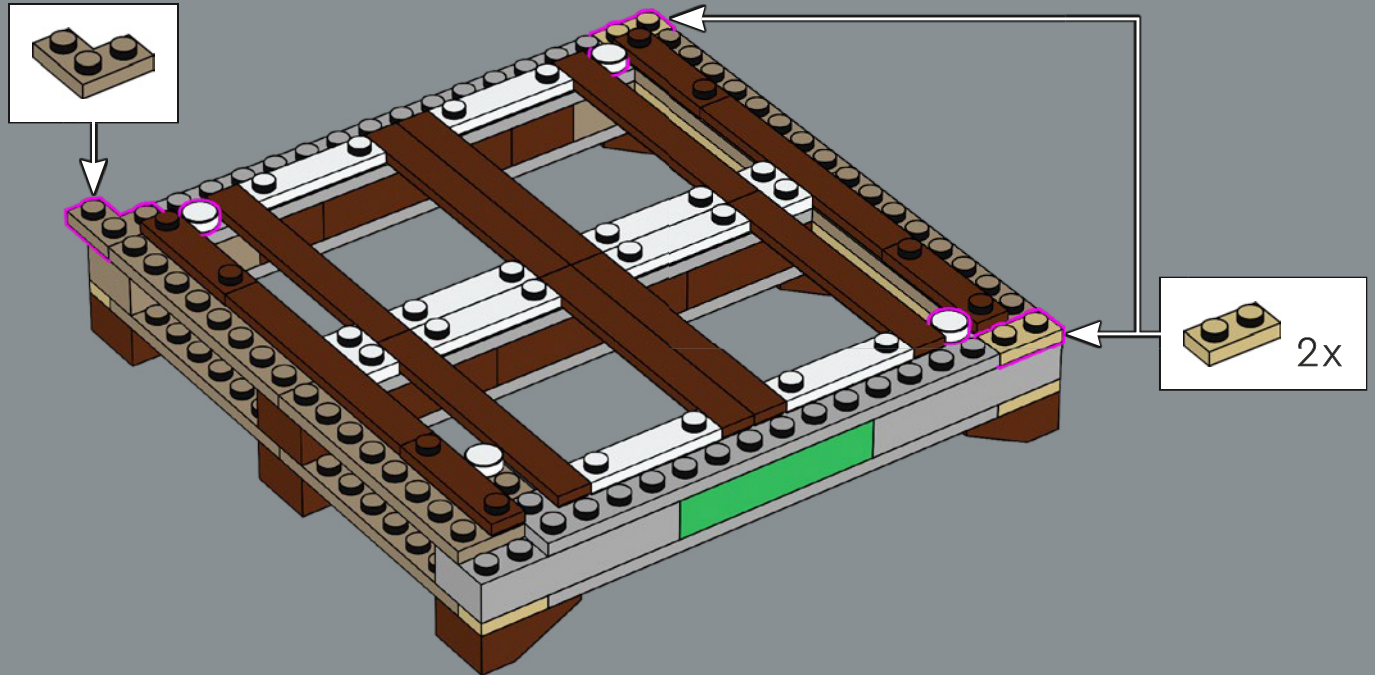



55

In dem Modell wird die Burg von einem Sockel aus LEGO Steinen getragen, der das Braun und Weiß im gesamten Innenbereich der Burg aufgreift.

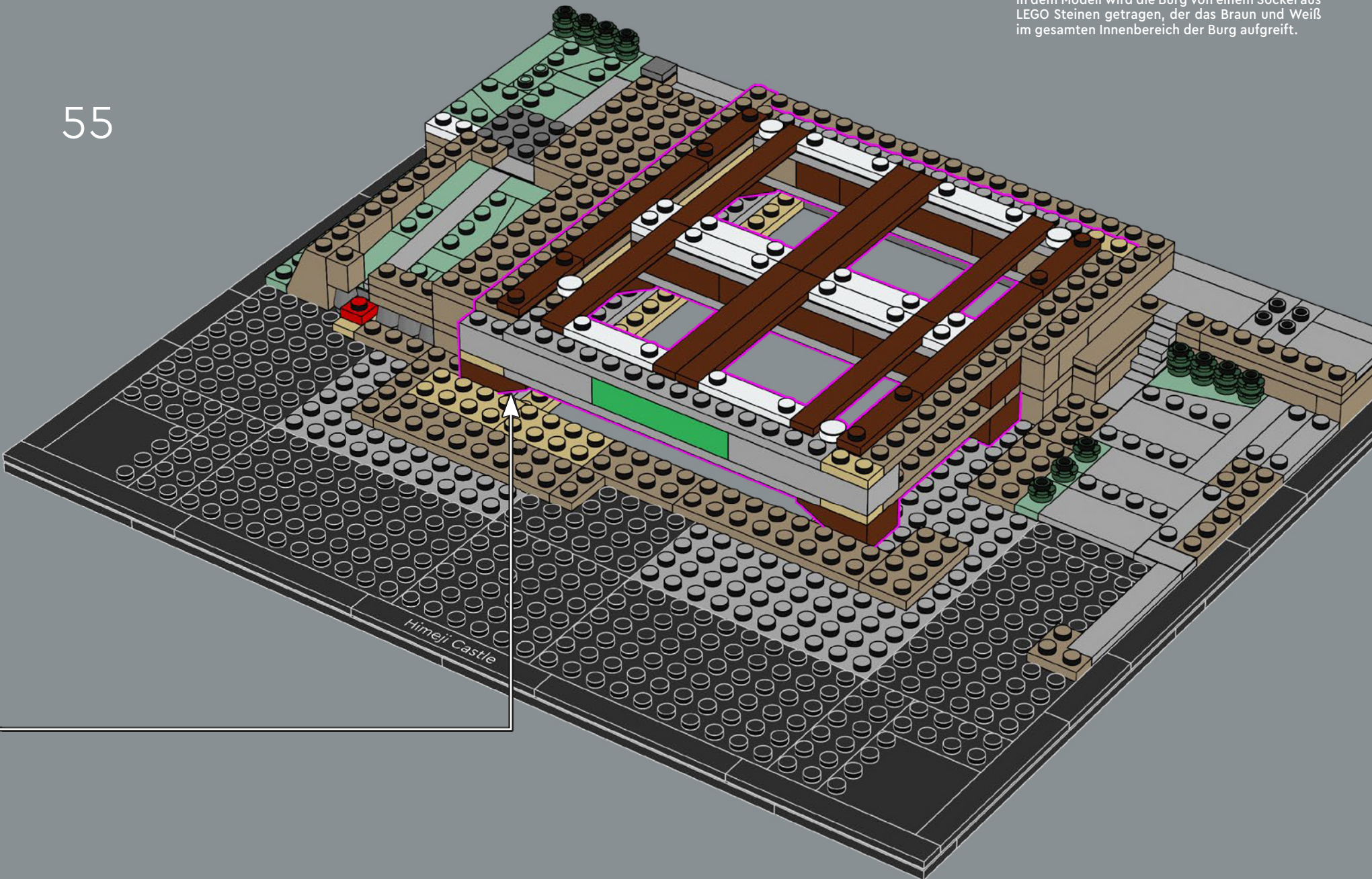



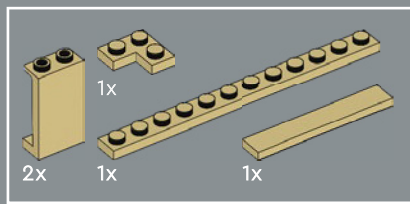

56

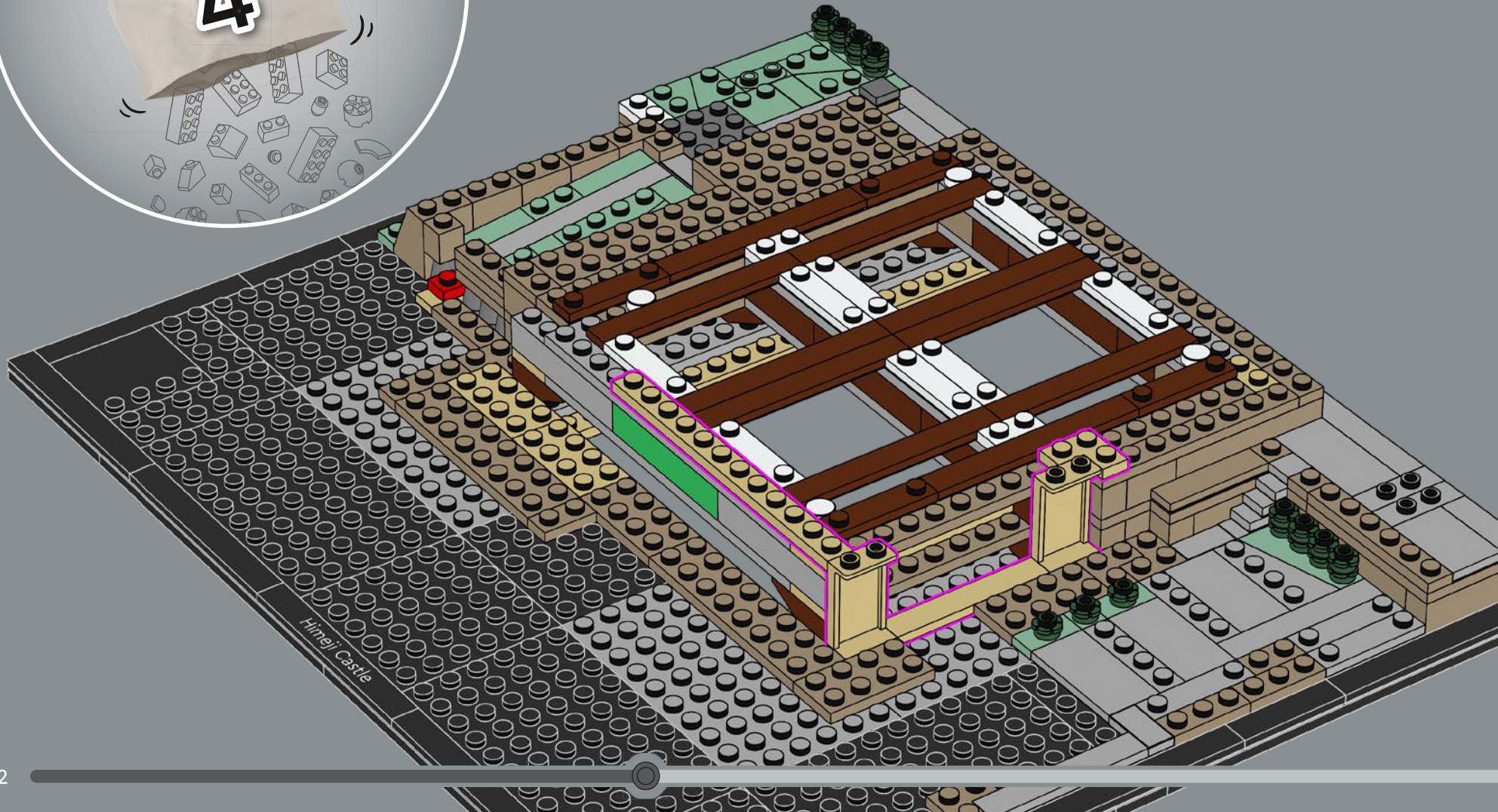



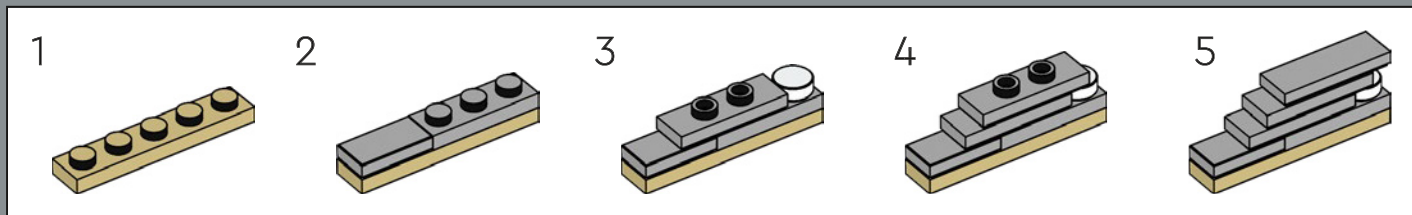
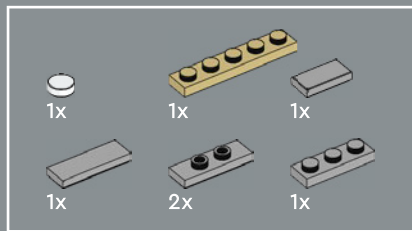

57

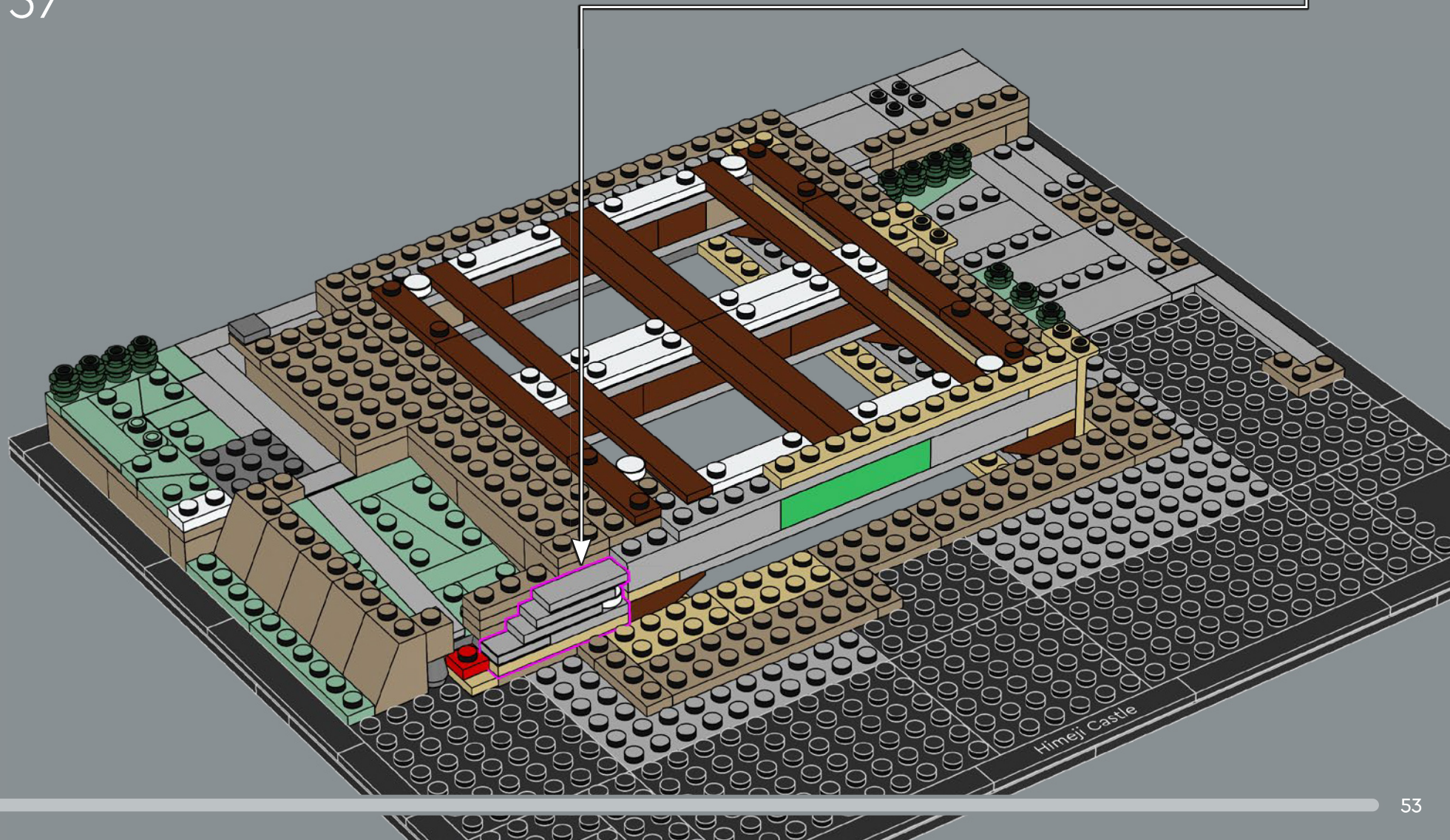



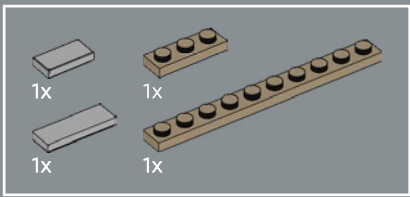

58

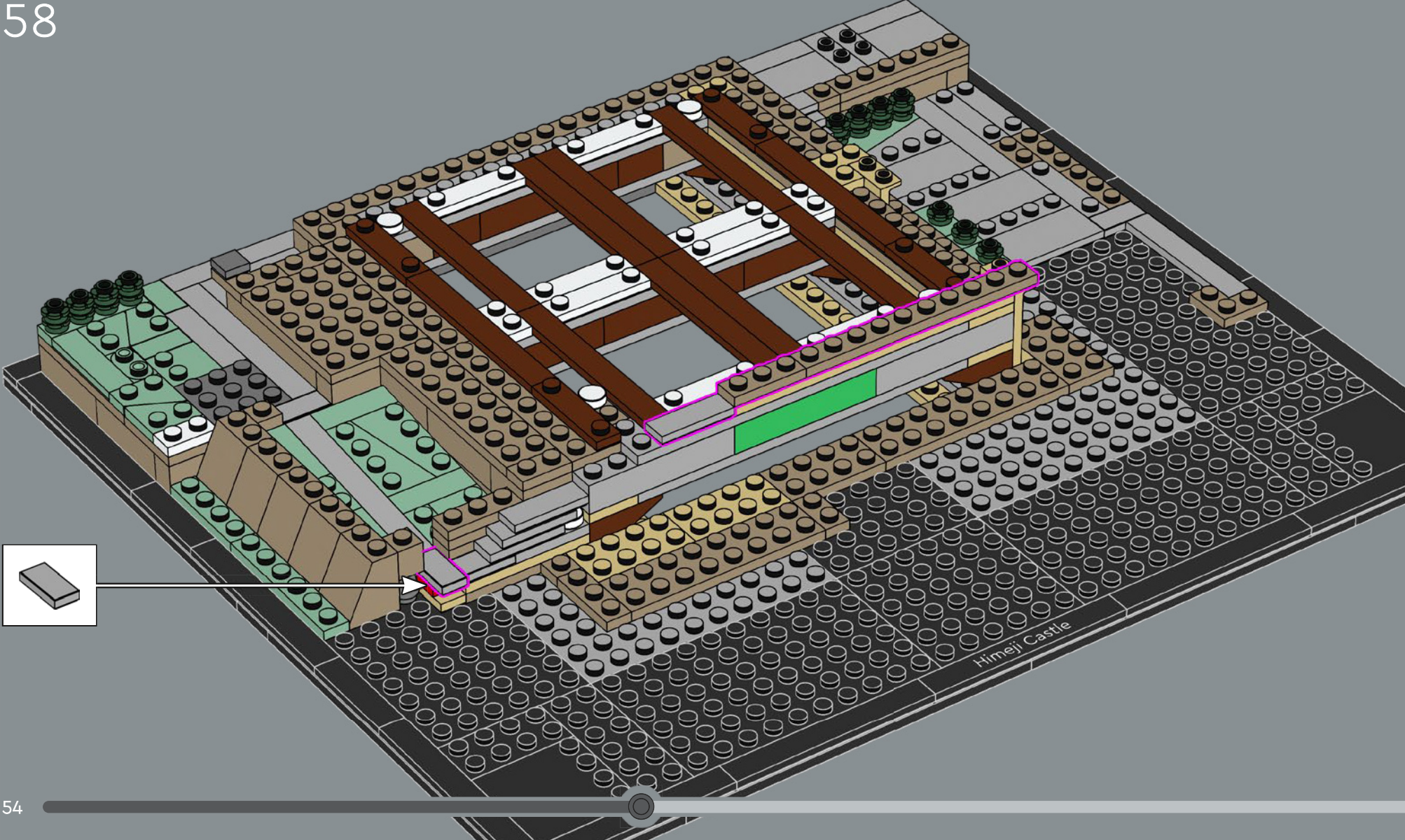



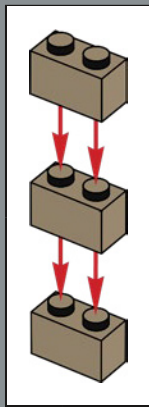
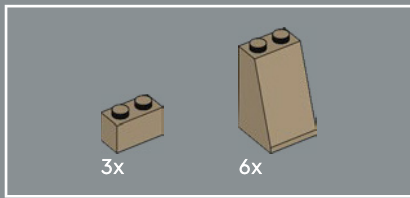

59

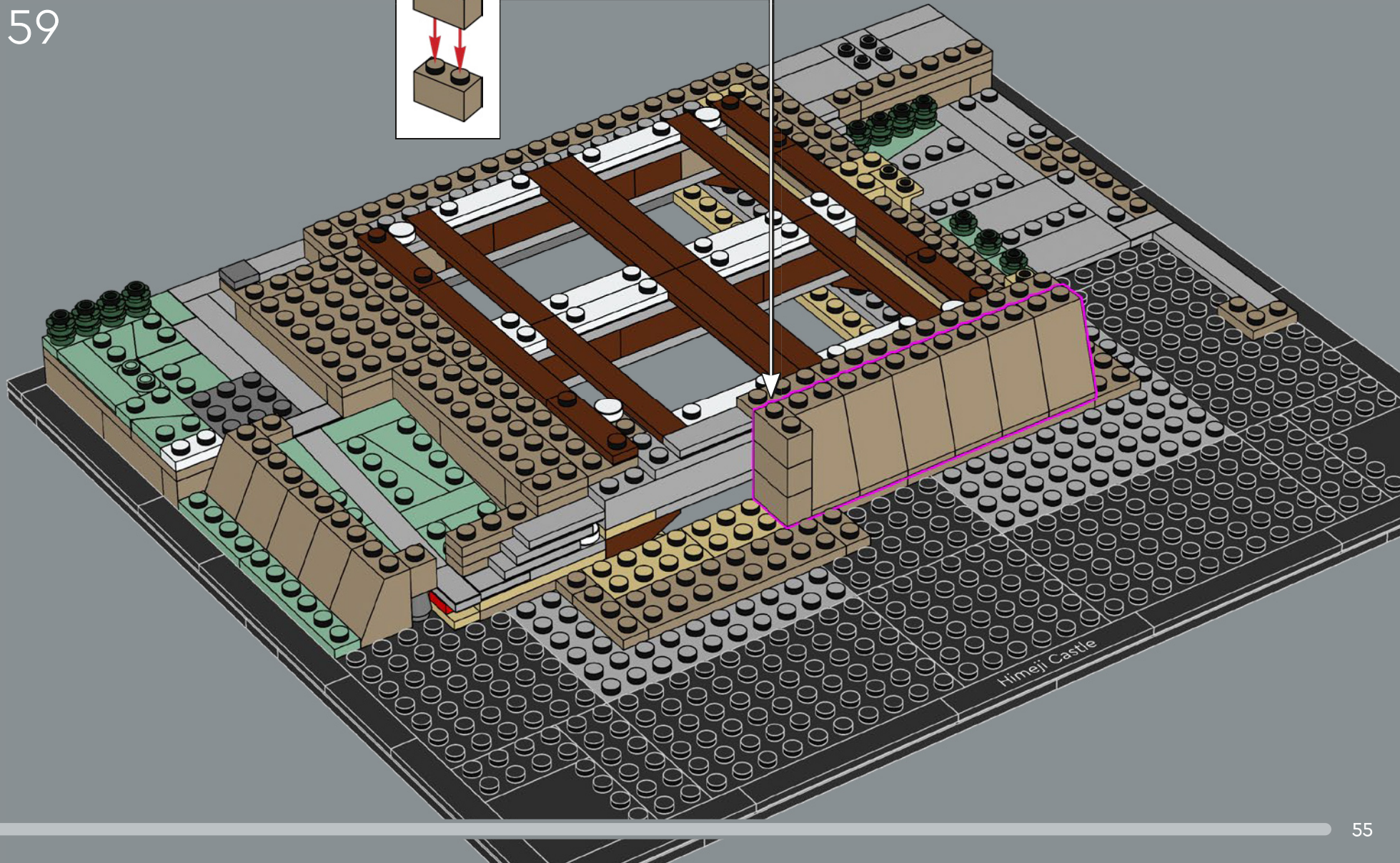



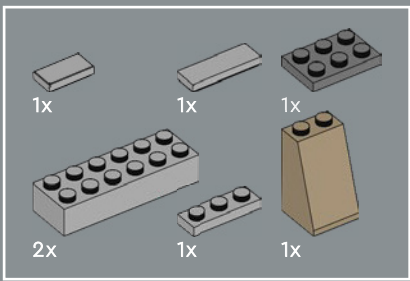

60

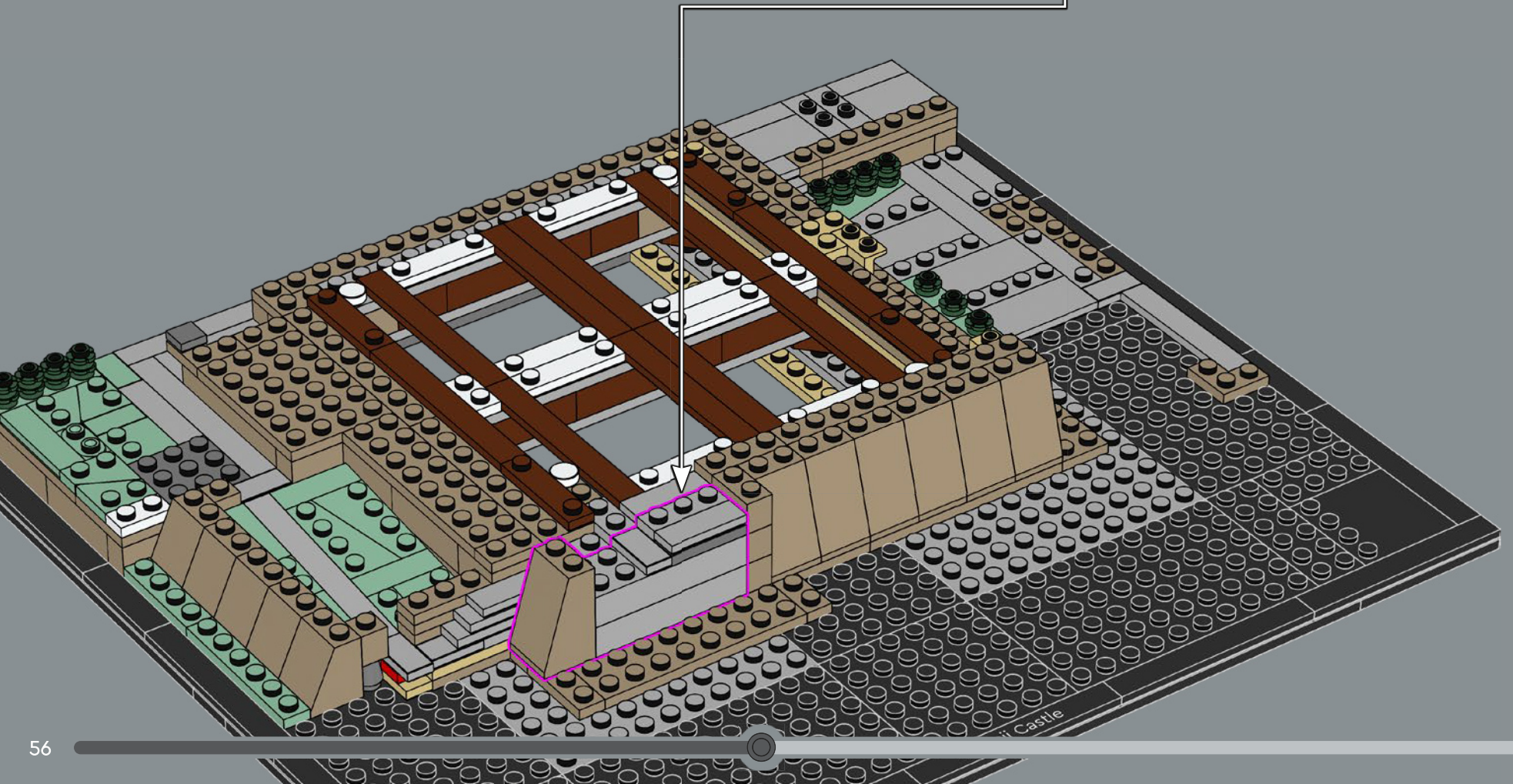
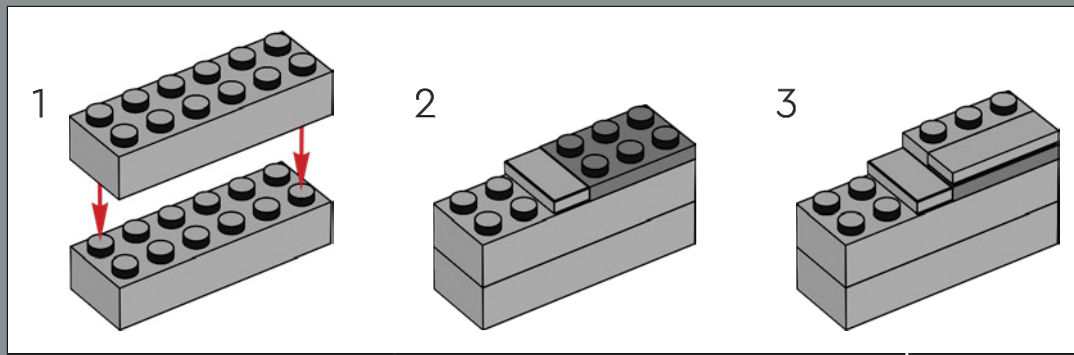



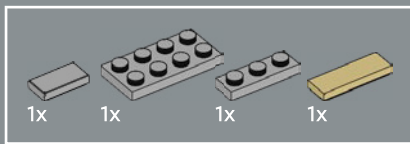

61

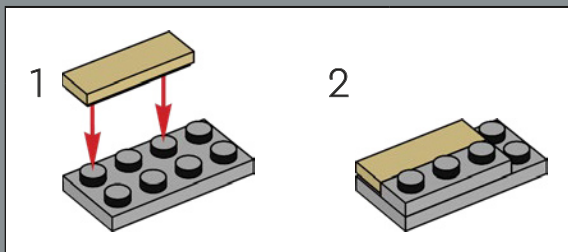
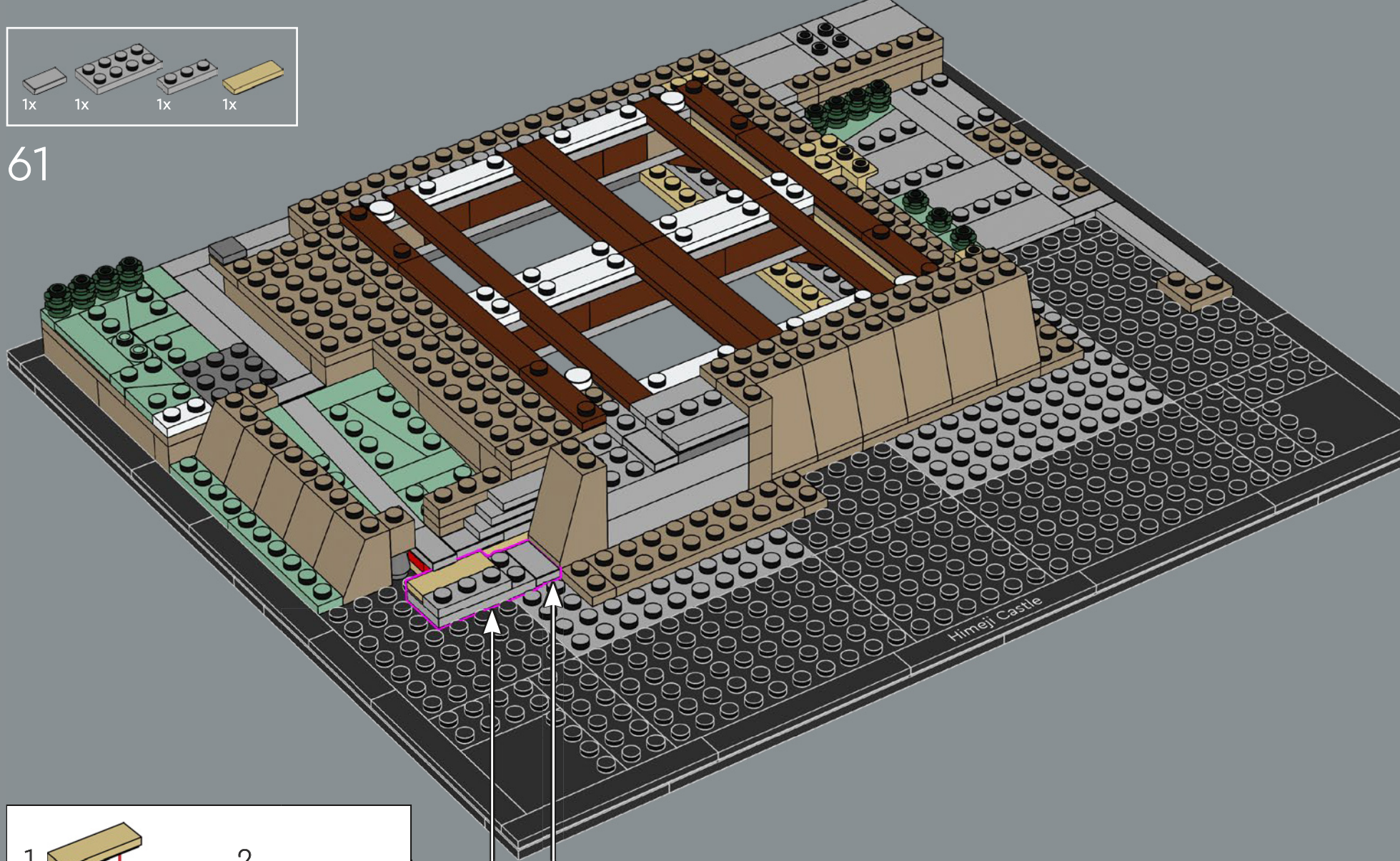



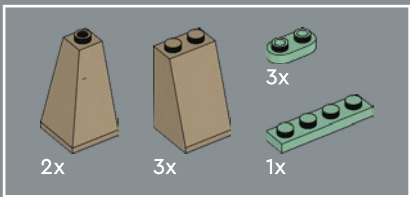

62

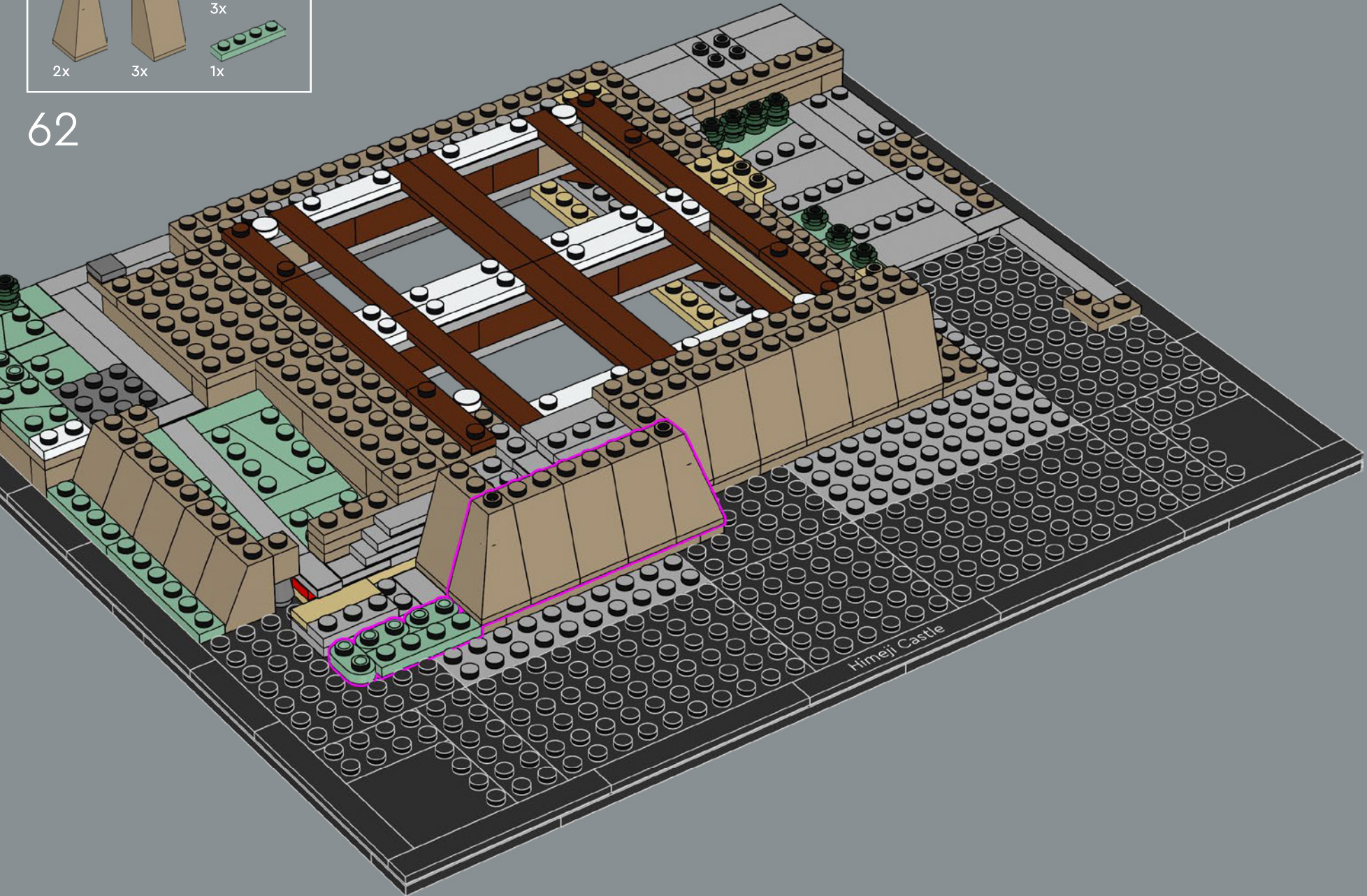



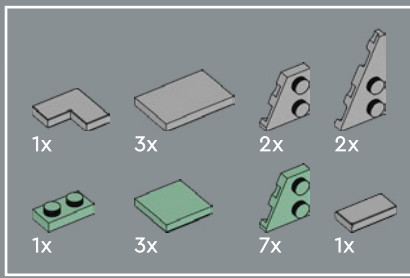

63

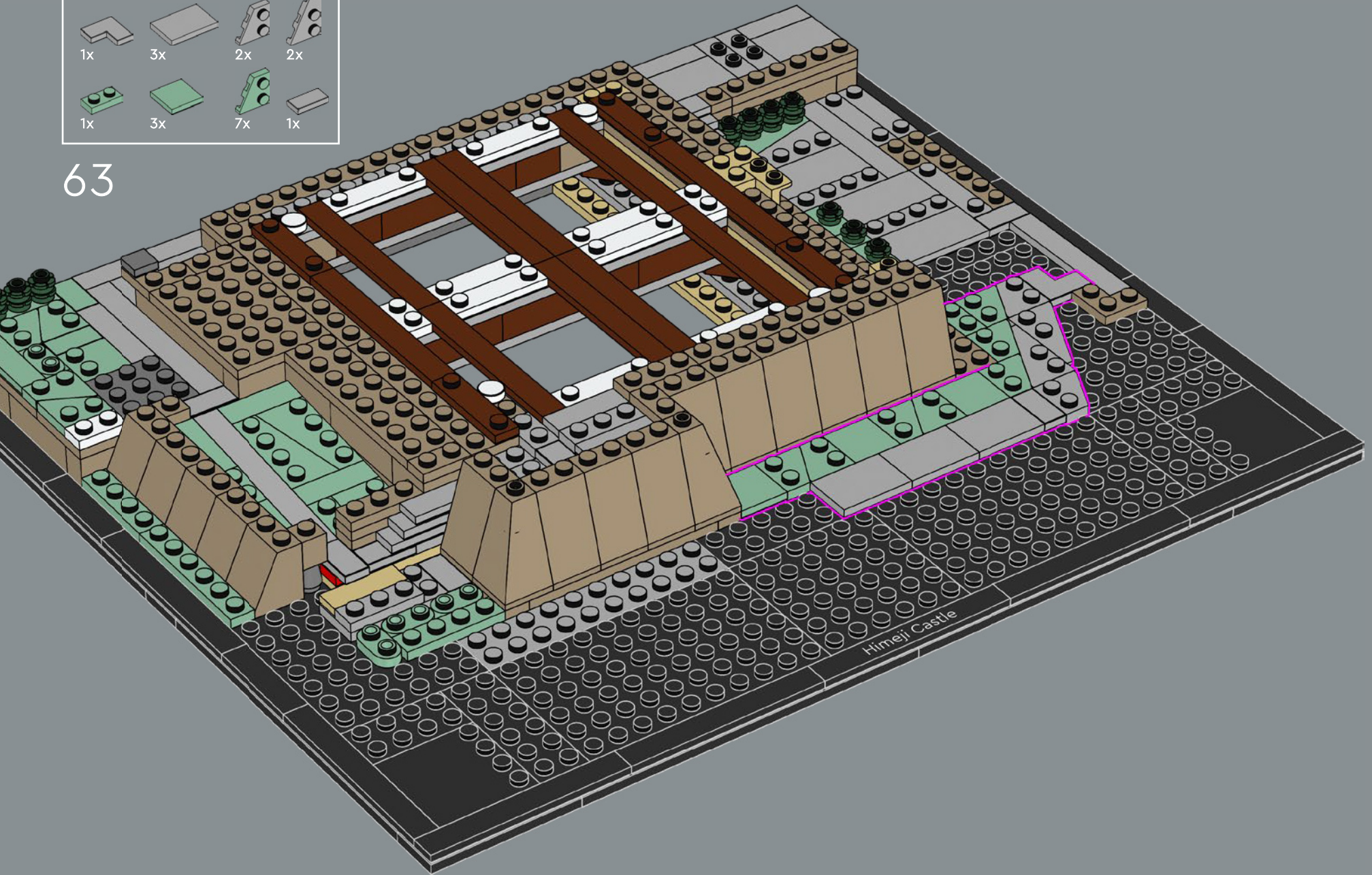



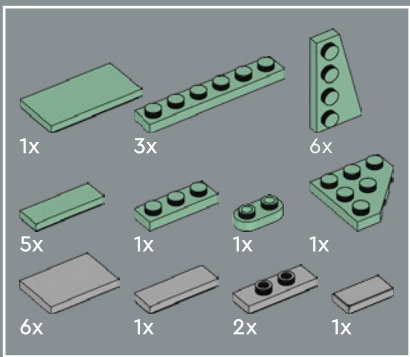

64

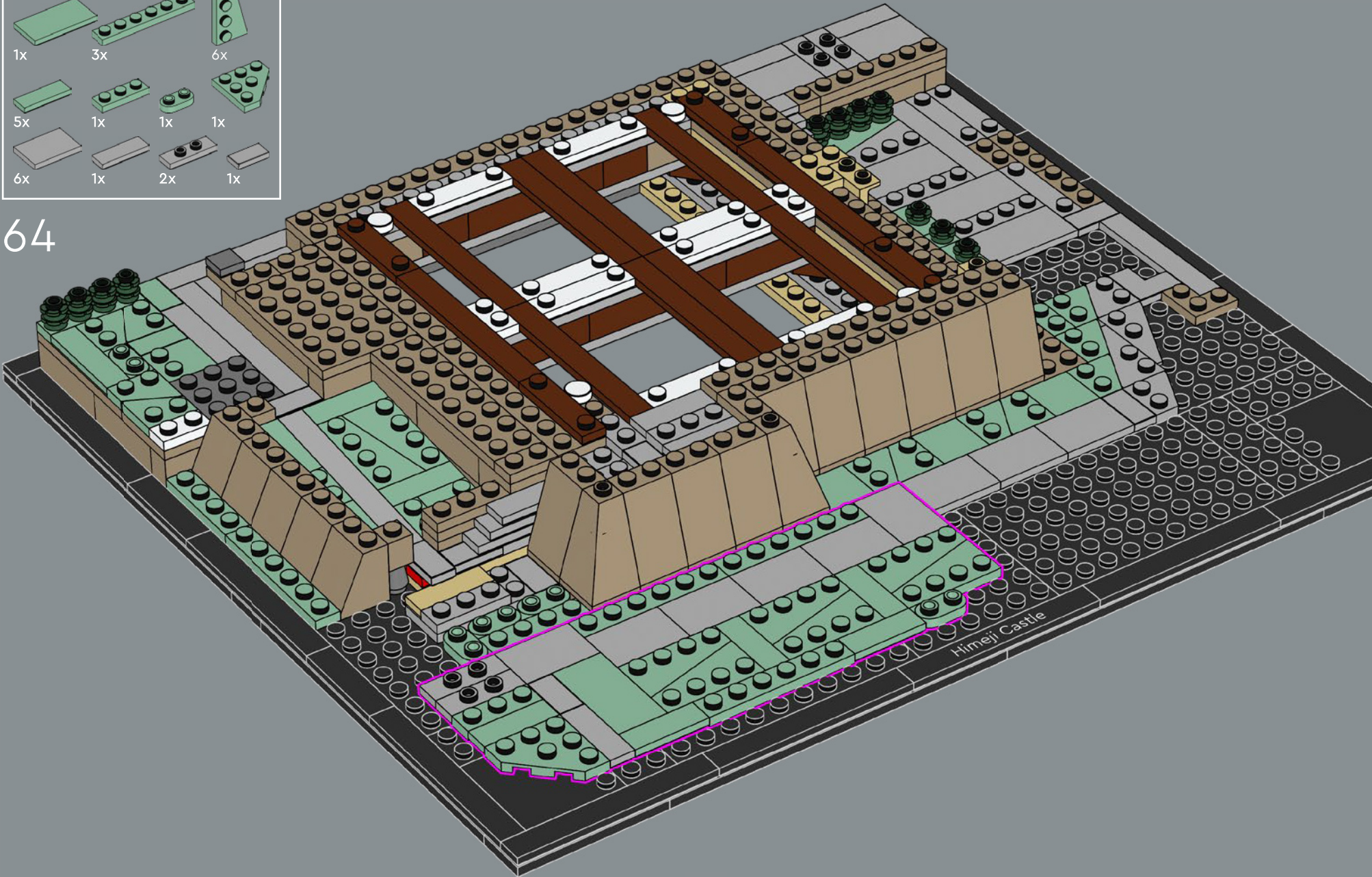



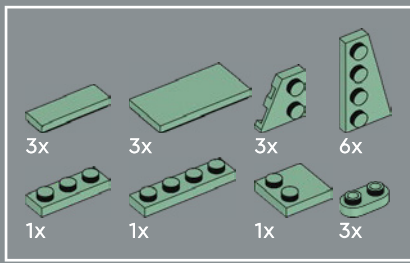

65

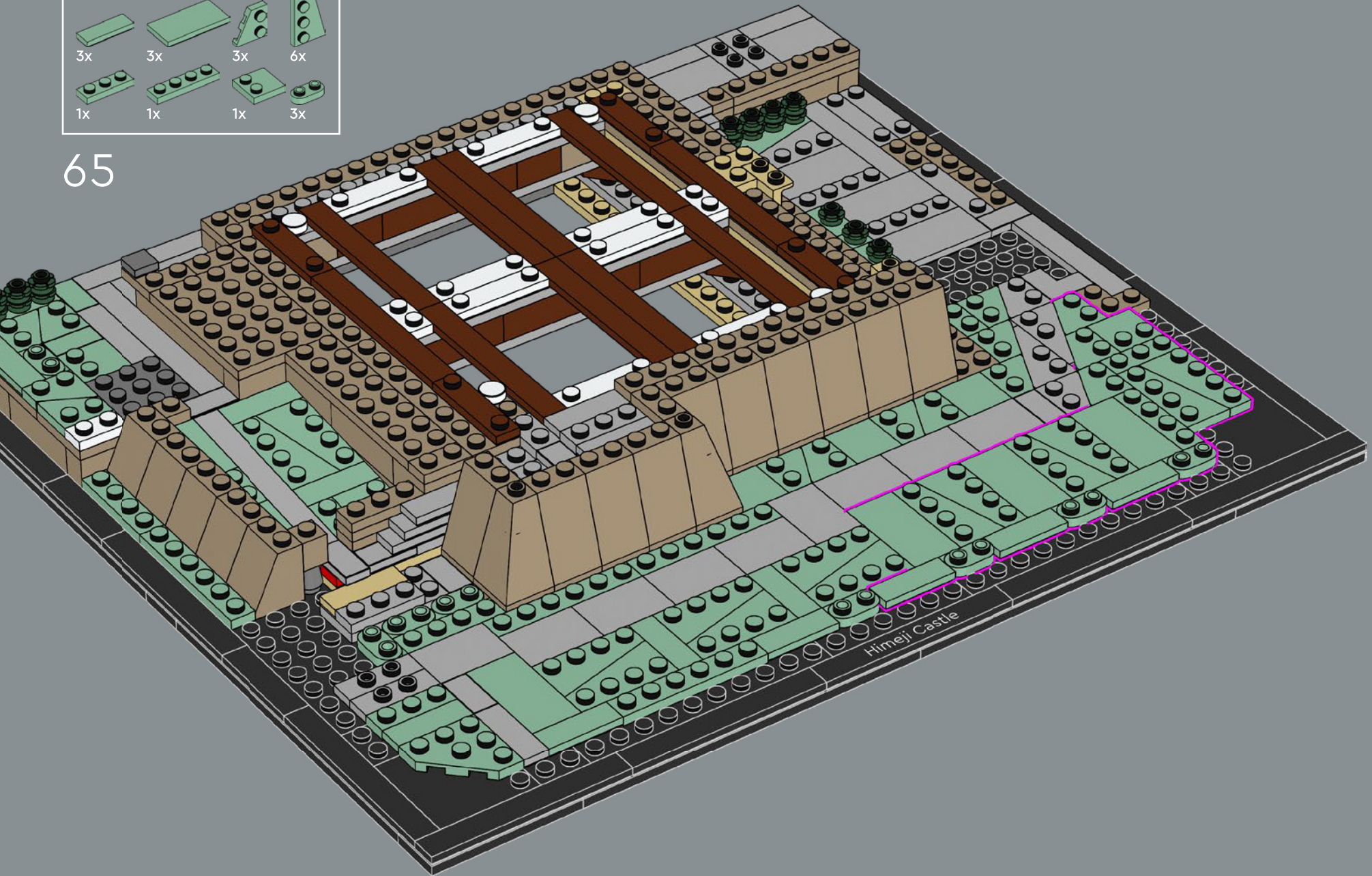



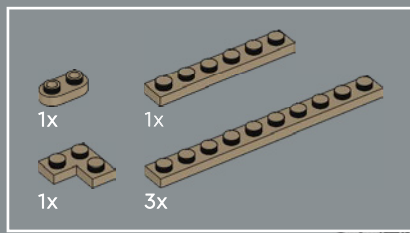

66

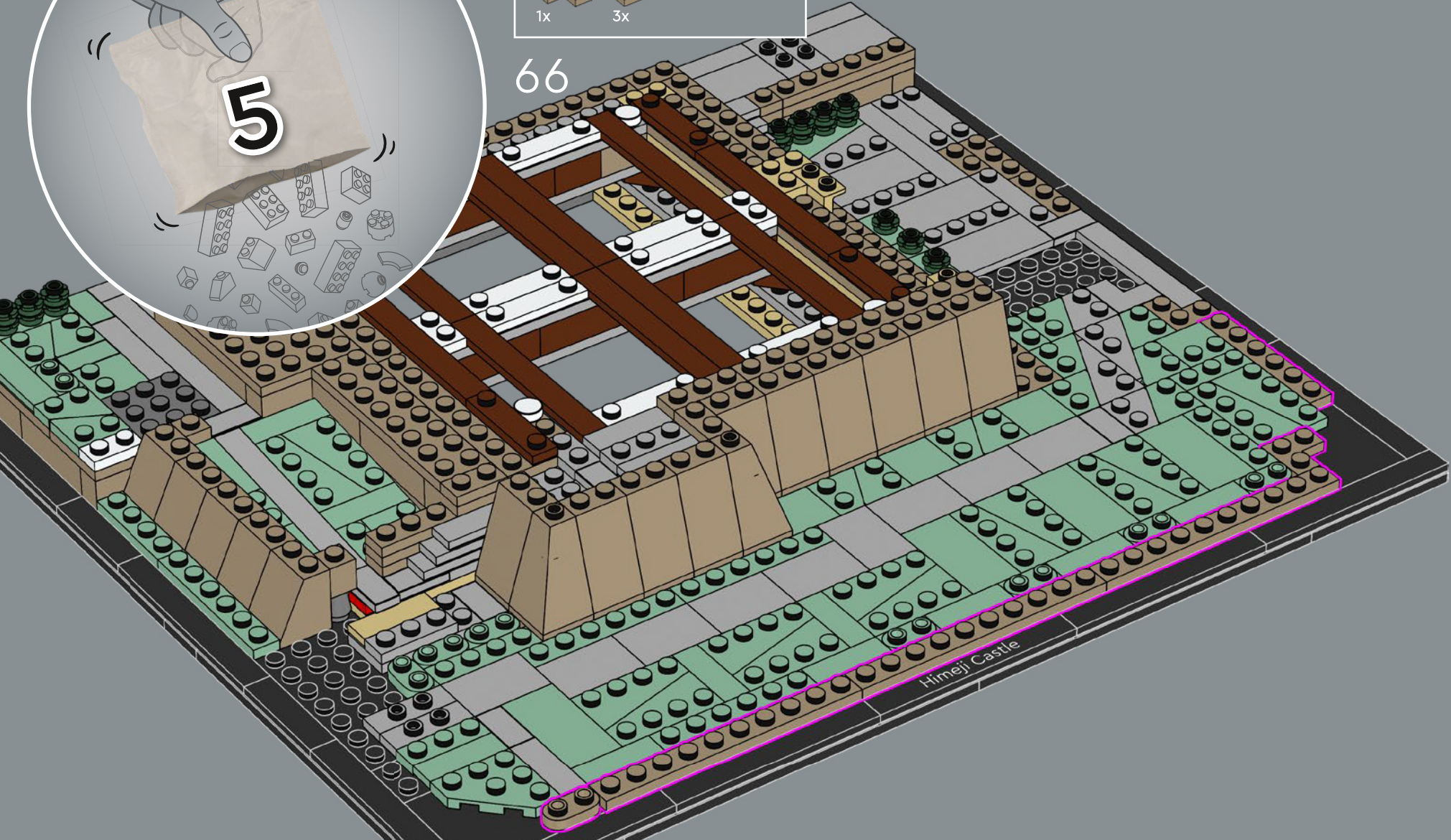



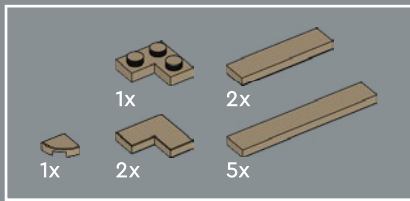

67

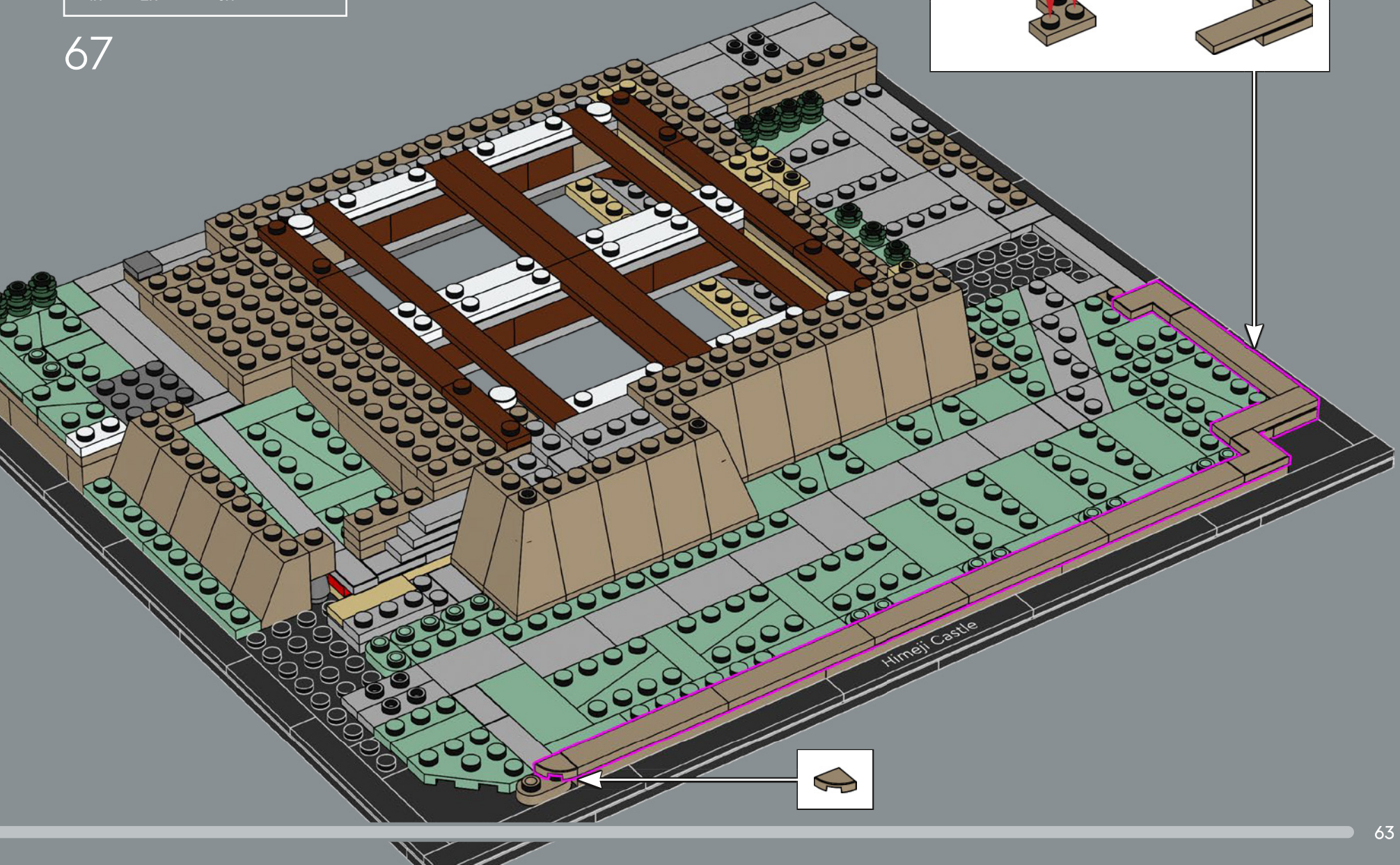
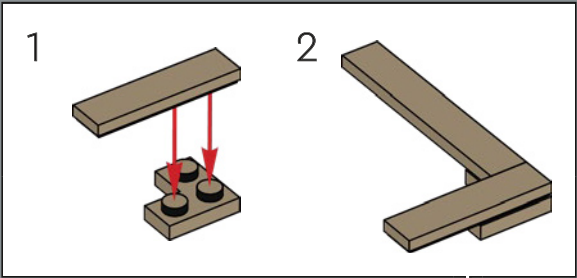

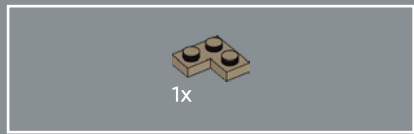

68

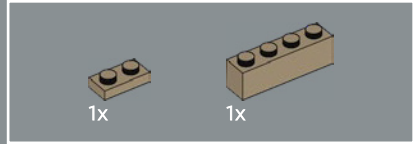

69

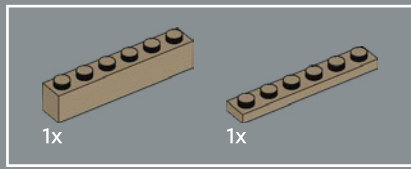
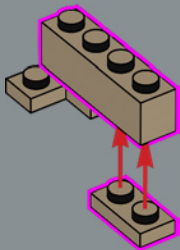

70

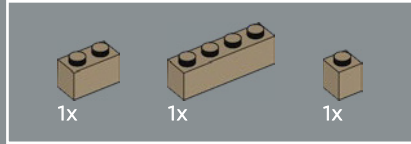
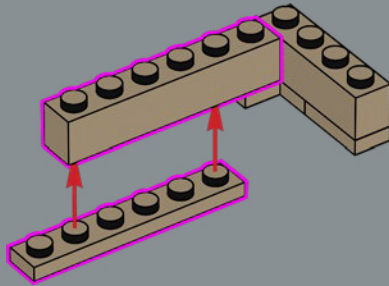

71

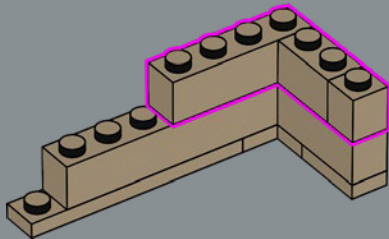

72

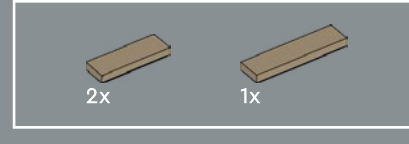
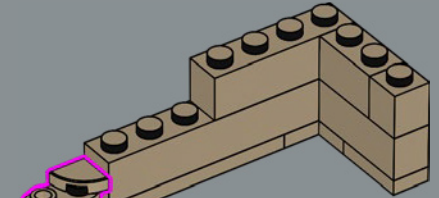
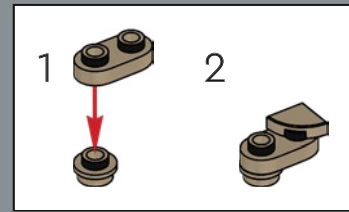

73

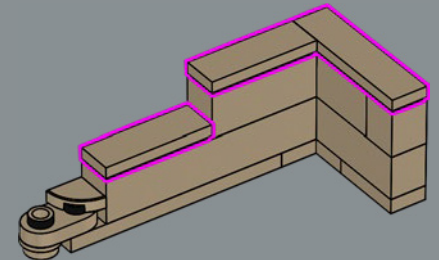



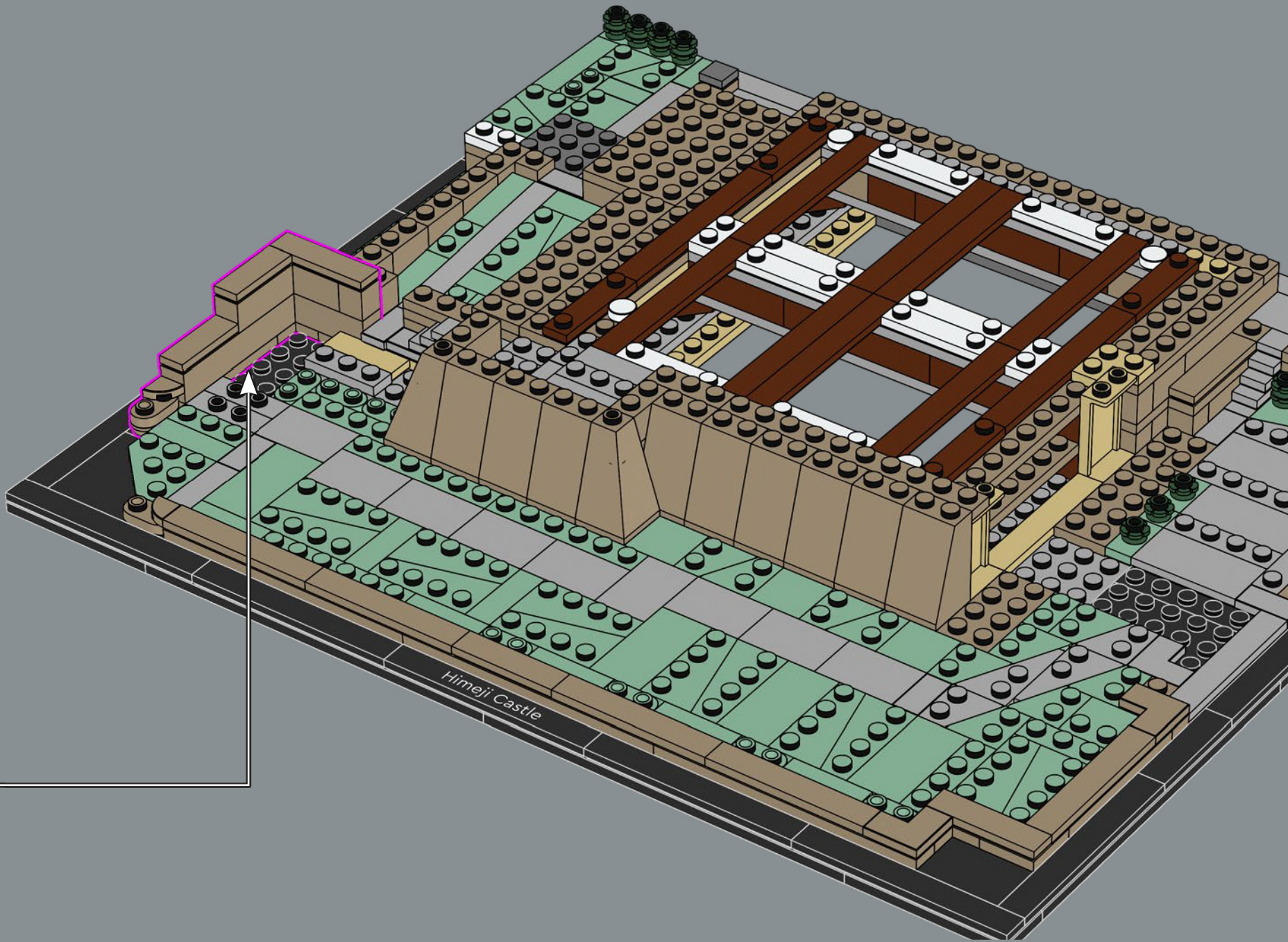



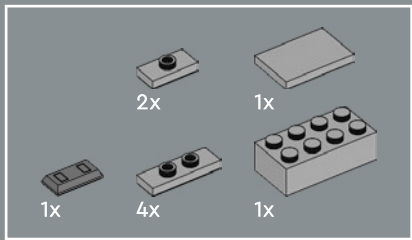

75

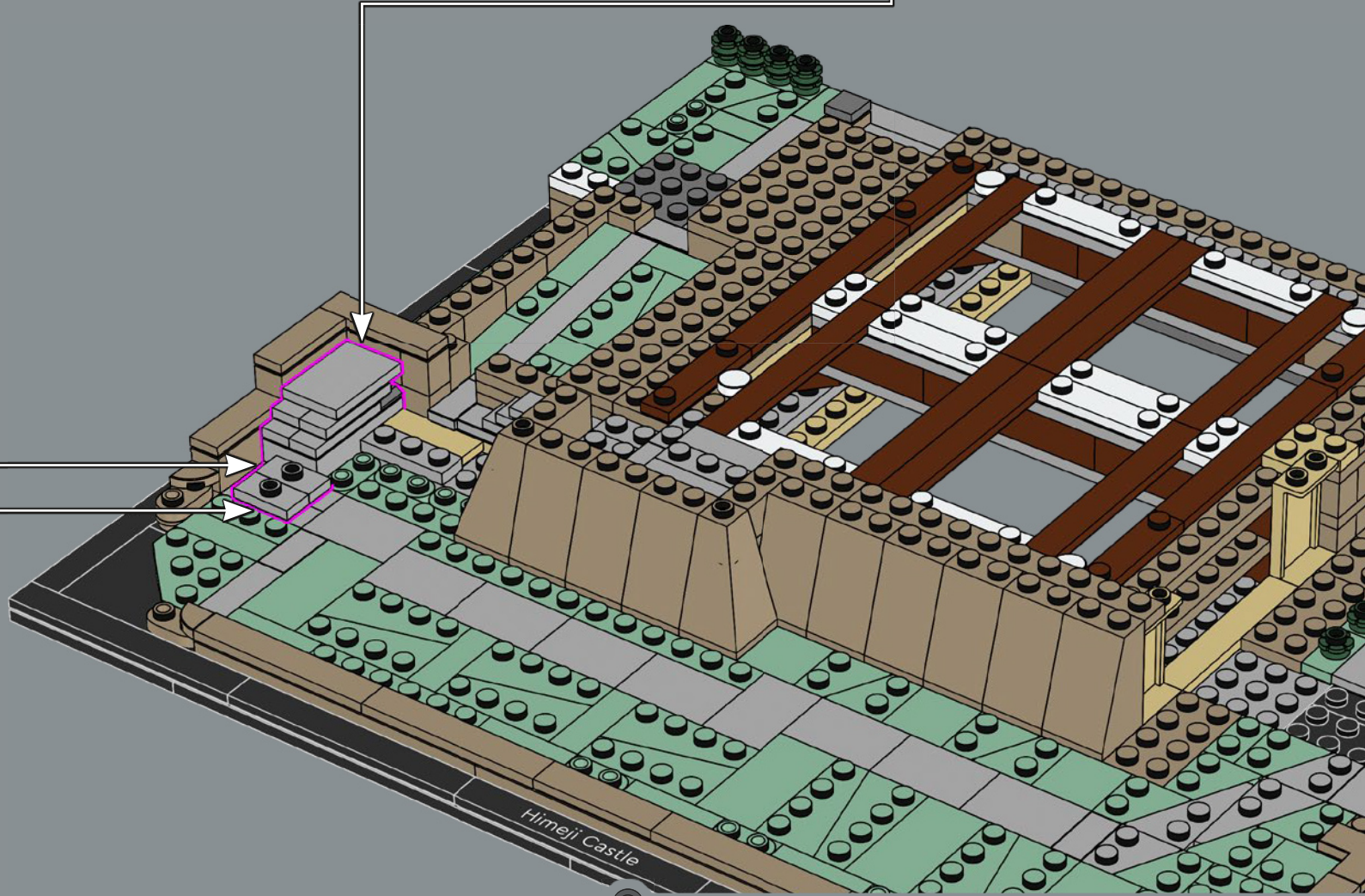
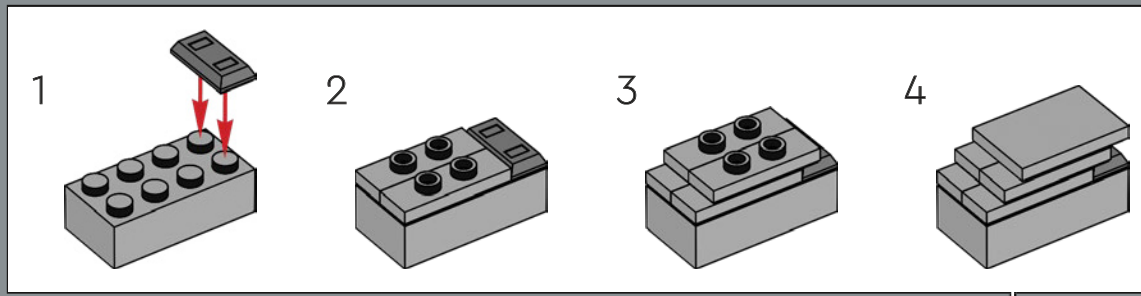



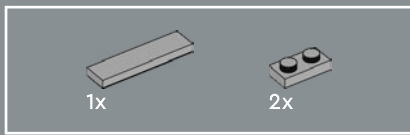

76

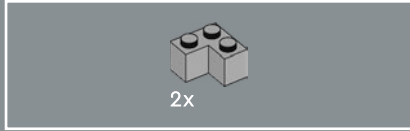
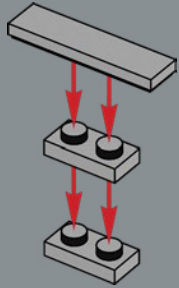

77

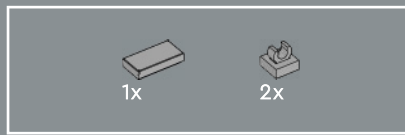
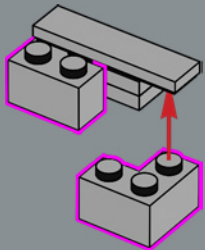

78

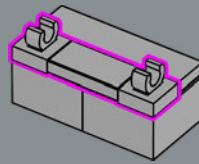

79

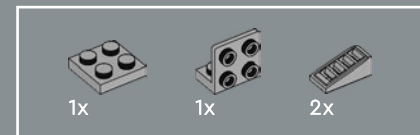
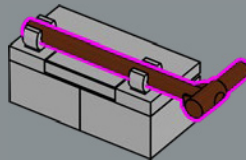

80

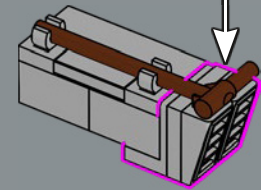
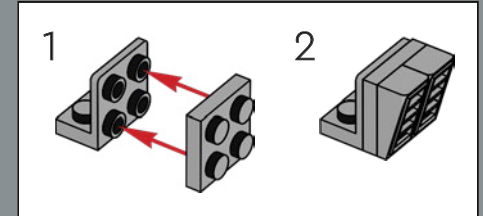

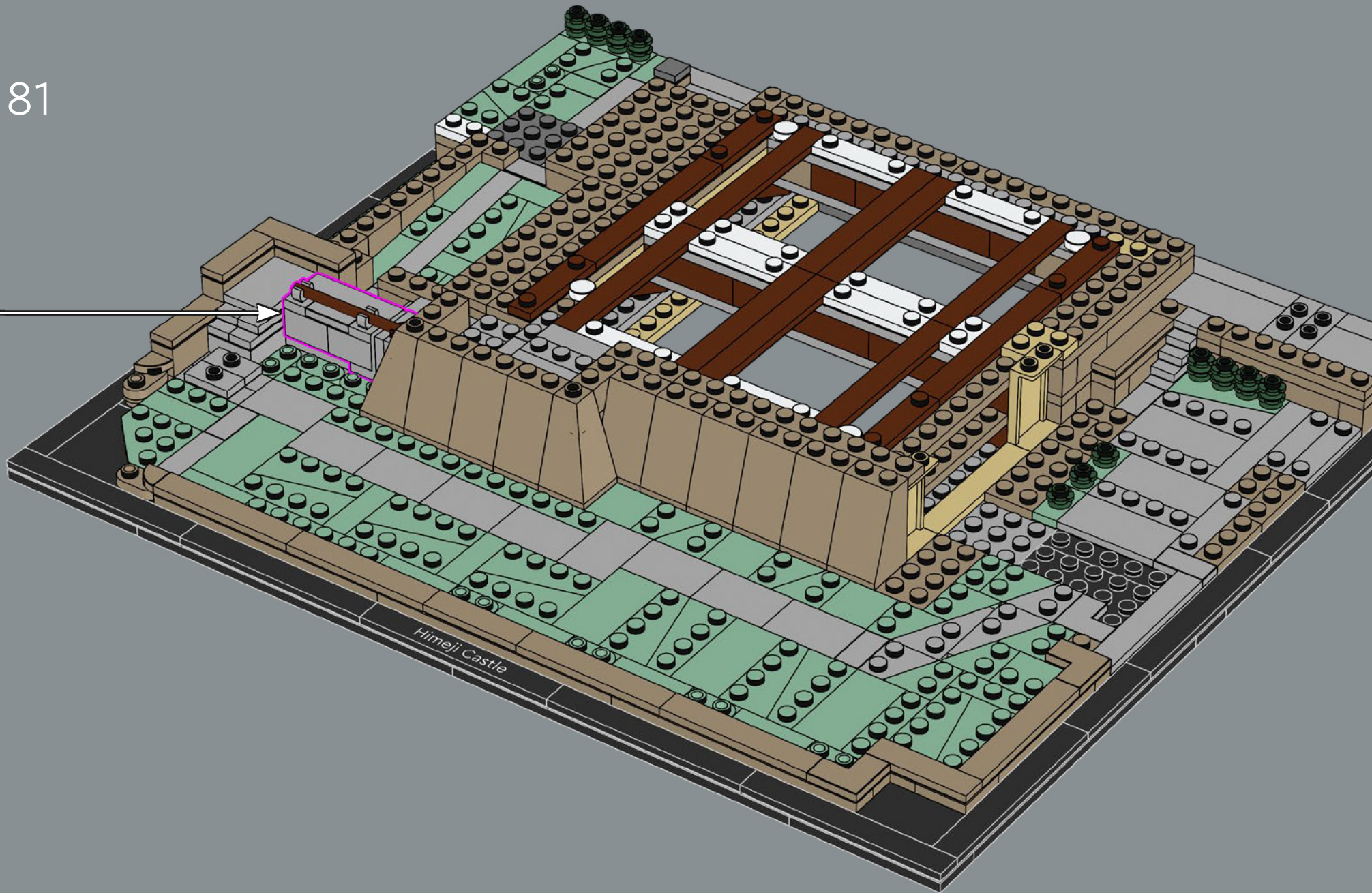



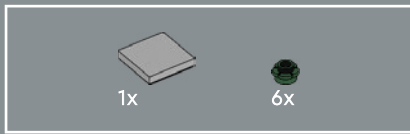

82

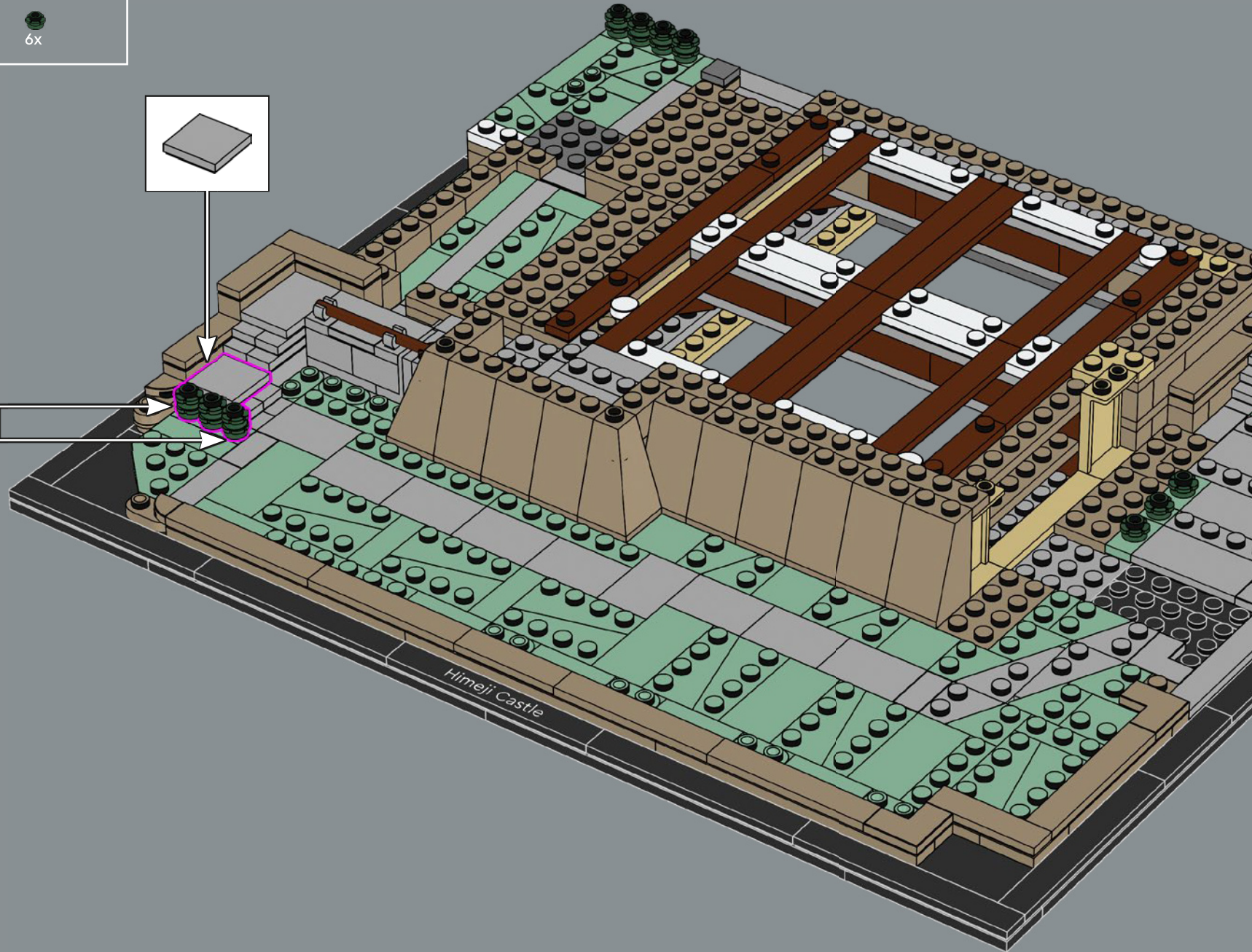
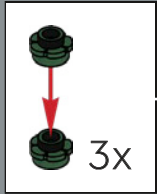



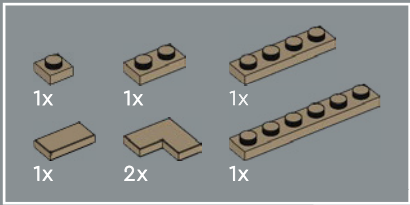

83

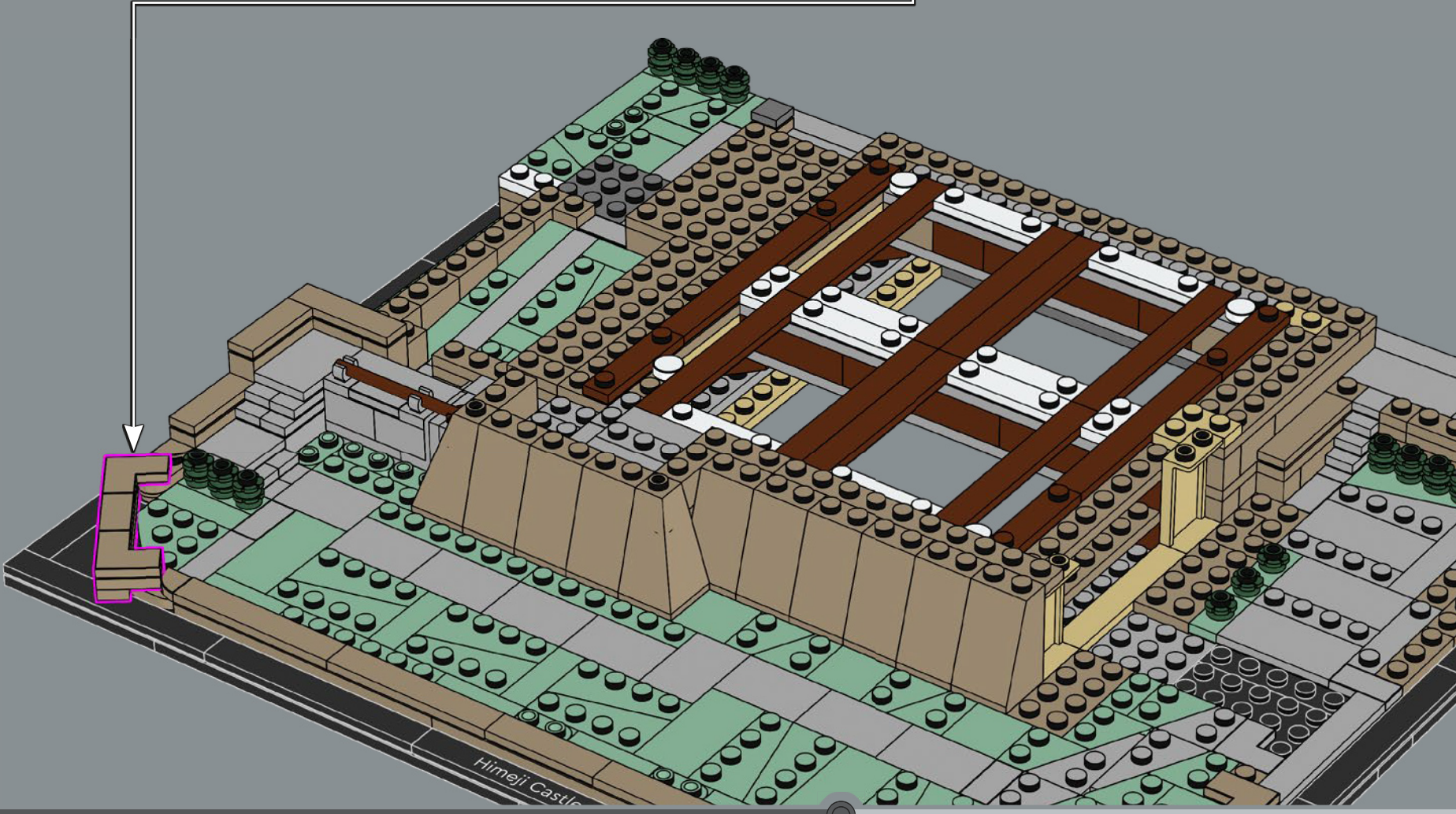
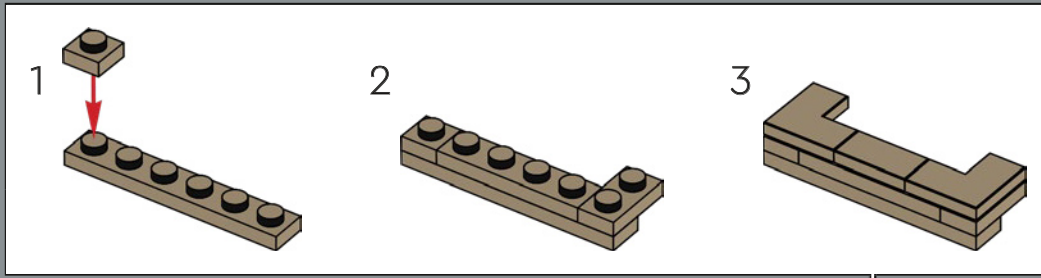



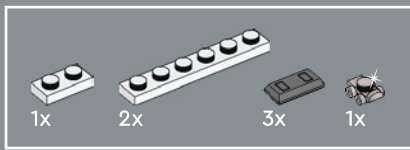

84

1

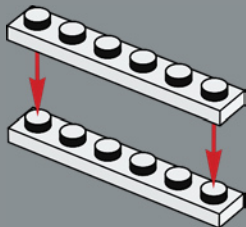

2

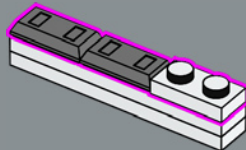

3

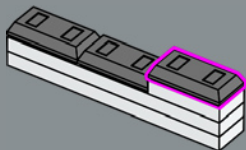

4



1:1

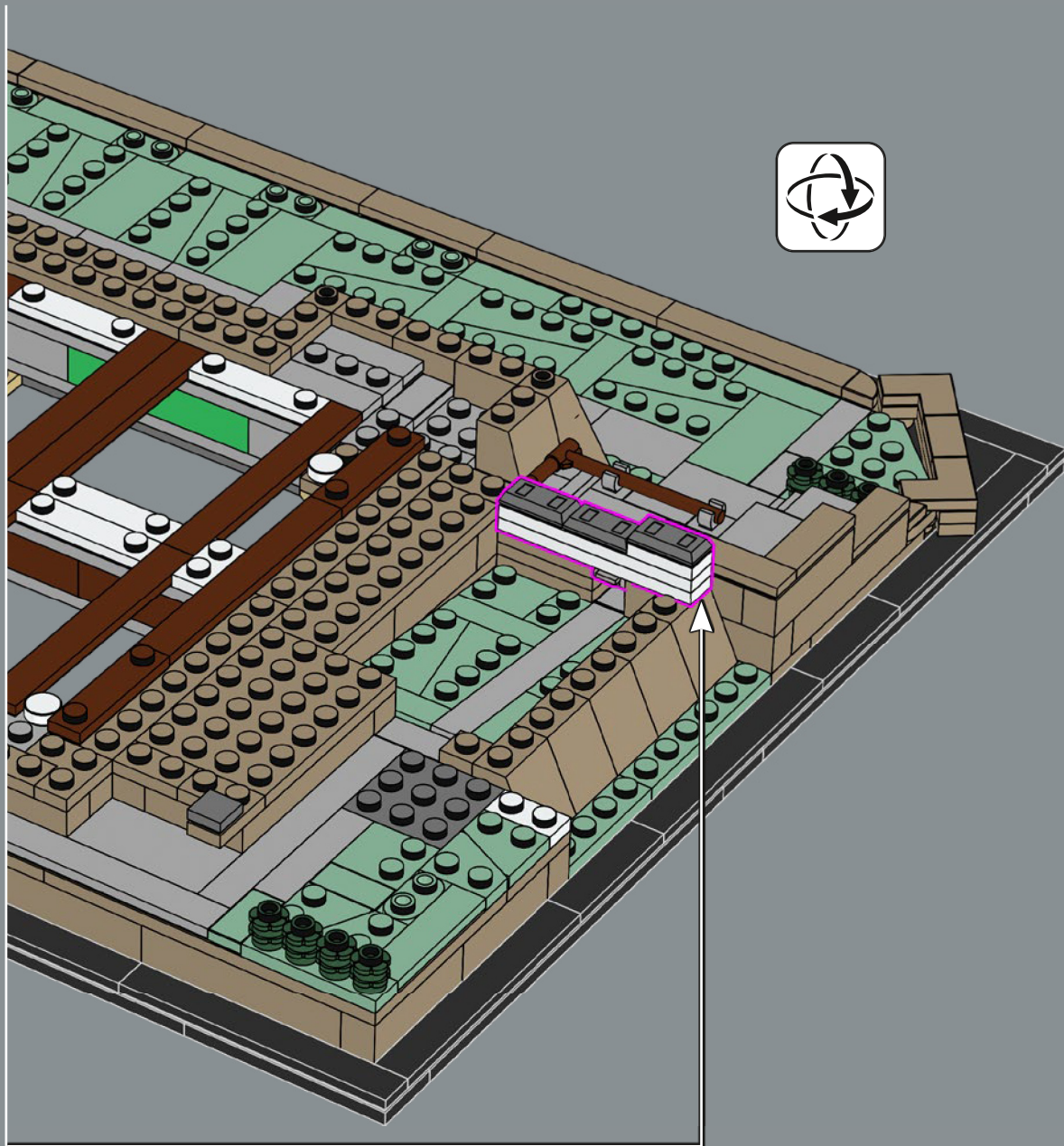



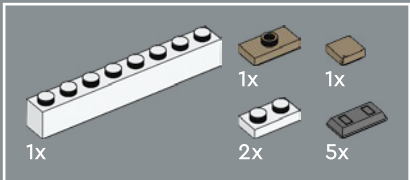

85

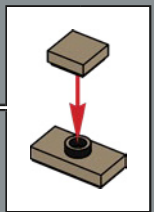
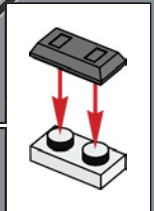
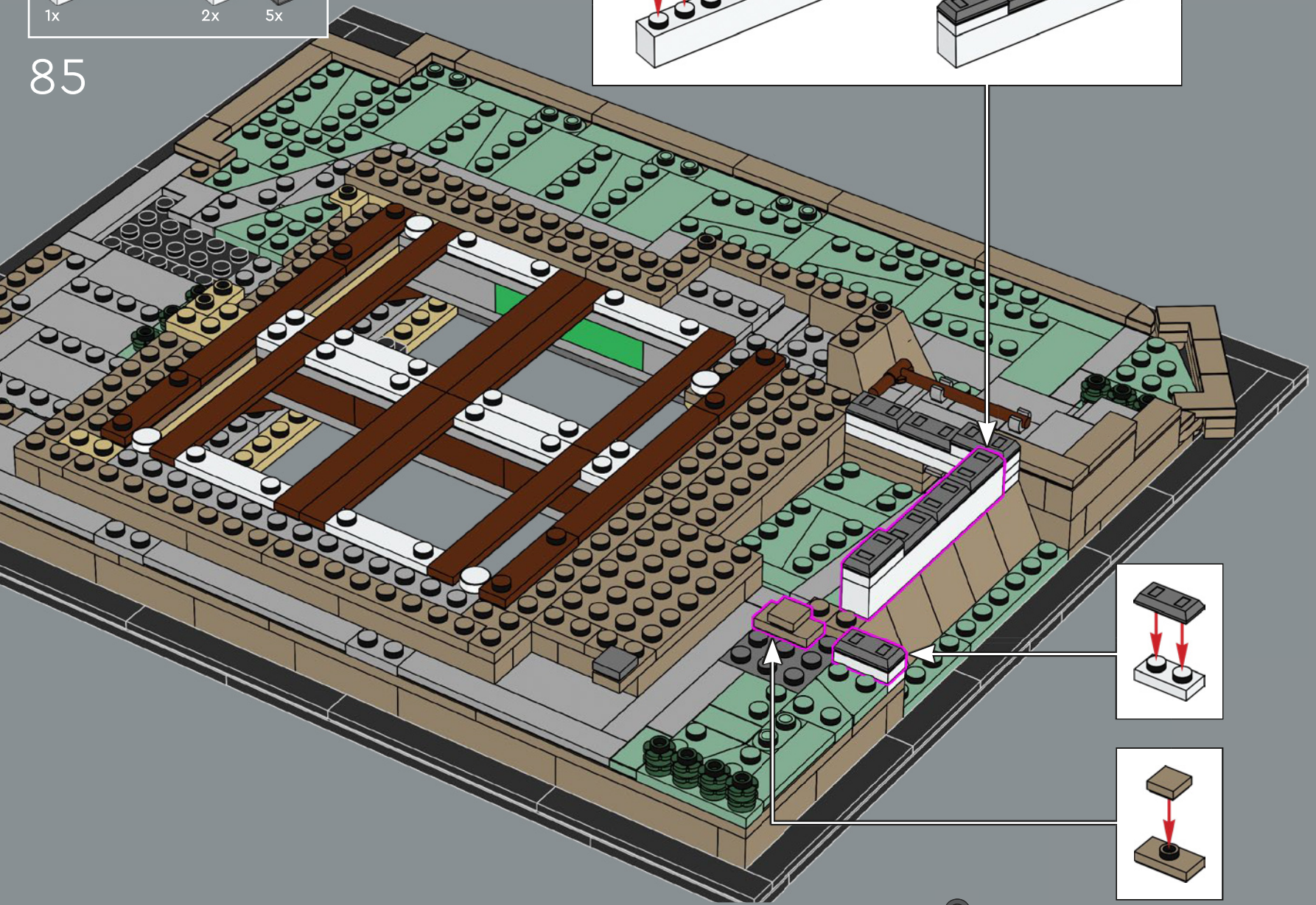
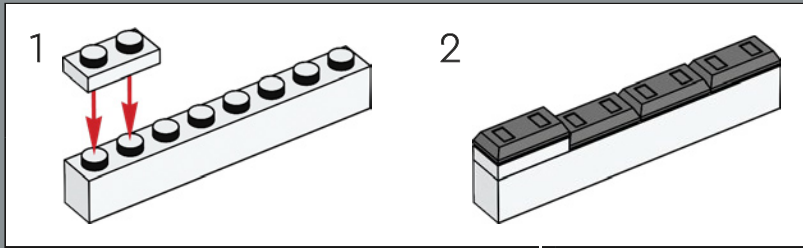



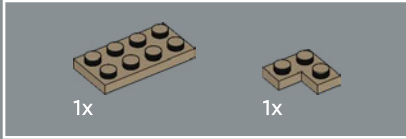
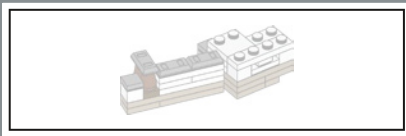

86

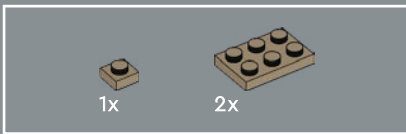
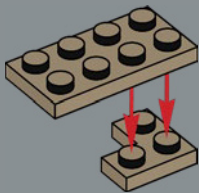

87

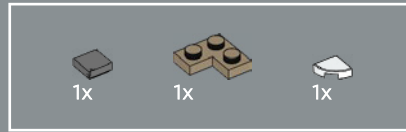
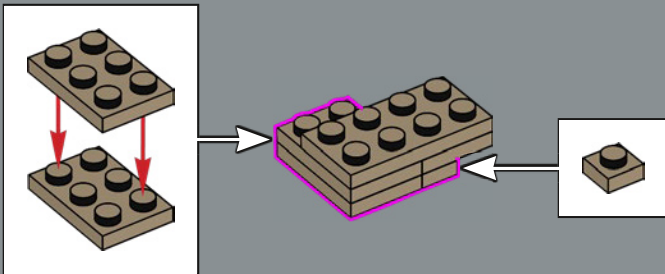

88

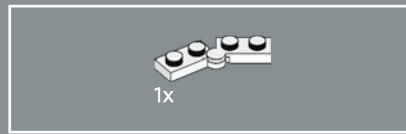
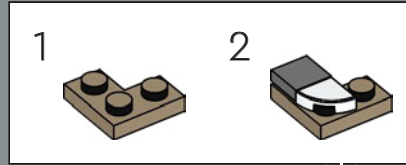

89

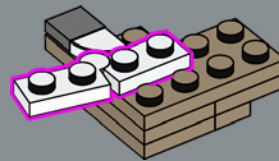

90

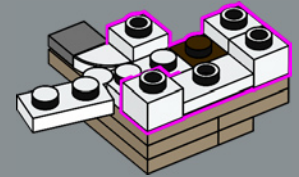

91

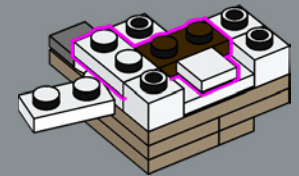

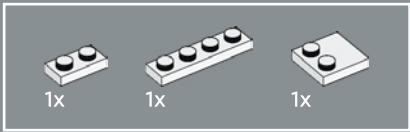

92

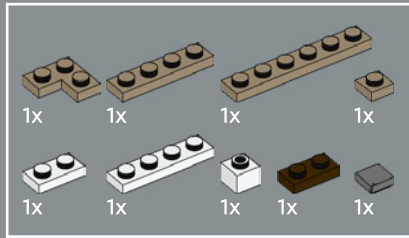
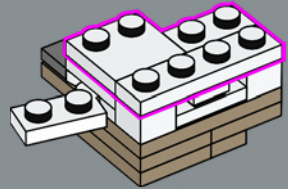

93

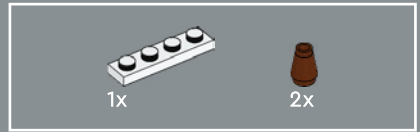
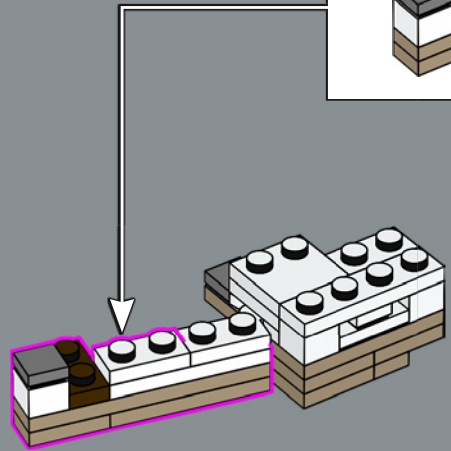
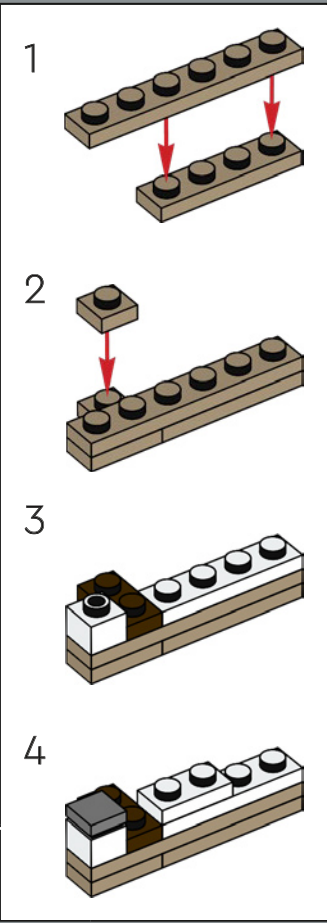

94

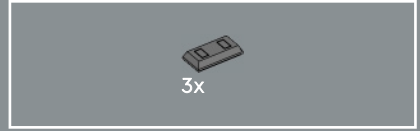
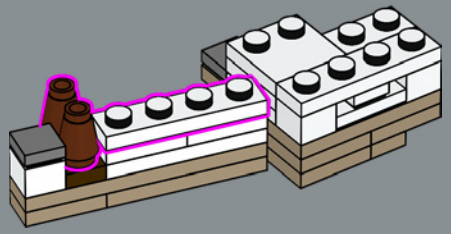

95

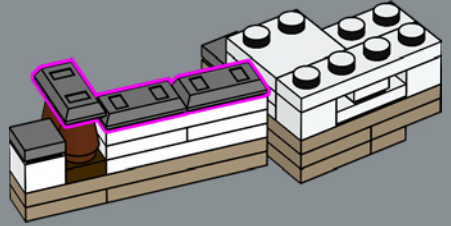



Die zahlreichen Mauern, Türme und Gänge sind in ungleichen Winkeln angeordnet. Und dies ist nur eine der Facetten, die die Architektur der Burg so interessant machen.

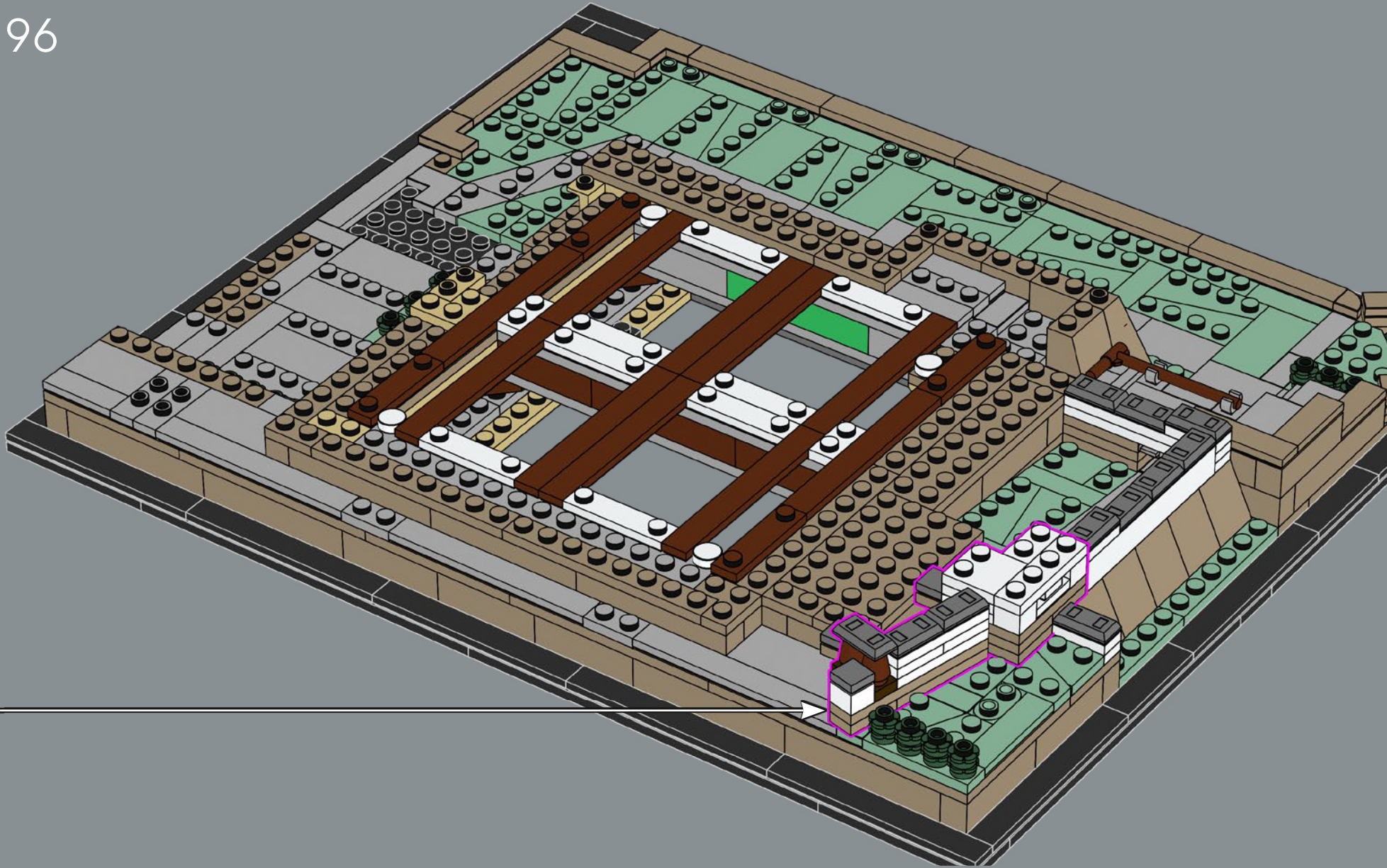



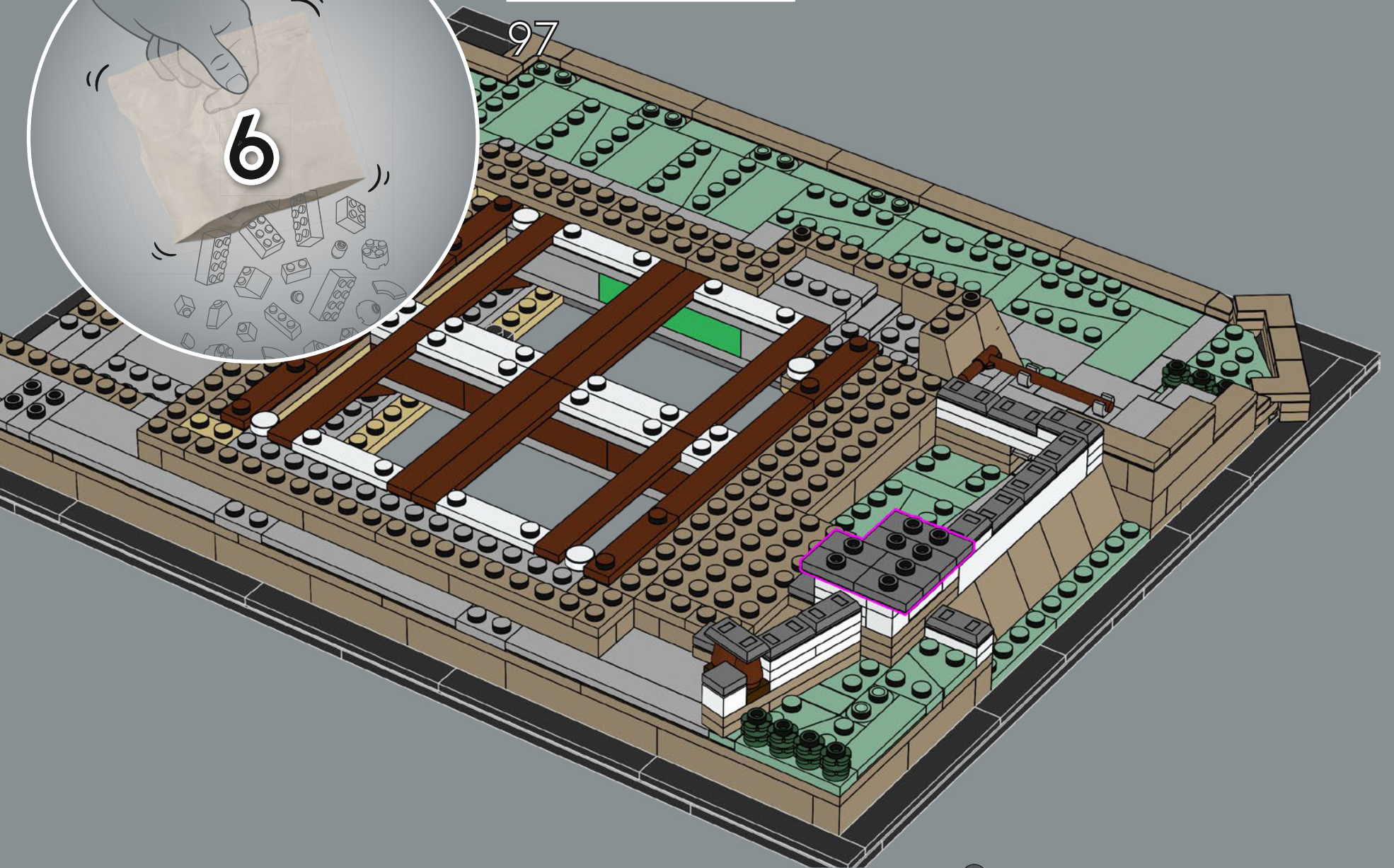
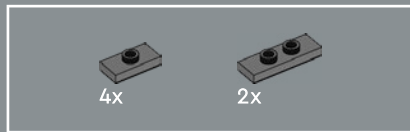



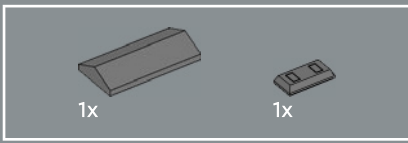

98

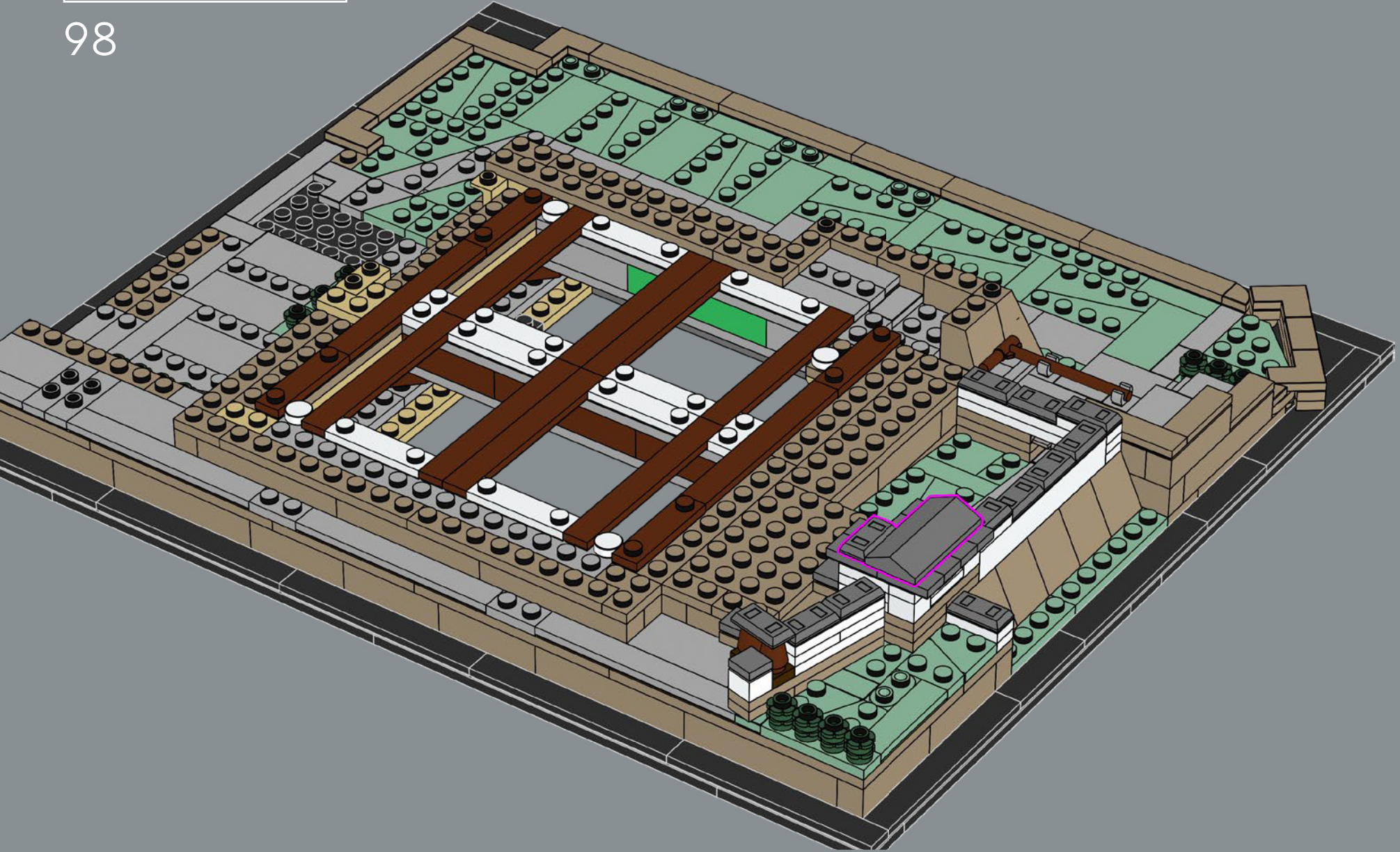



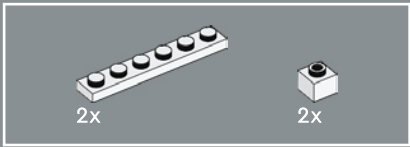

99

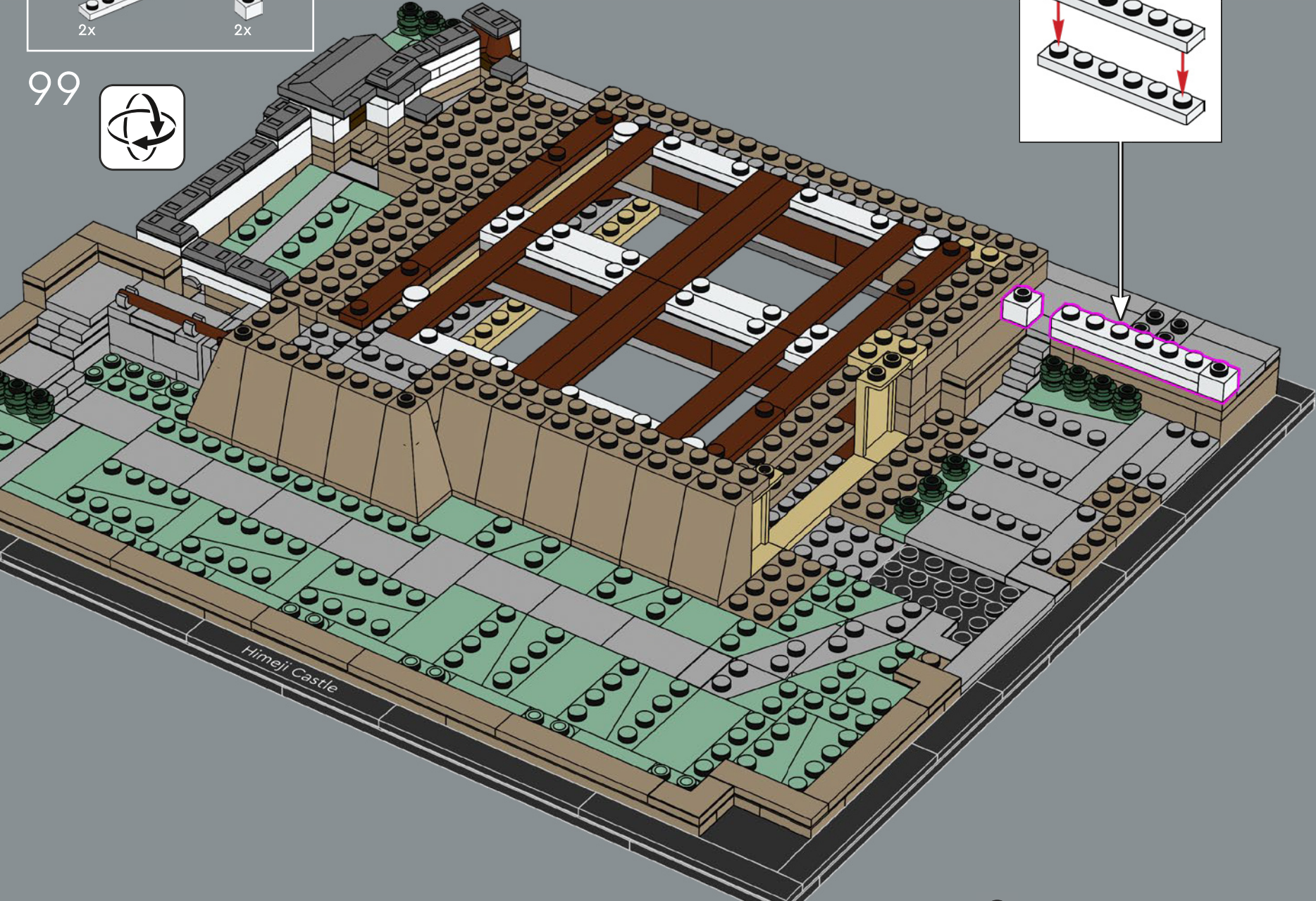
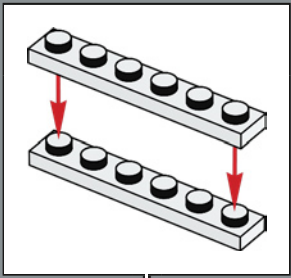

Himeji Castle





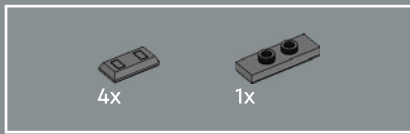

100

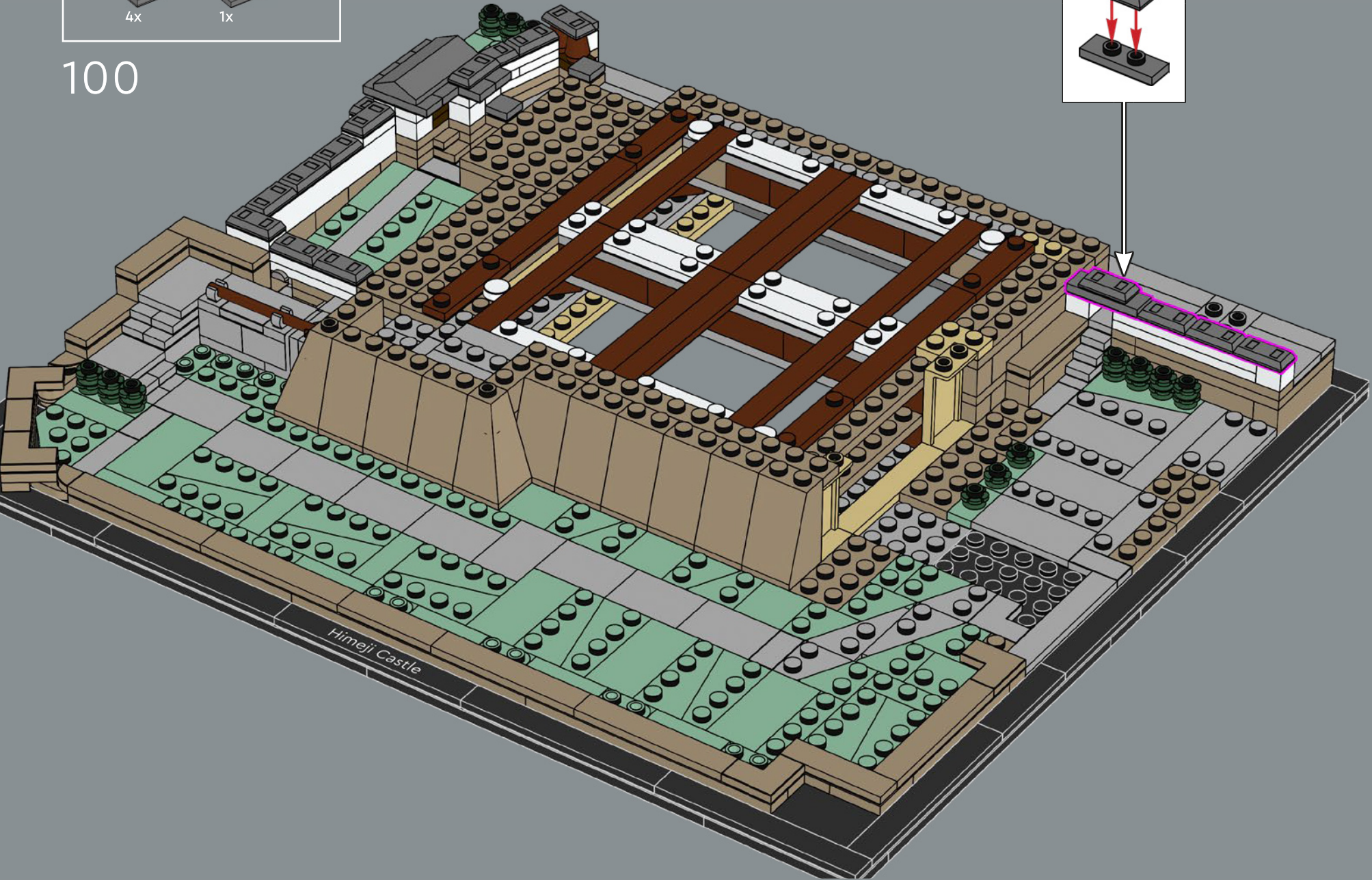
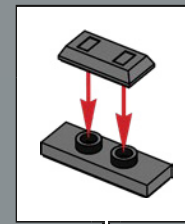

Himeji Castle

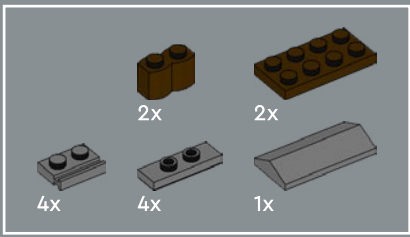

# 101

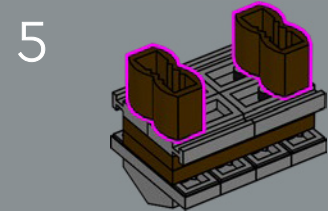
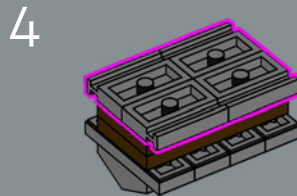
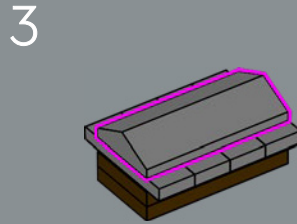
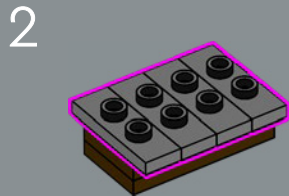
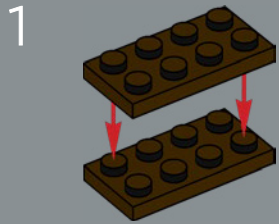



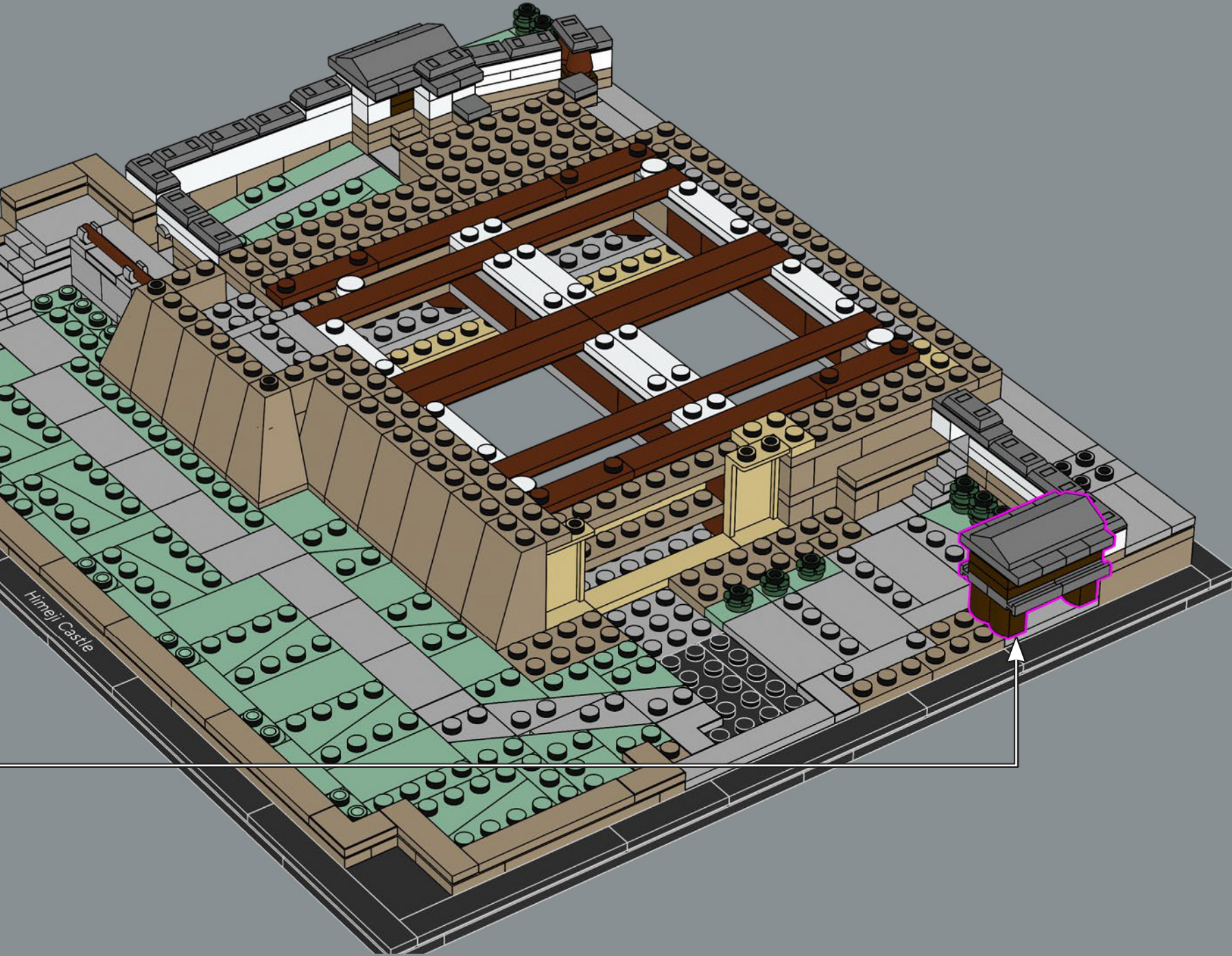

Himeji Castle

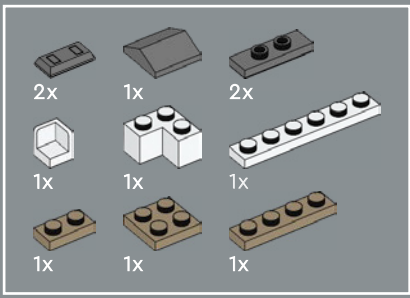

102

1

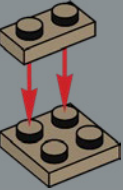

2

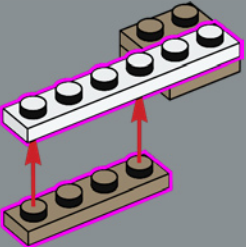

3

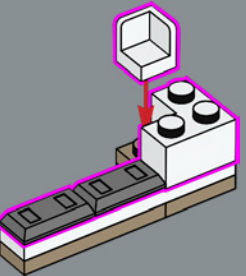

4

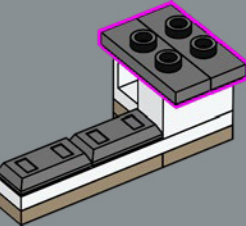

5

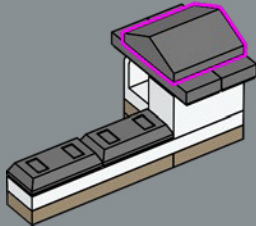



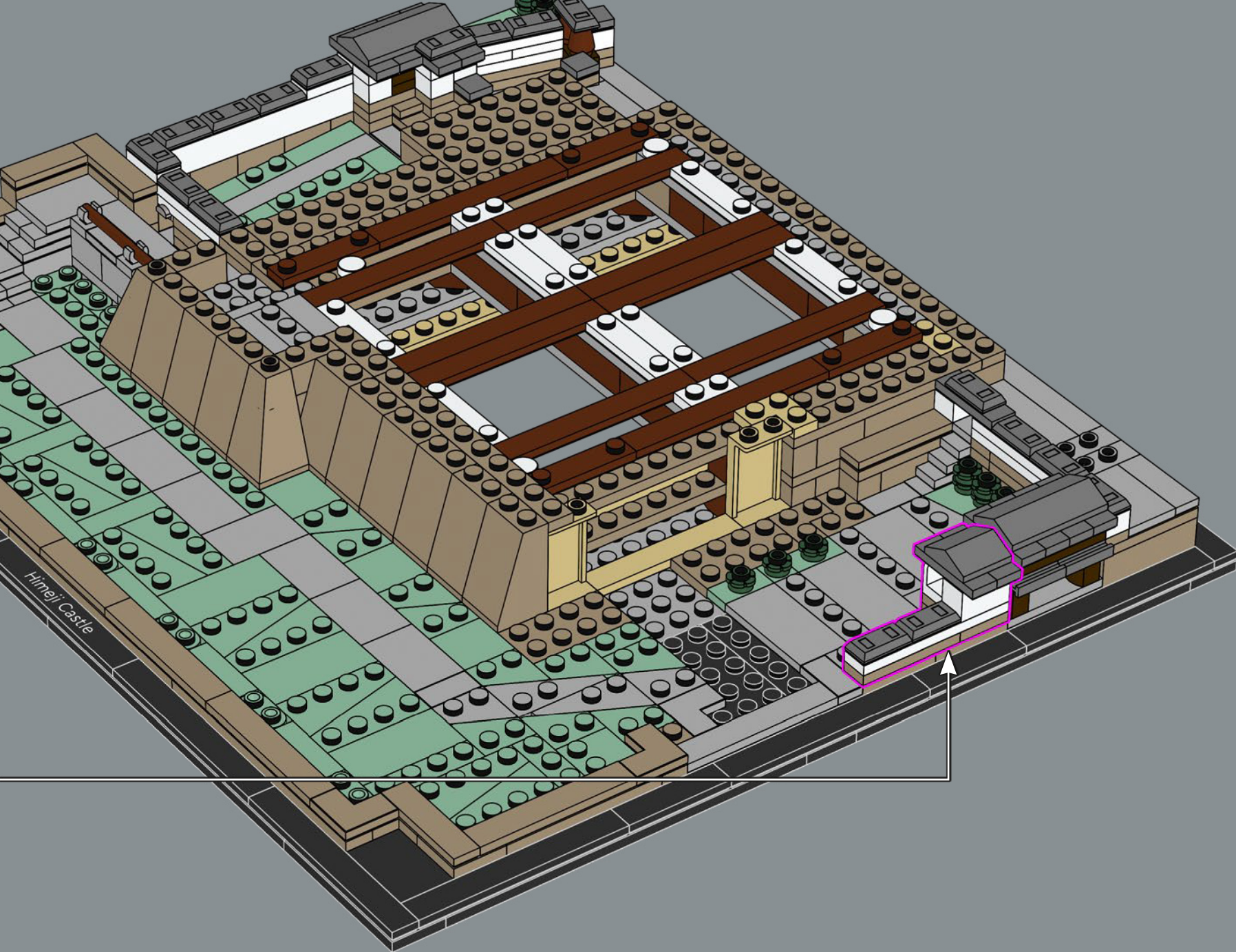



1x 2x 1x

103

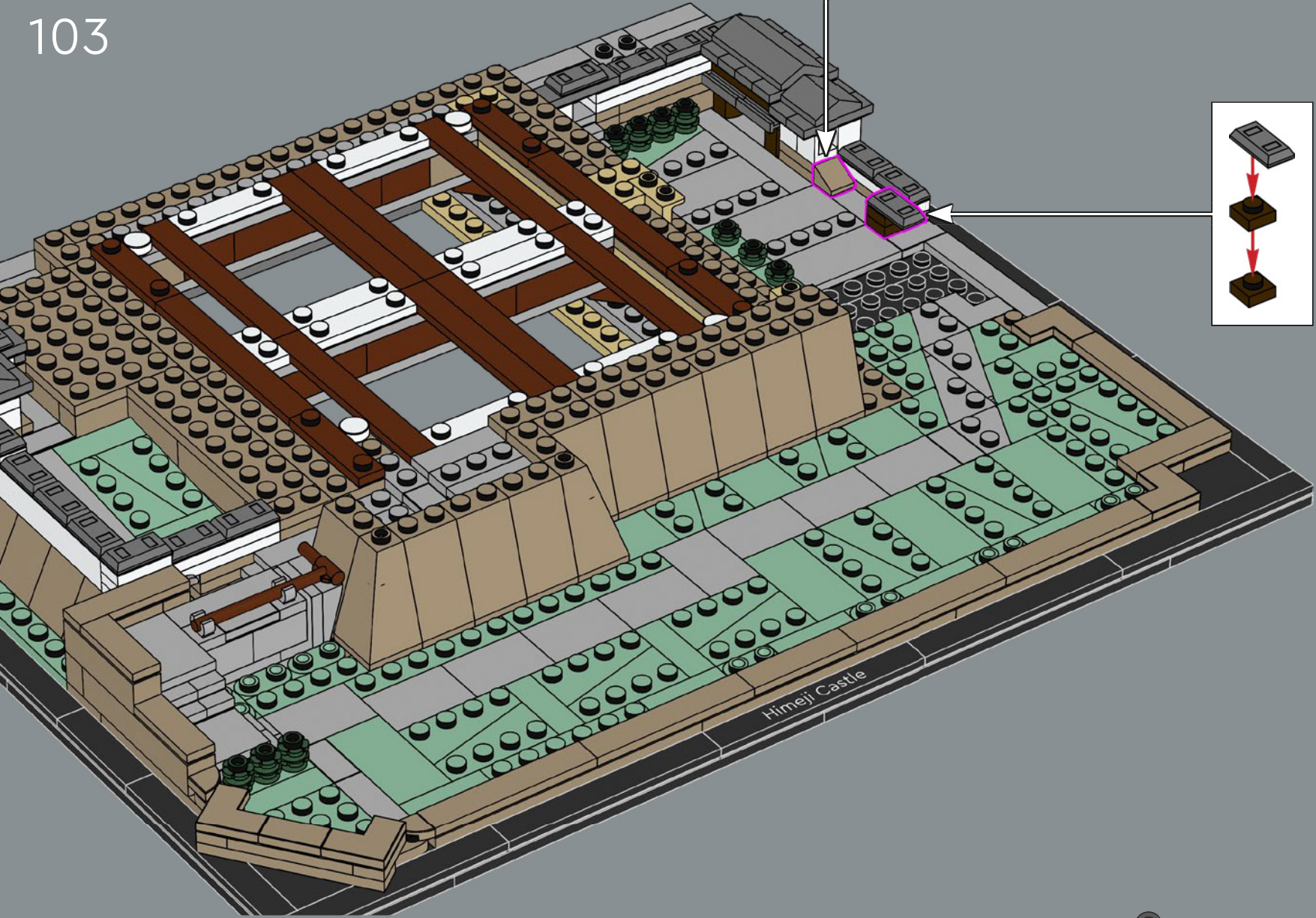
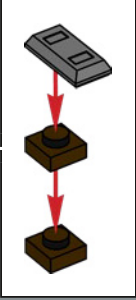

Himeji Castle





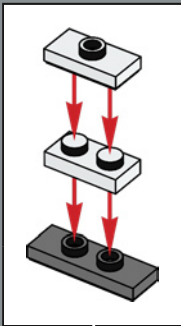
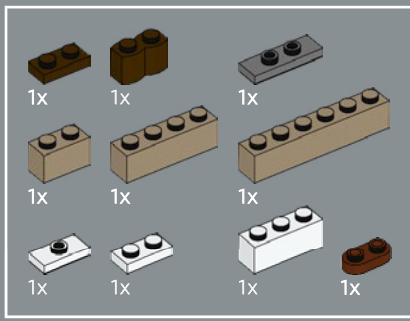

104

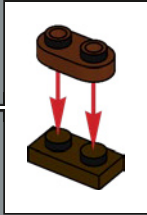
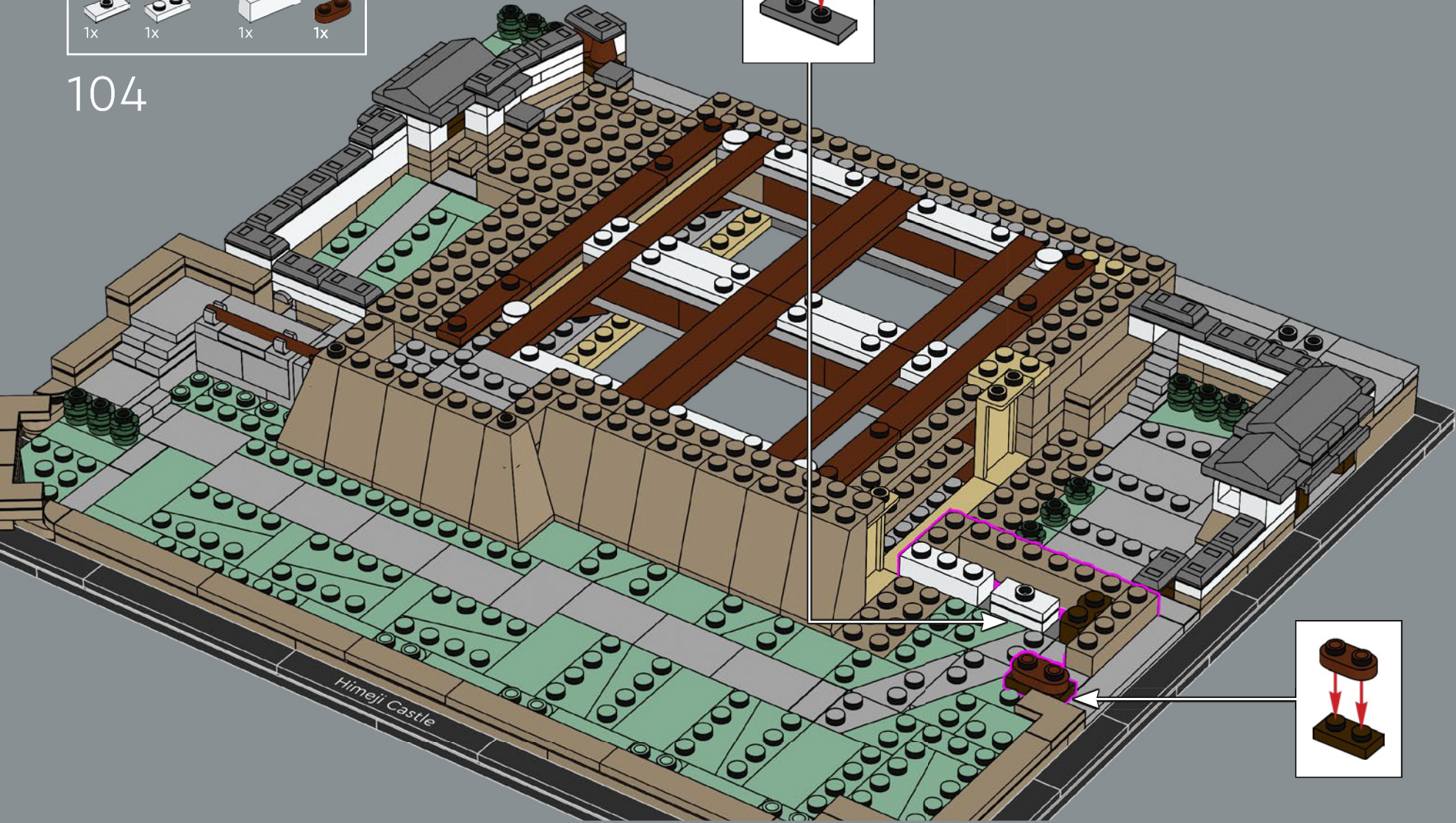



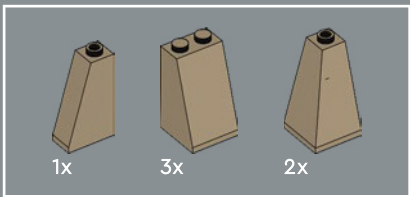

105

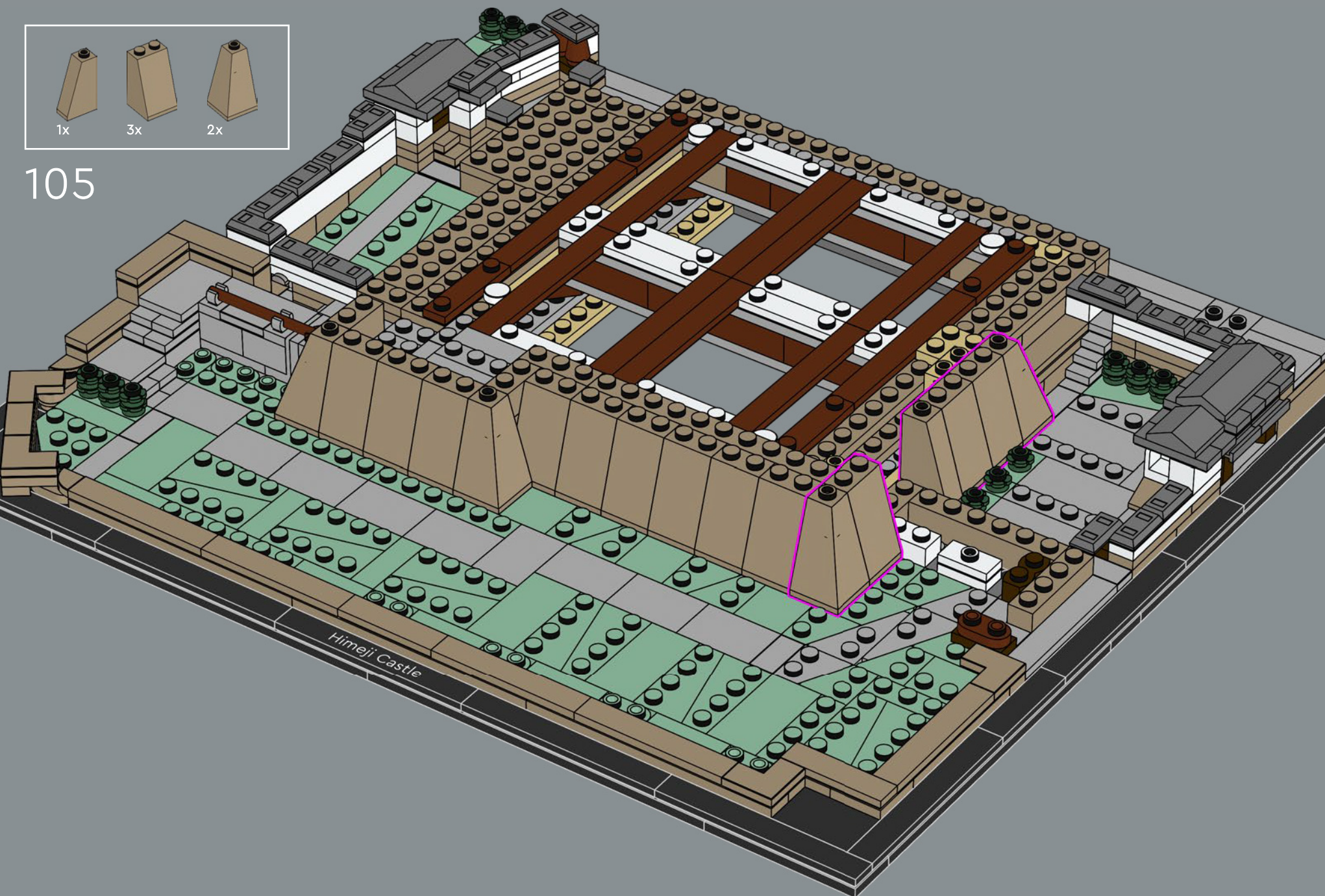



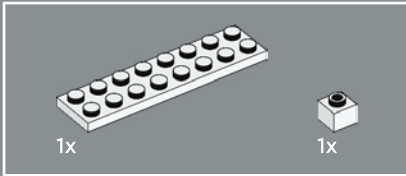
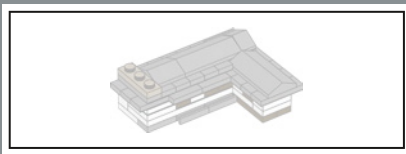

106

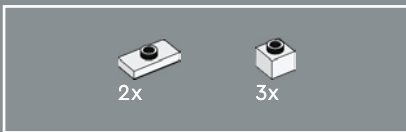
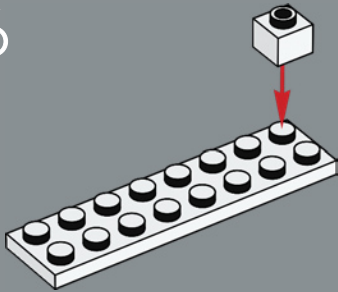

107

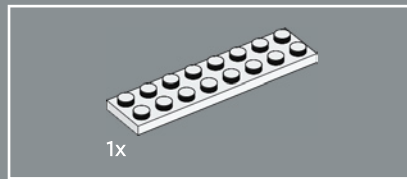
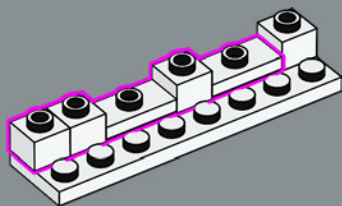

108

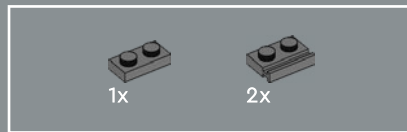
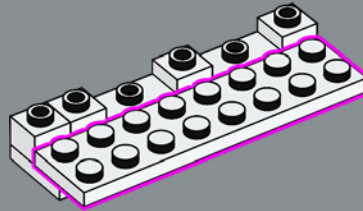

109

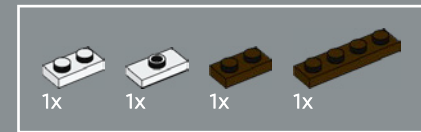
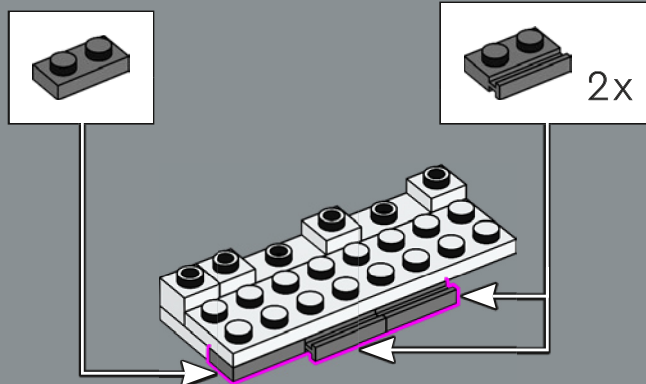

110

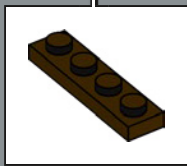
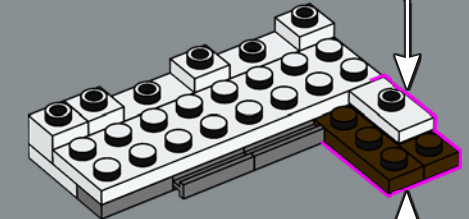
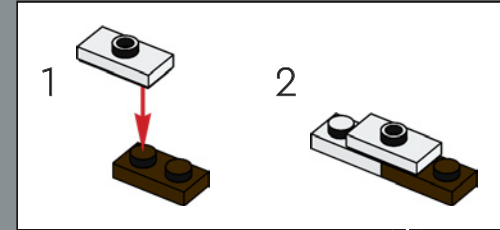

111

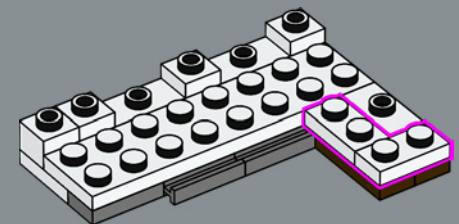

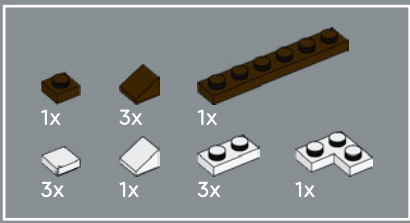

112

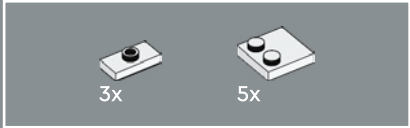
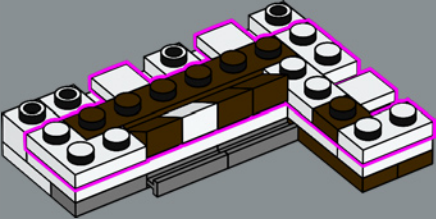

113

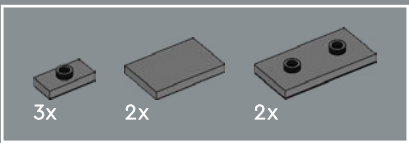
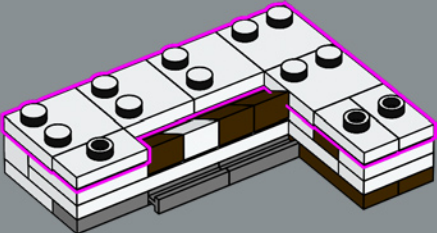

114

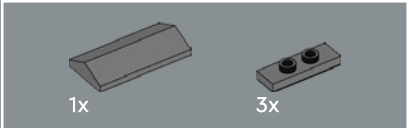
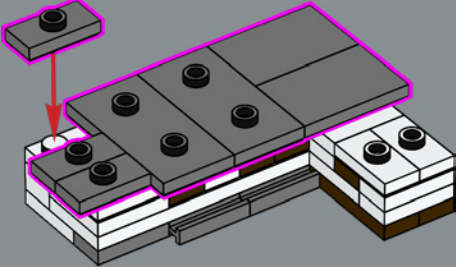

115

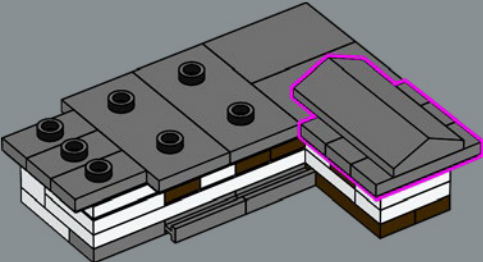
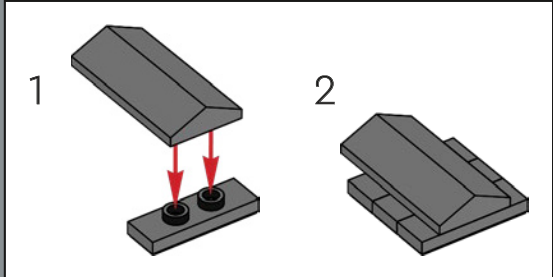



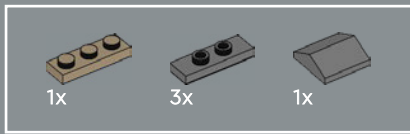

116

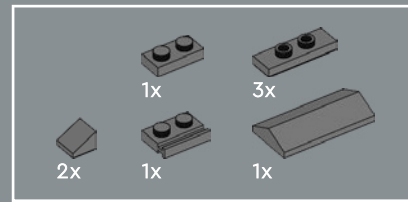
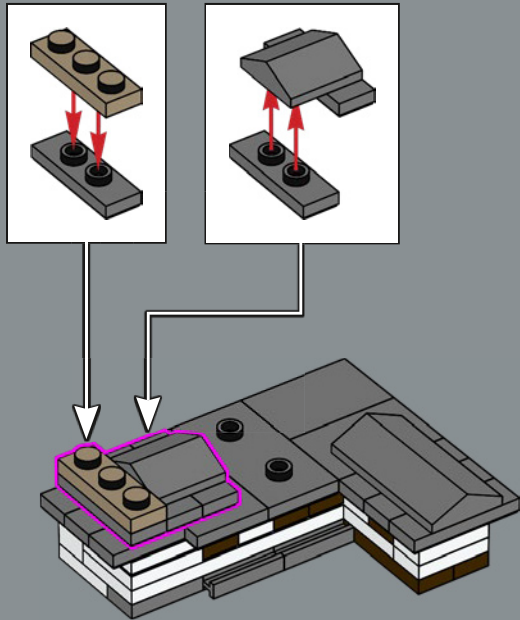

117

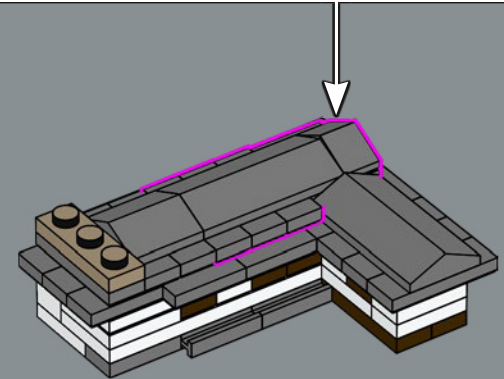
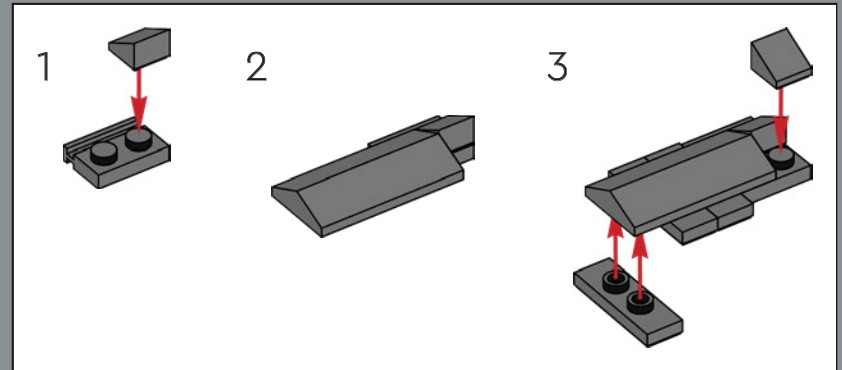

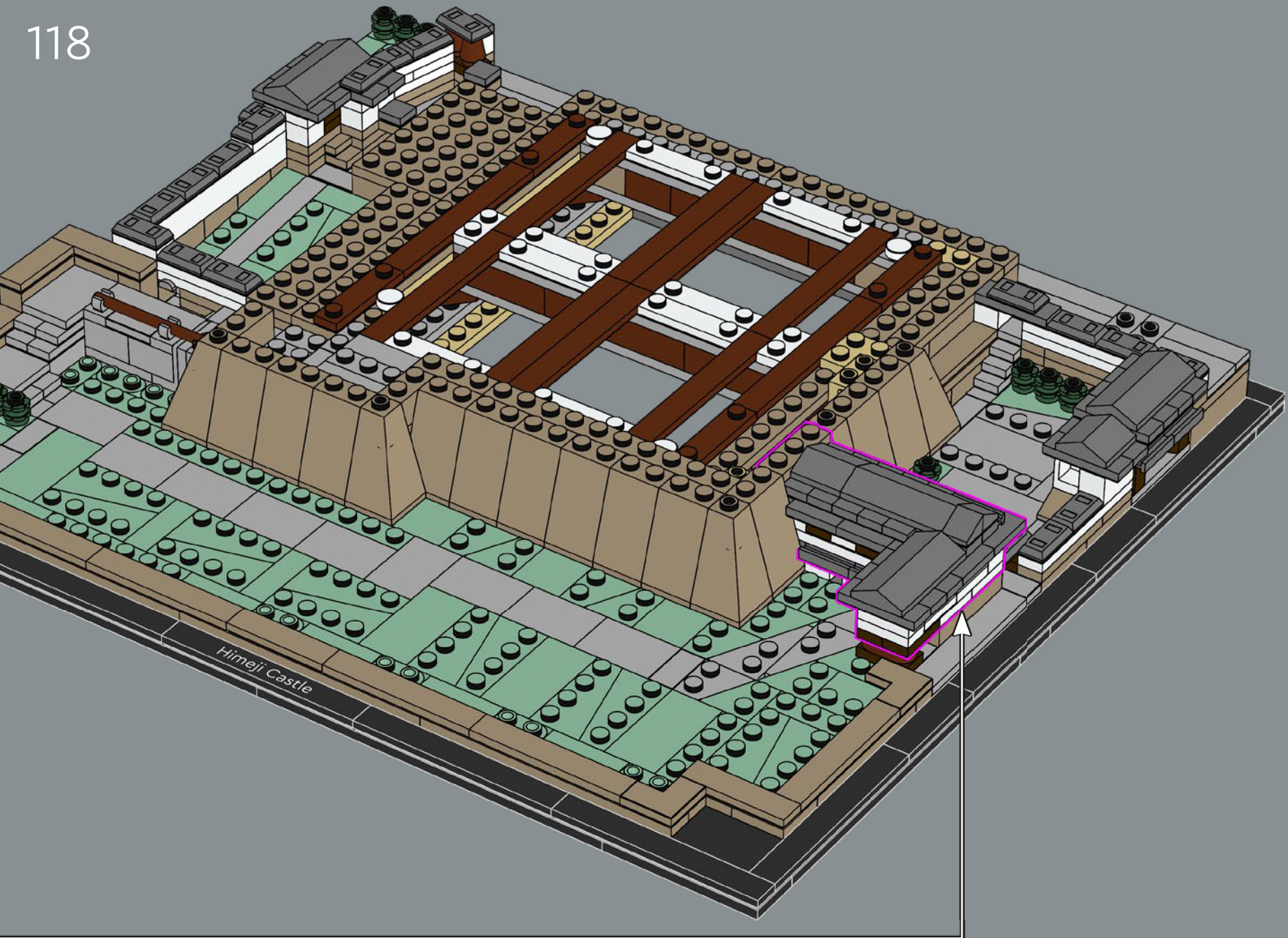



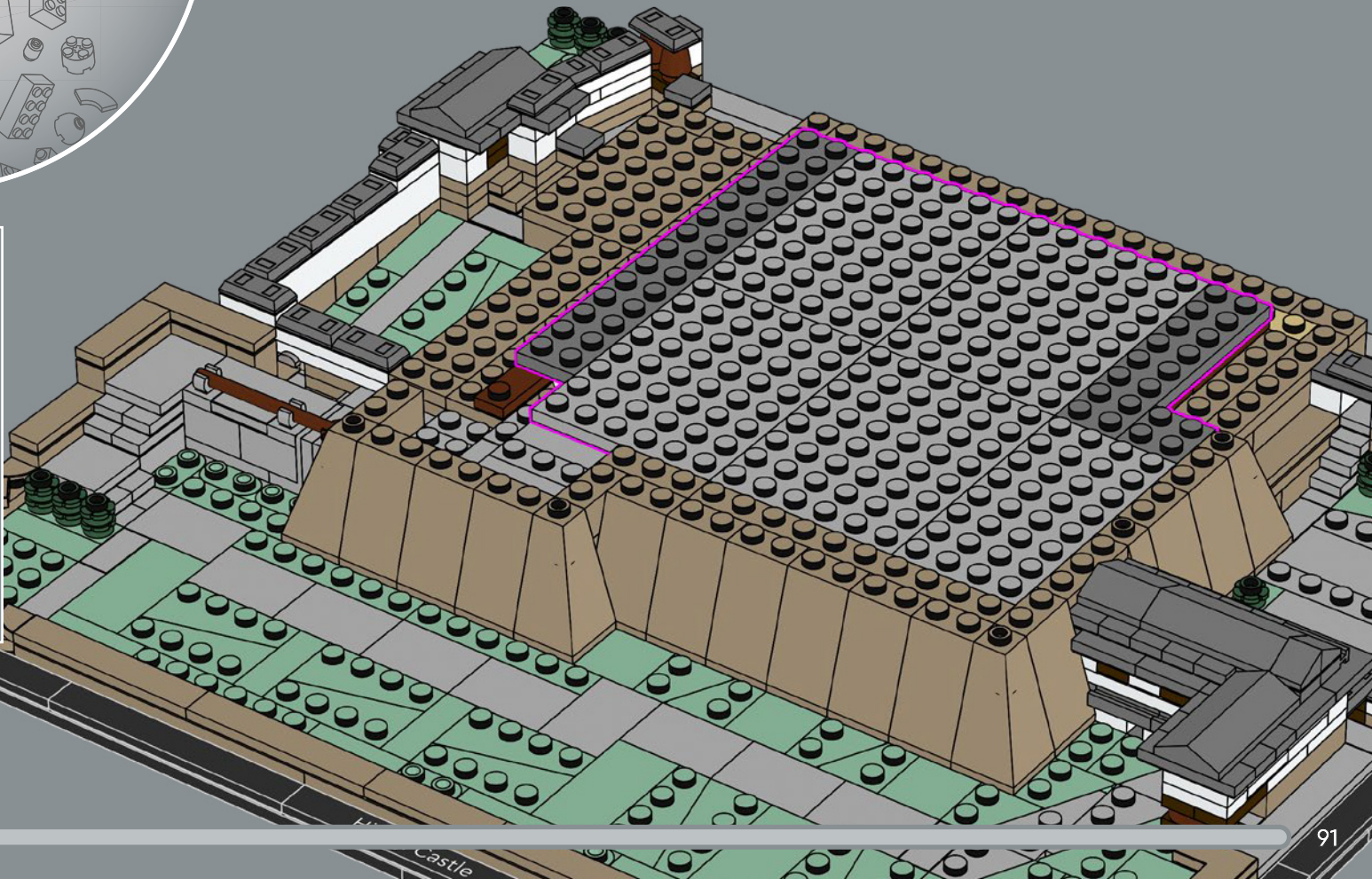
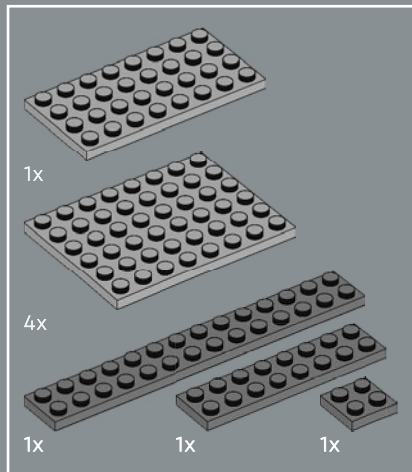

119



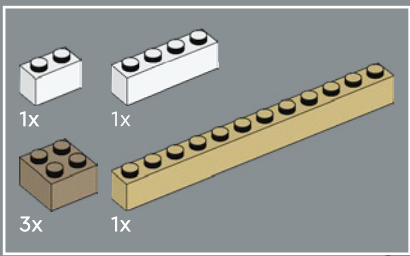

120

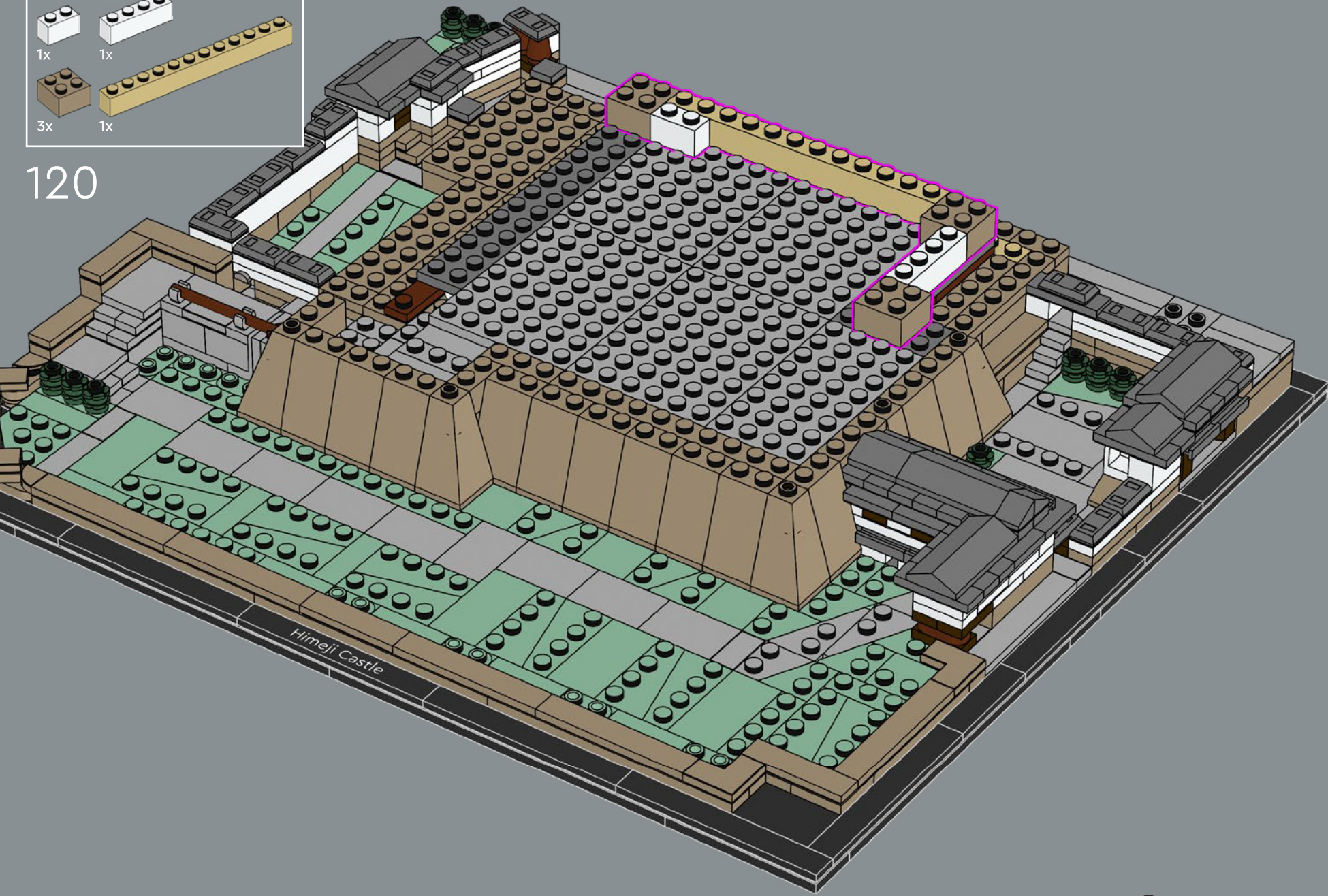



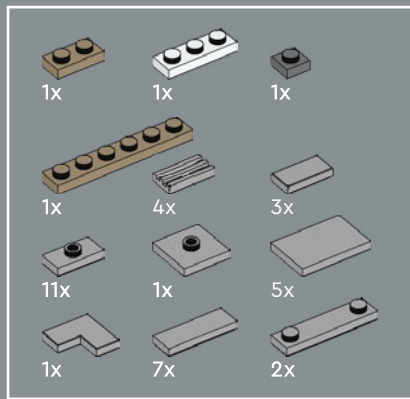

121

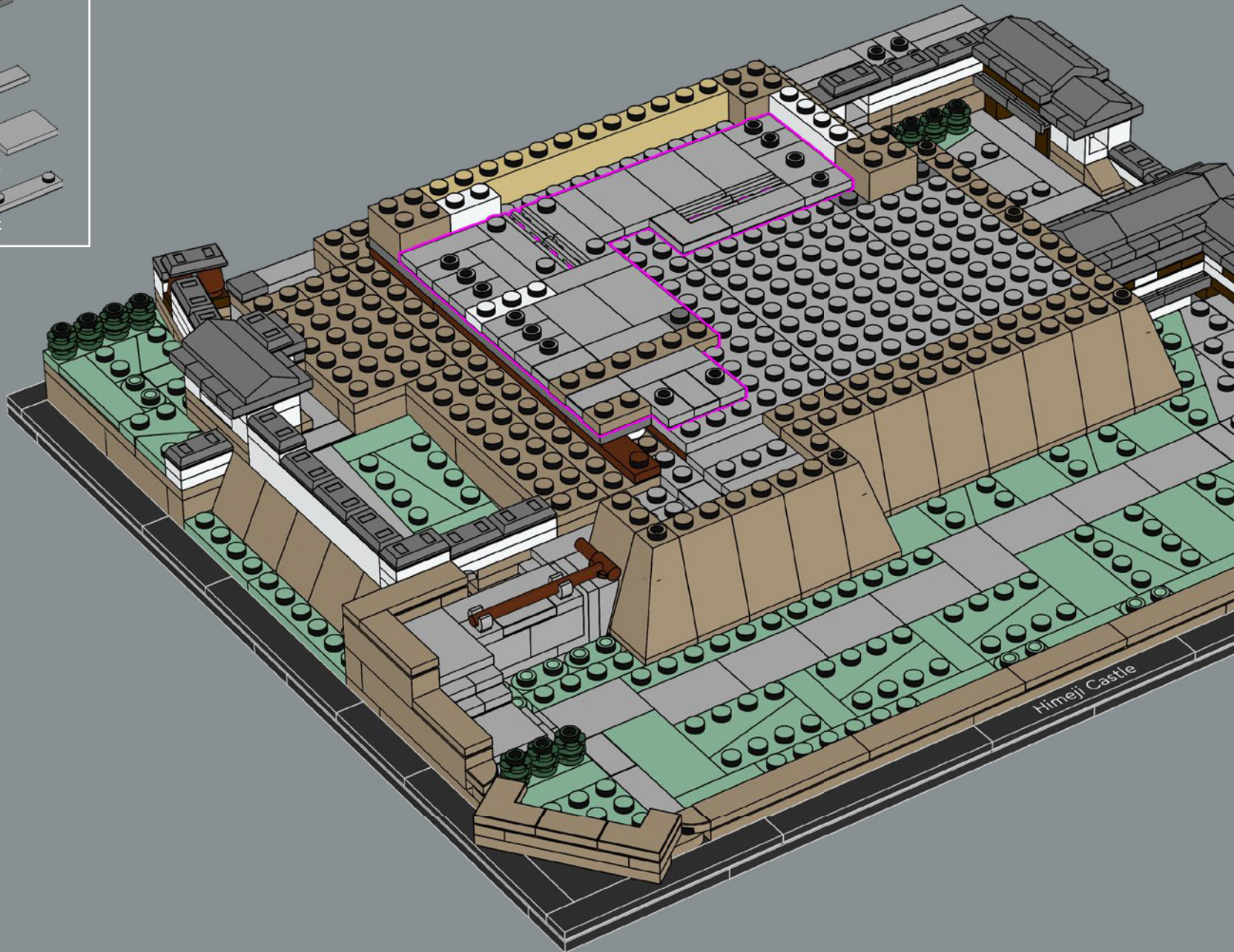

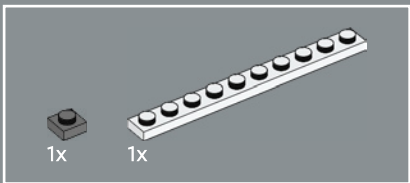

122

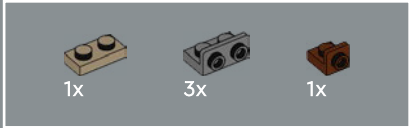
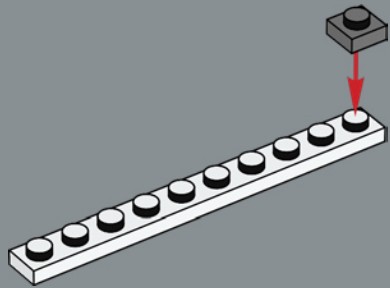

123

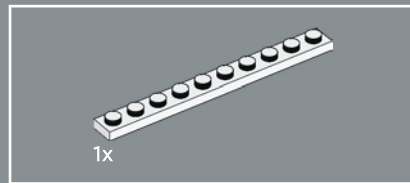
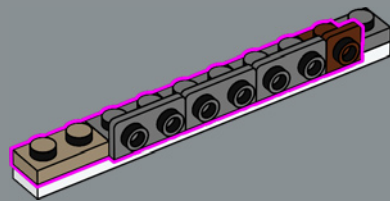

124

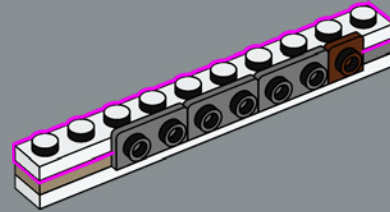

125

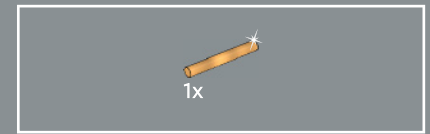
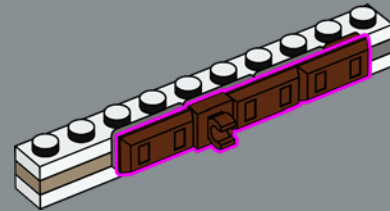

126

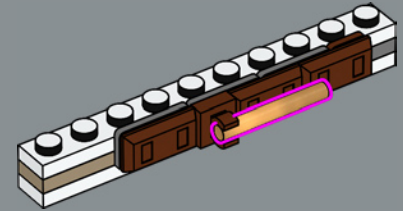



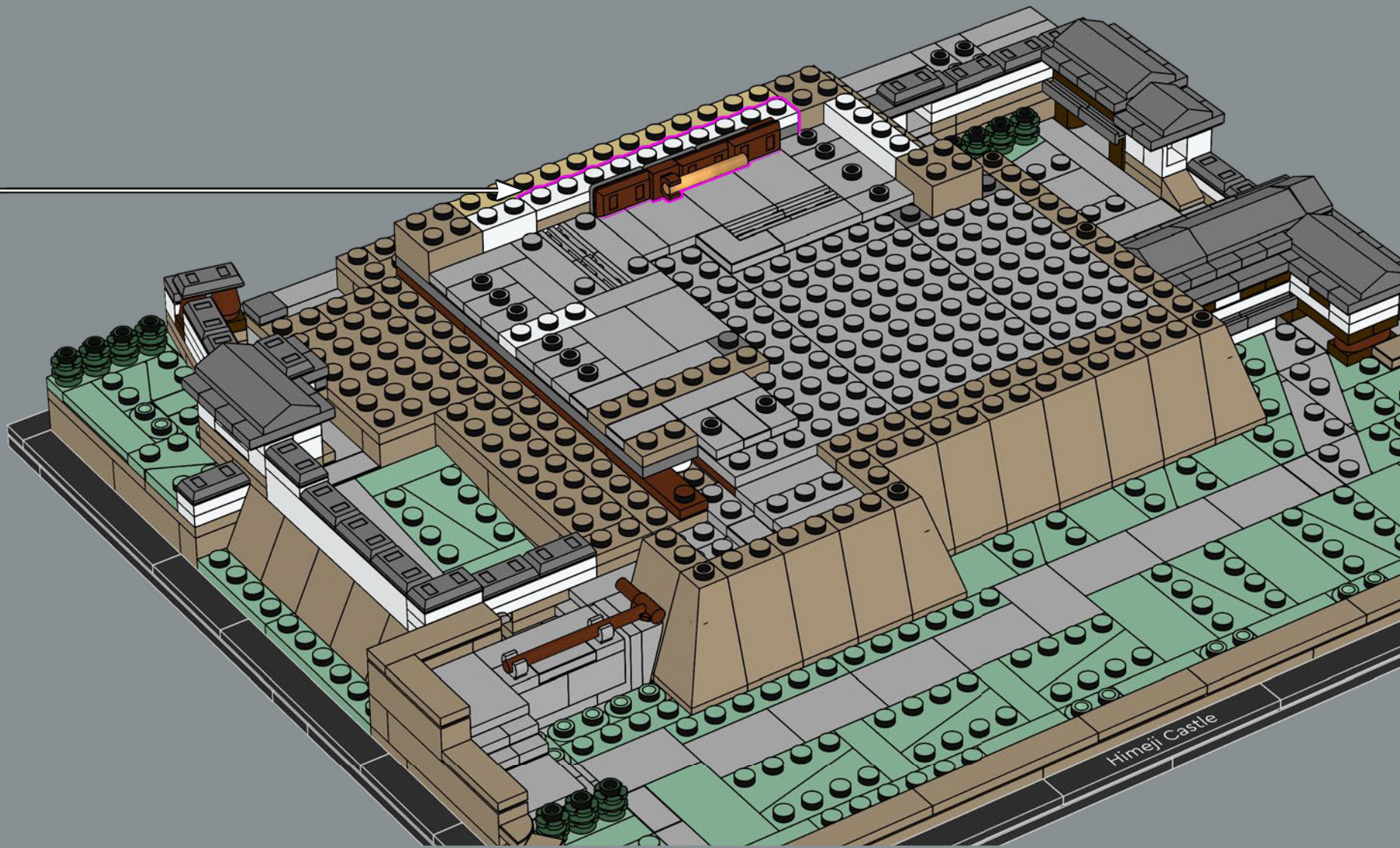



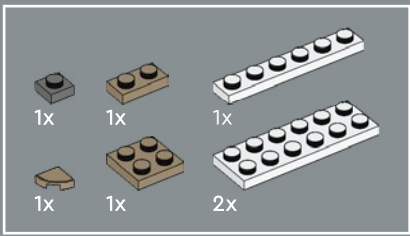

128

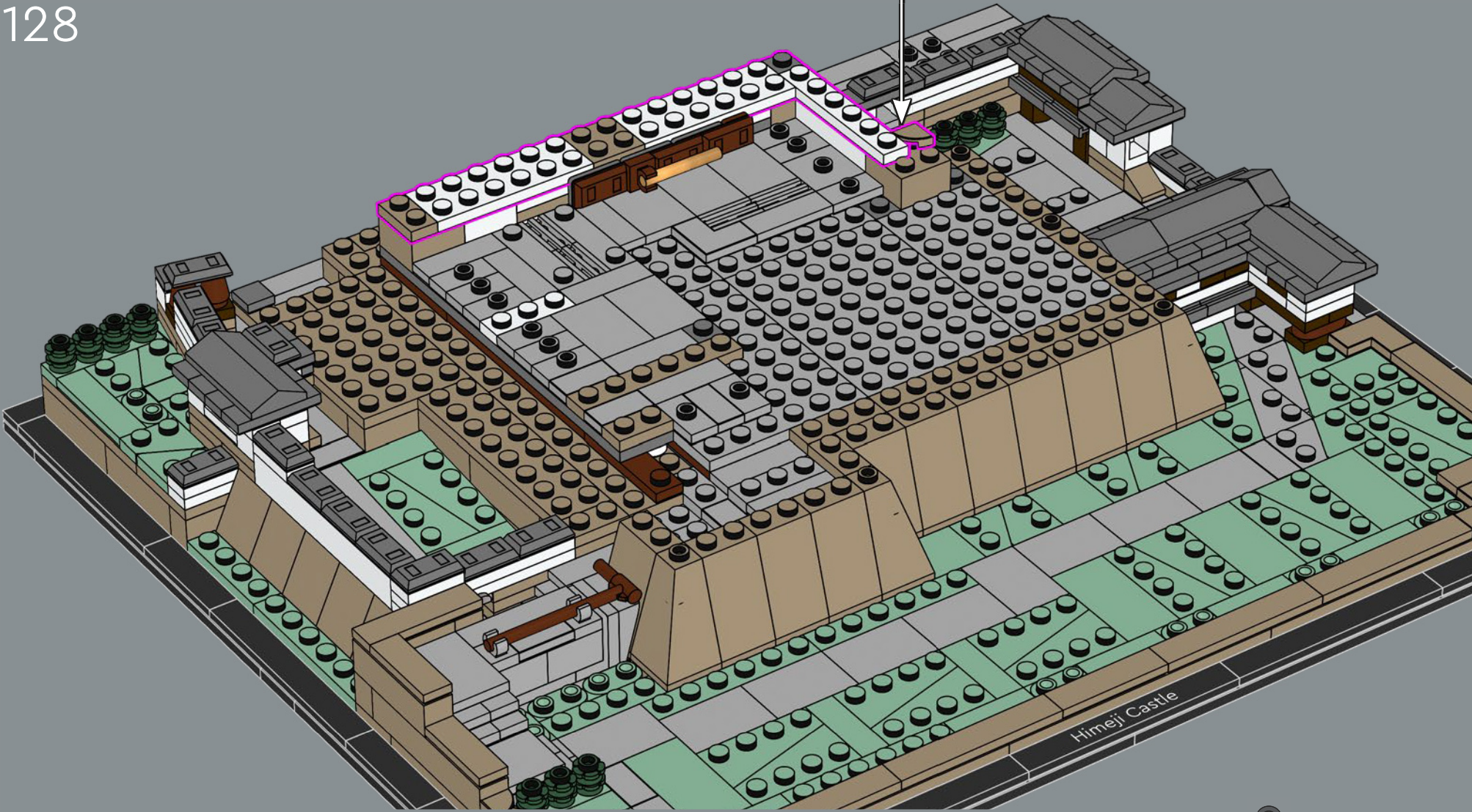



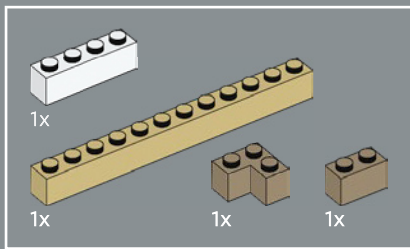

129

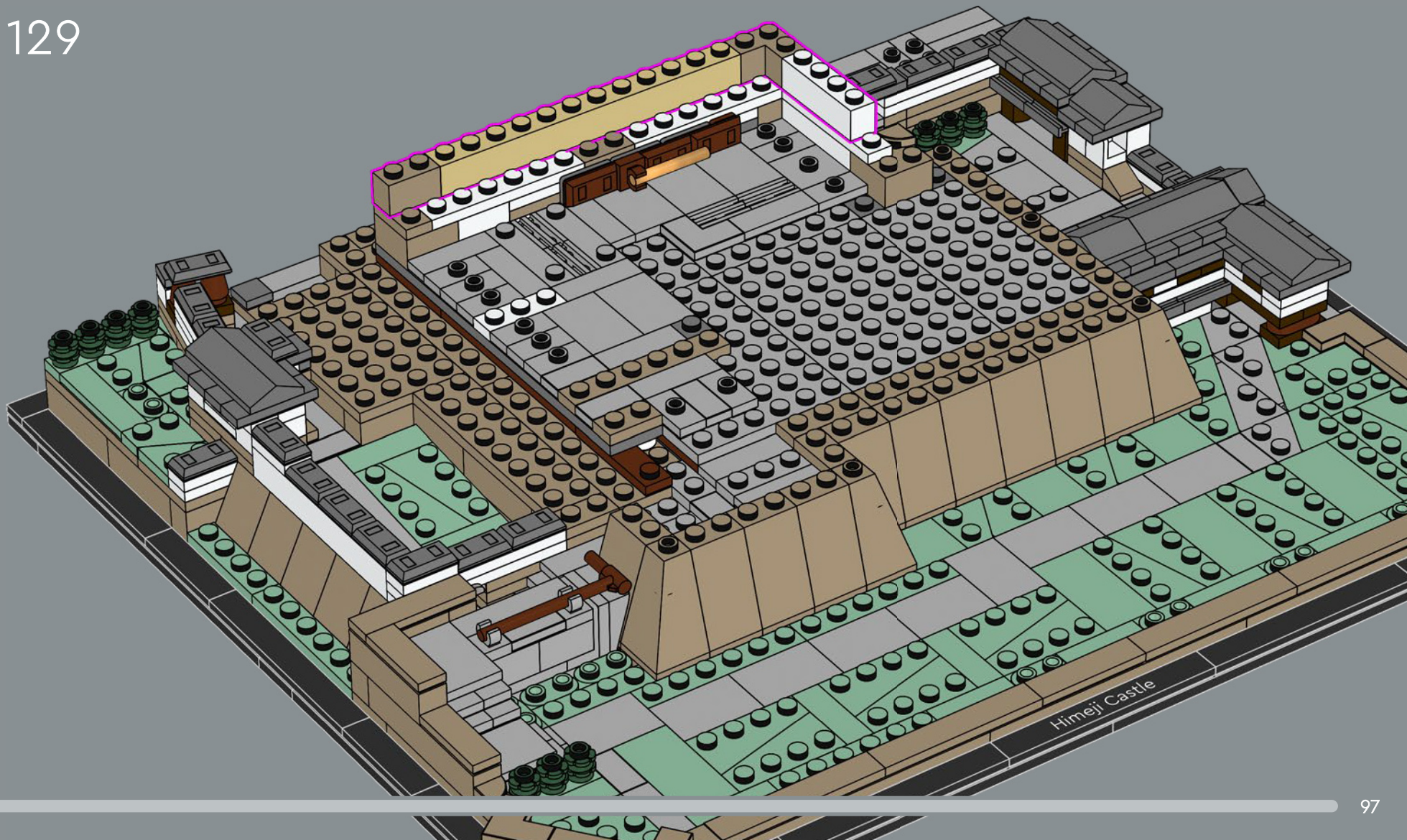



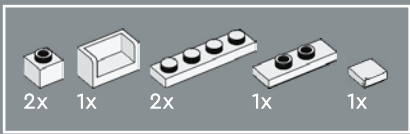

130

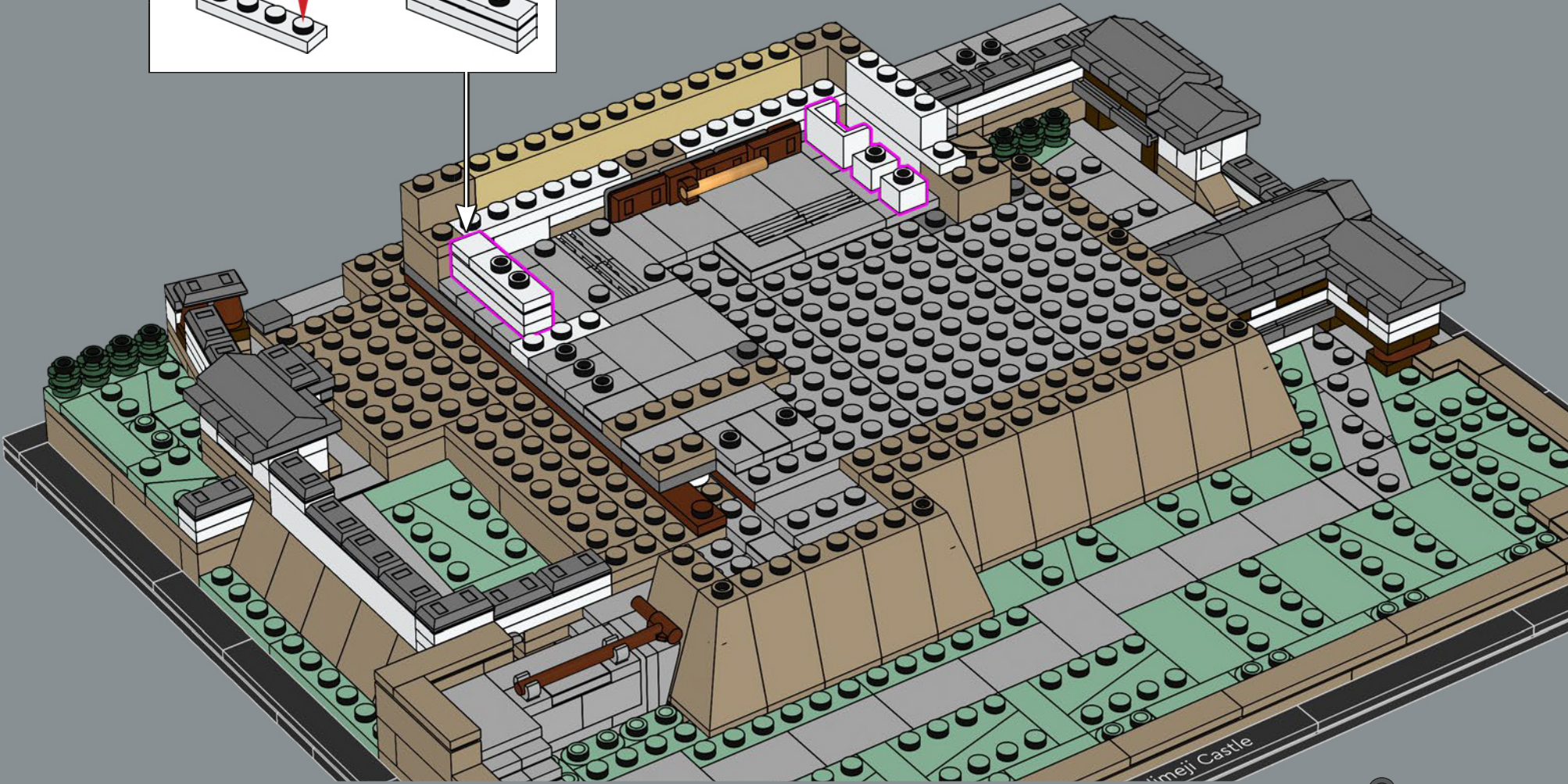
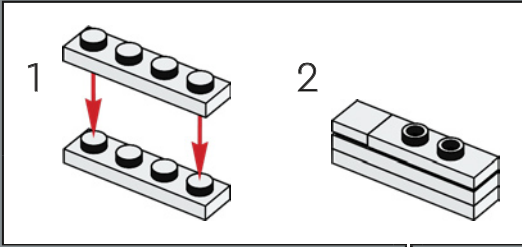



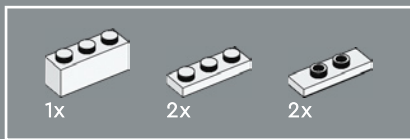

131

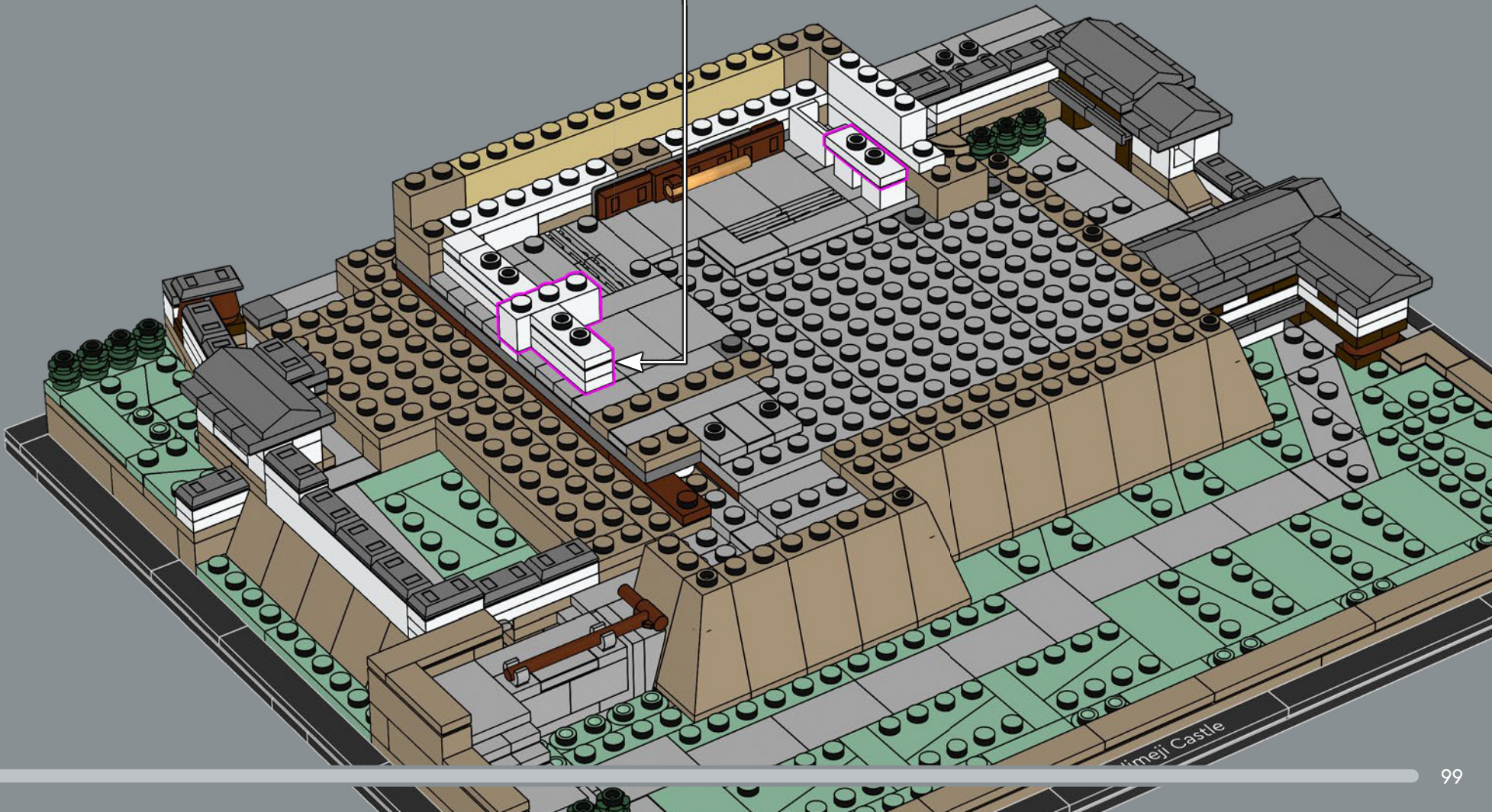
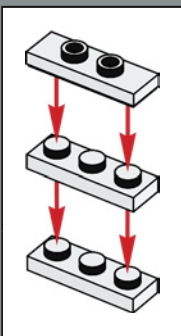



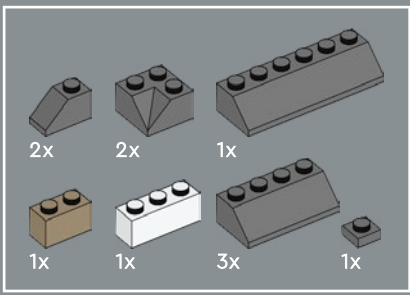

132

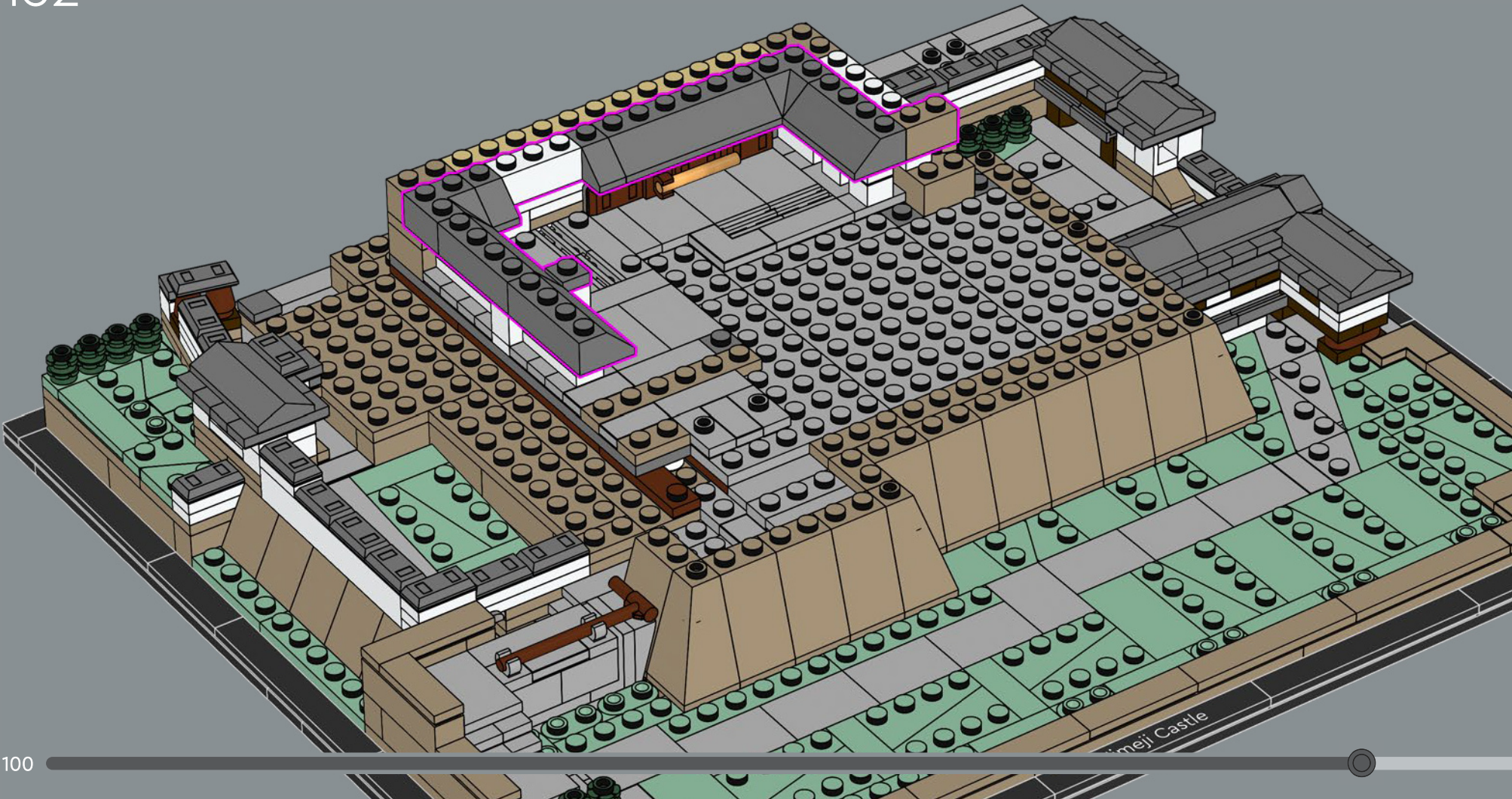



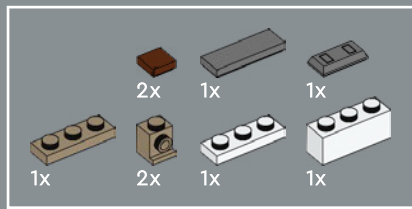

133

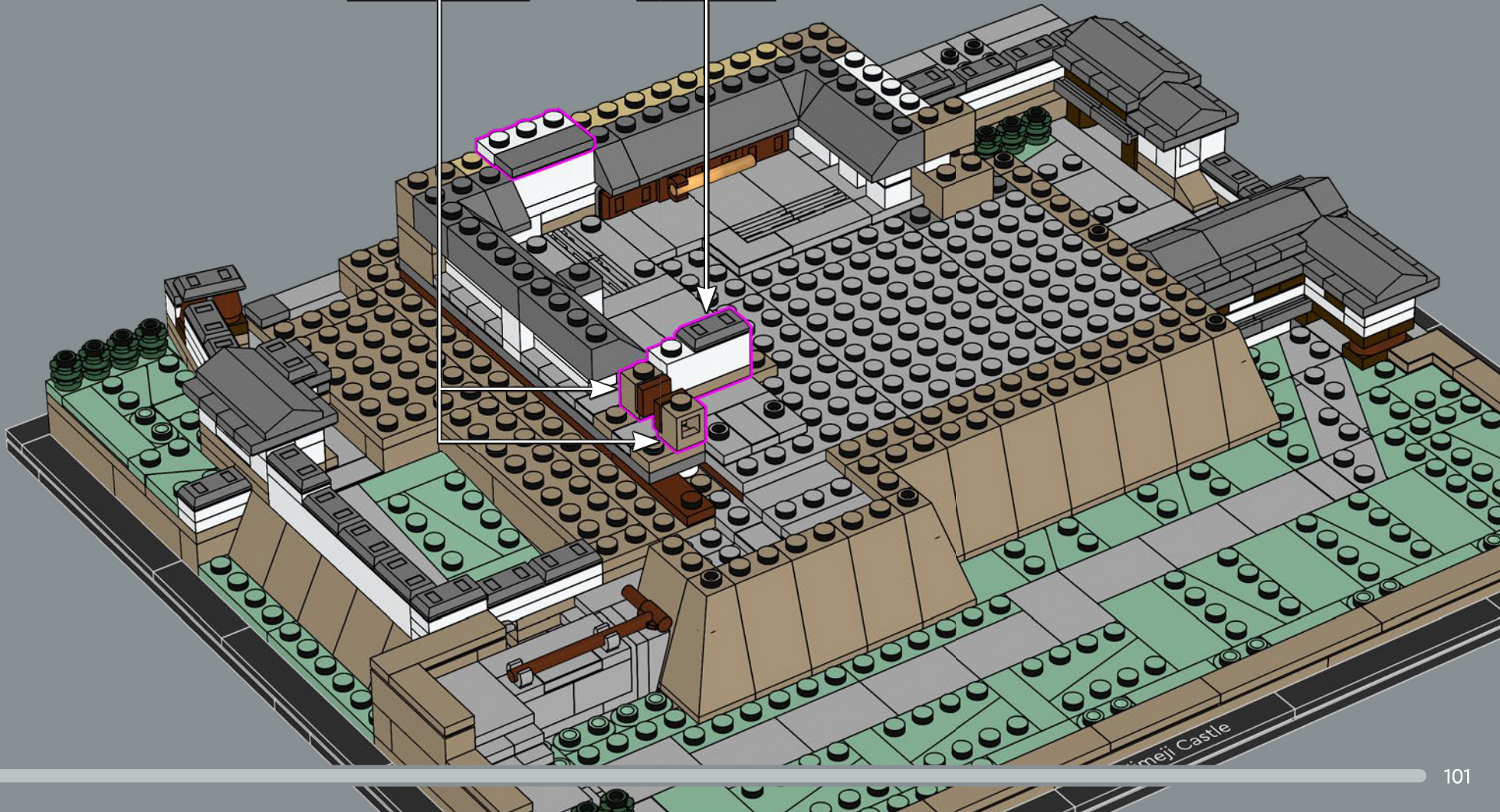
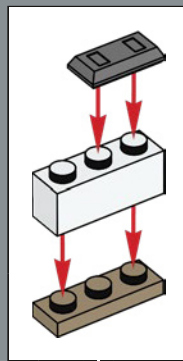
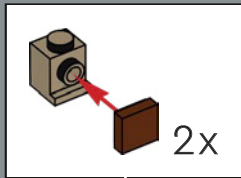

Meiji Castle



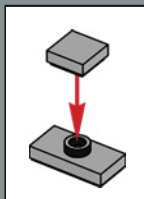
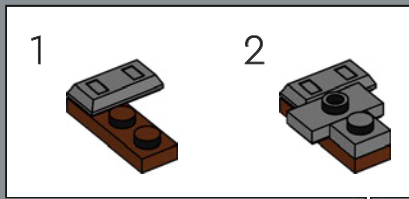
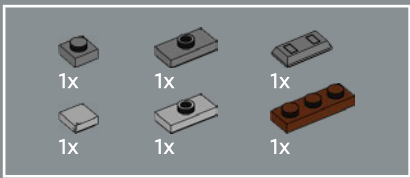

134

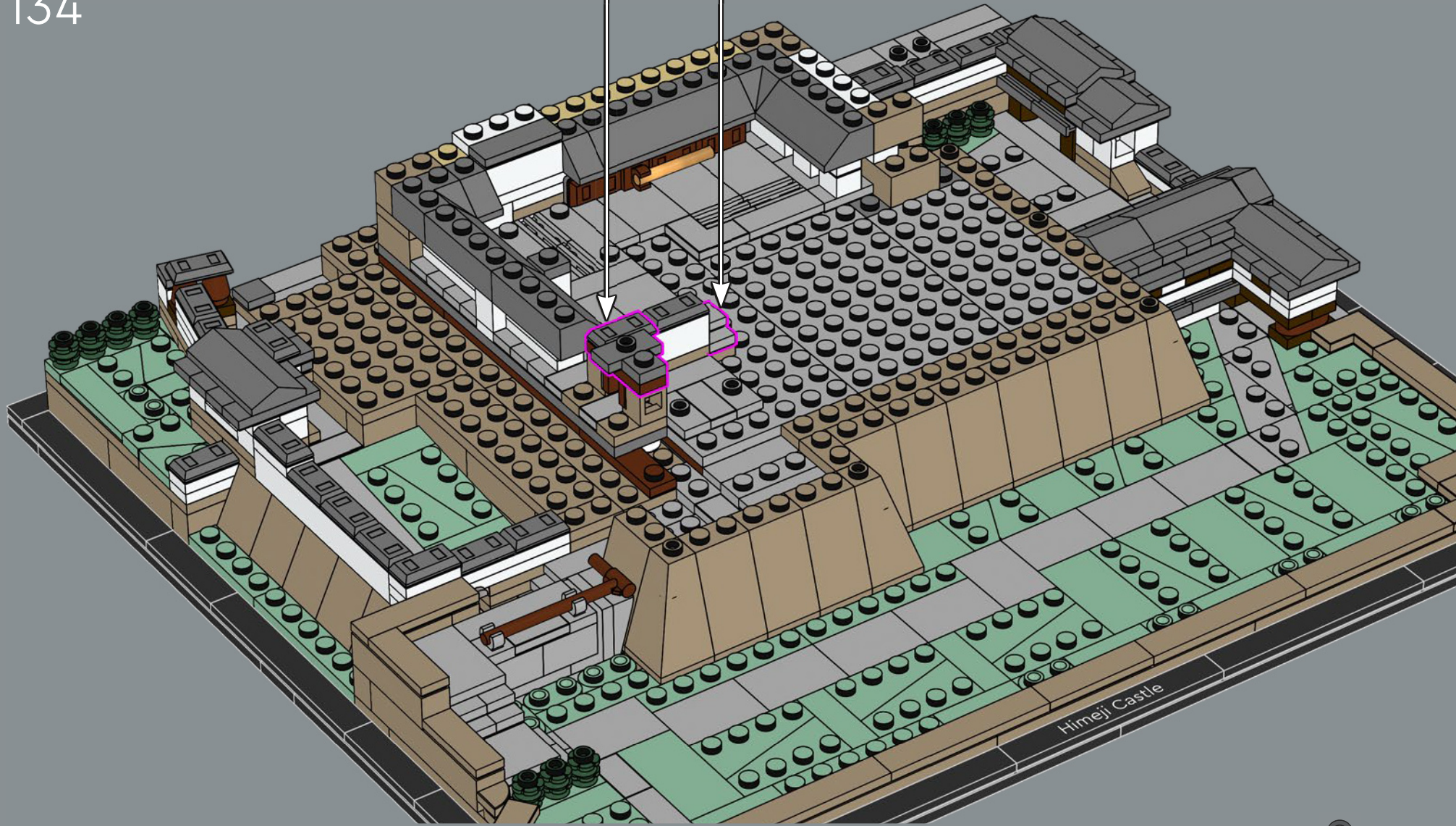



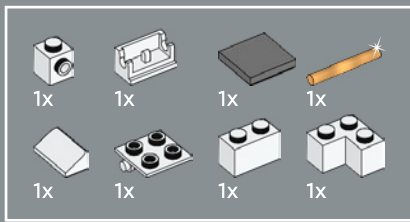

135

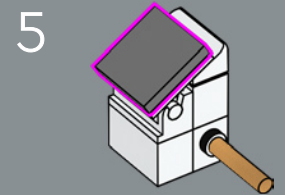
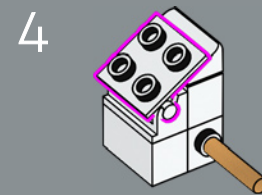
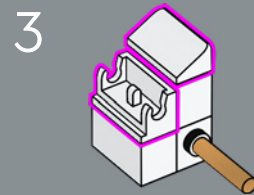
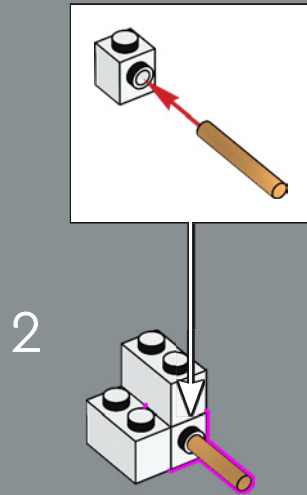
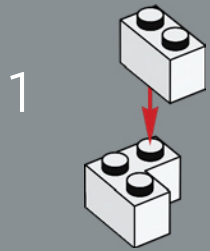

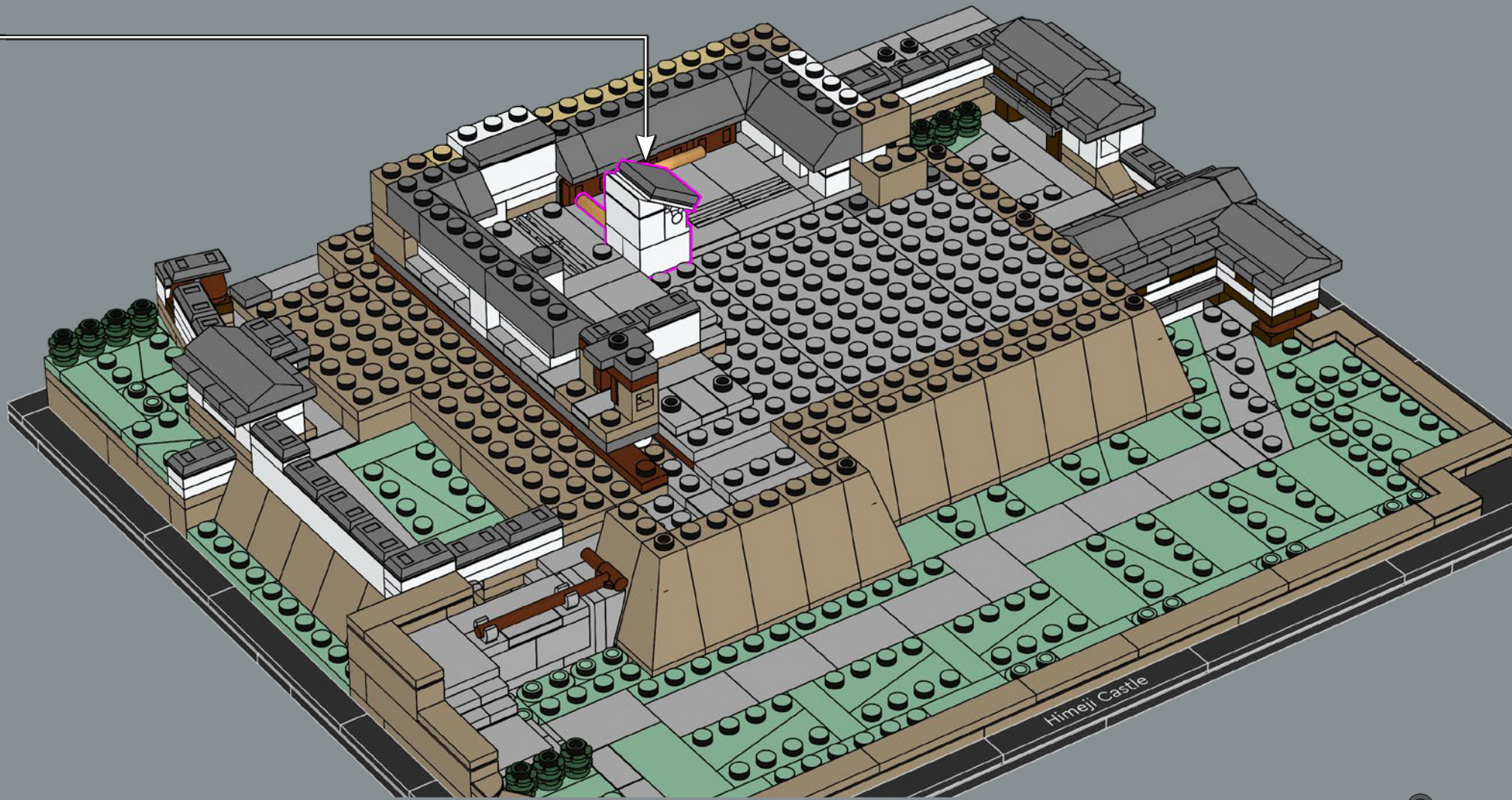



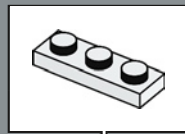
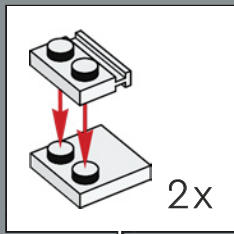
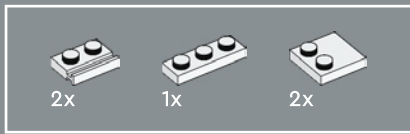

136





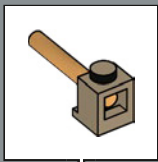
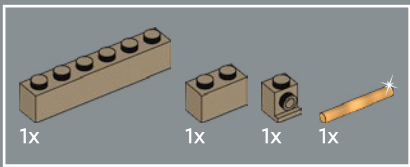

137

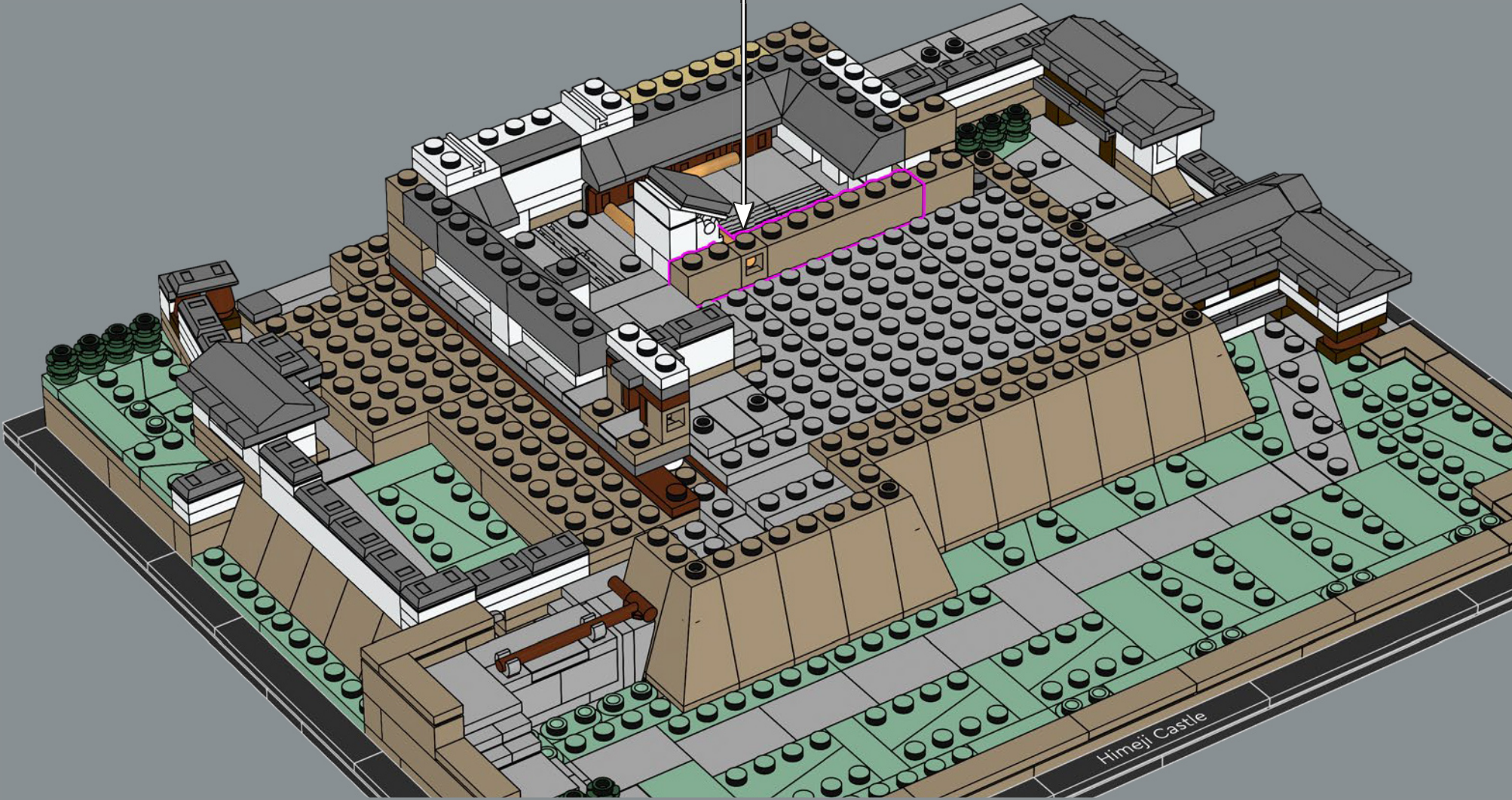

Himeji Castle



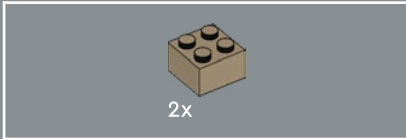
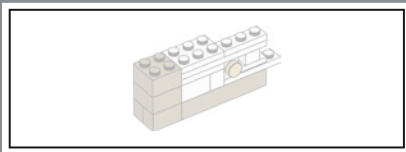

138

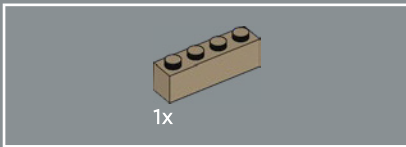
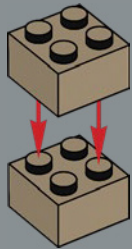

139

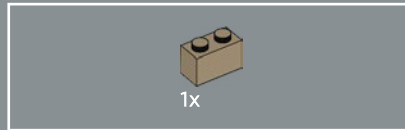
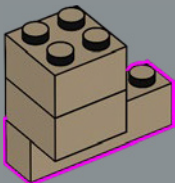

140

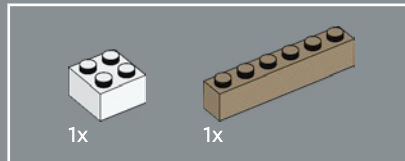
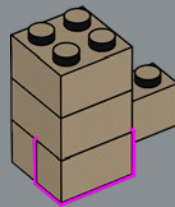

141

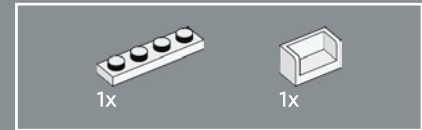
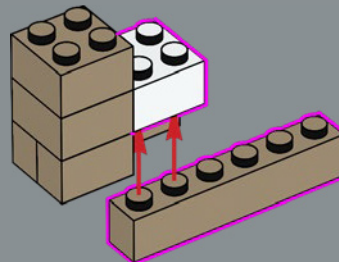

142

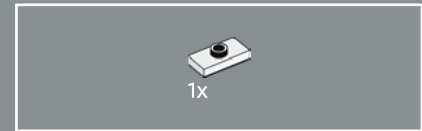
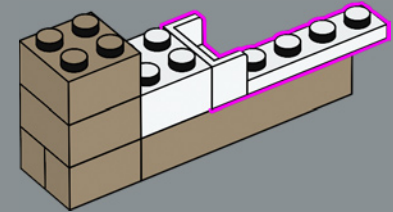

143

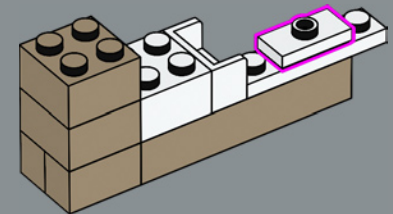

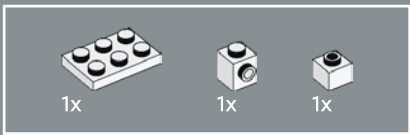

144

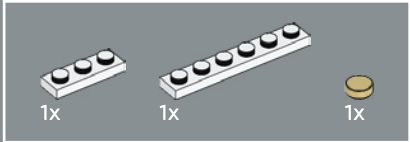
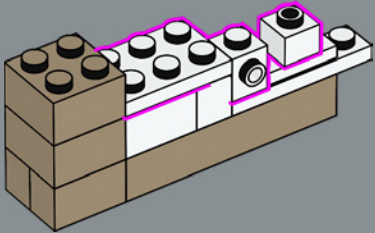

145

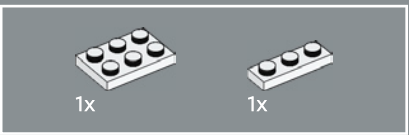
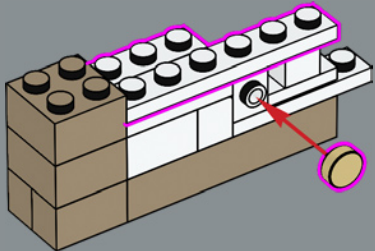

146

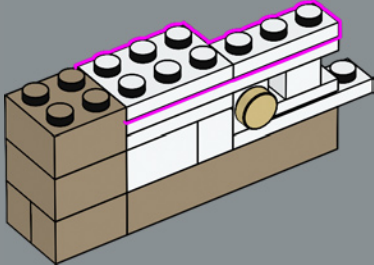



147

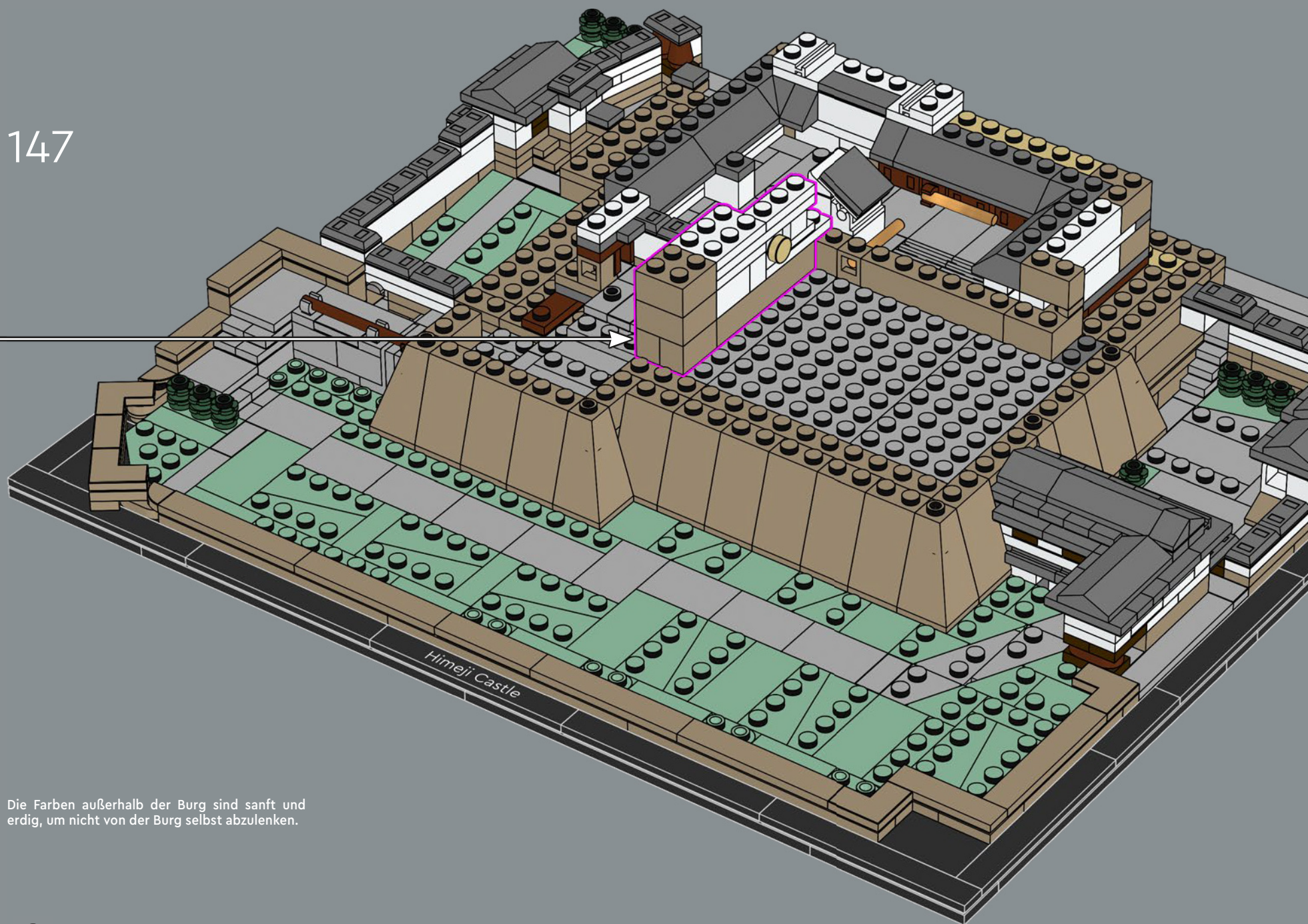

Die Farben außerhalb der Burg sind sanft und erdig, um nicht von der Burg selbst abzulenken.

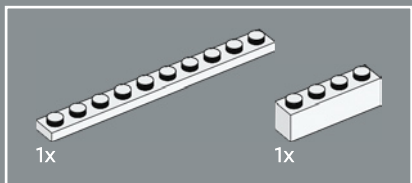

148

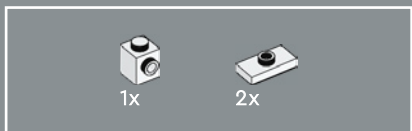
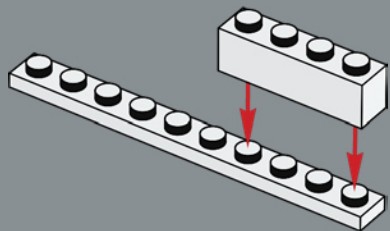

149

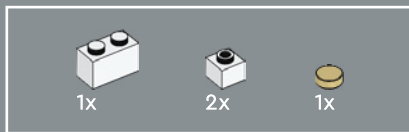
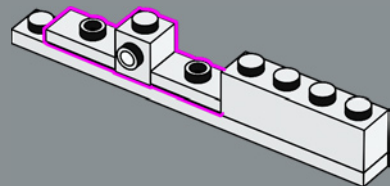

150

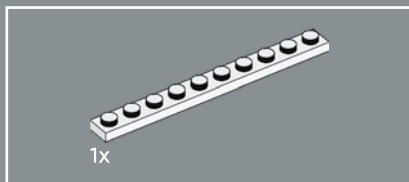
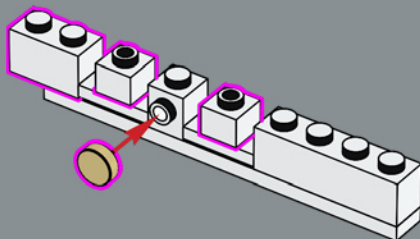

151

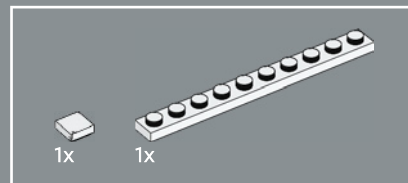
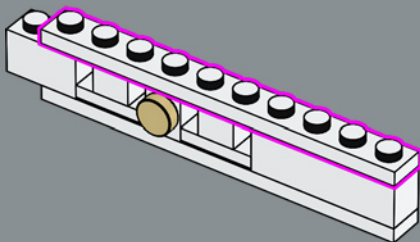

152

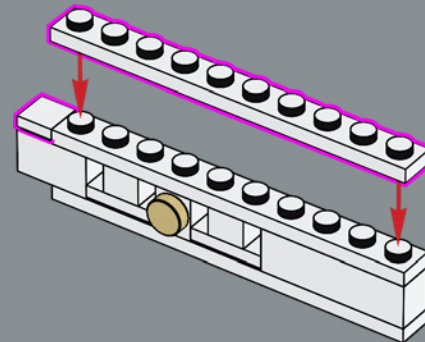



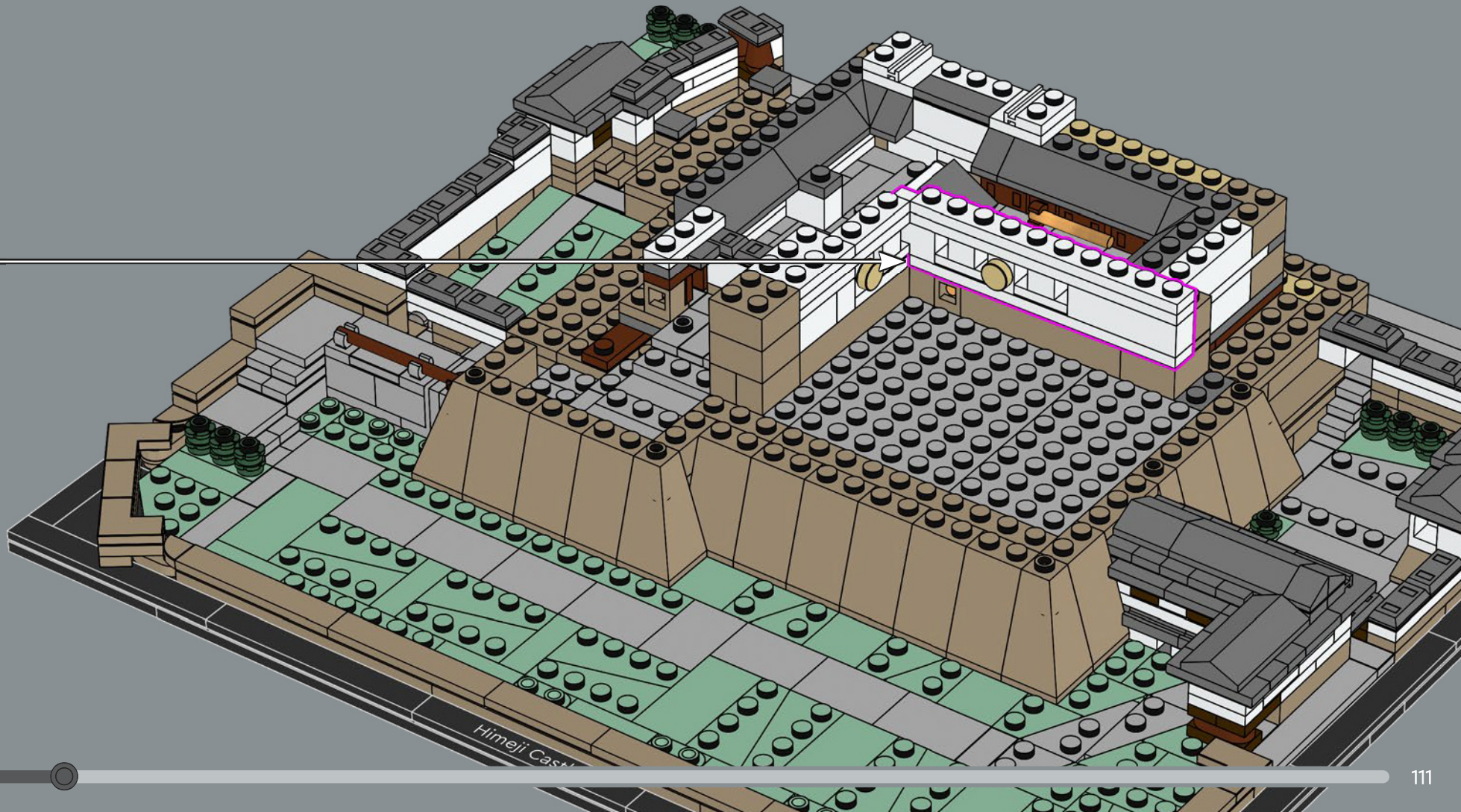



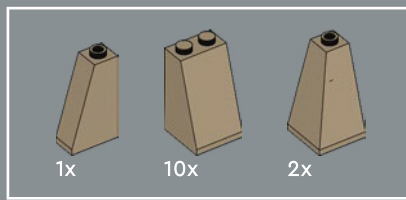

154

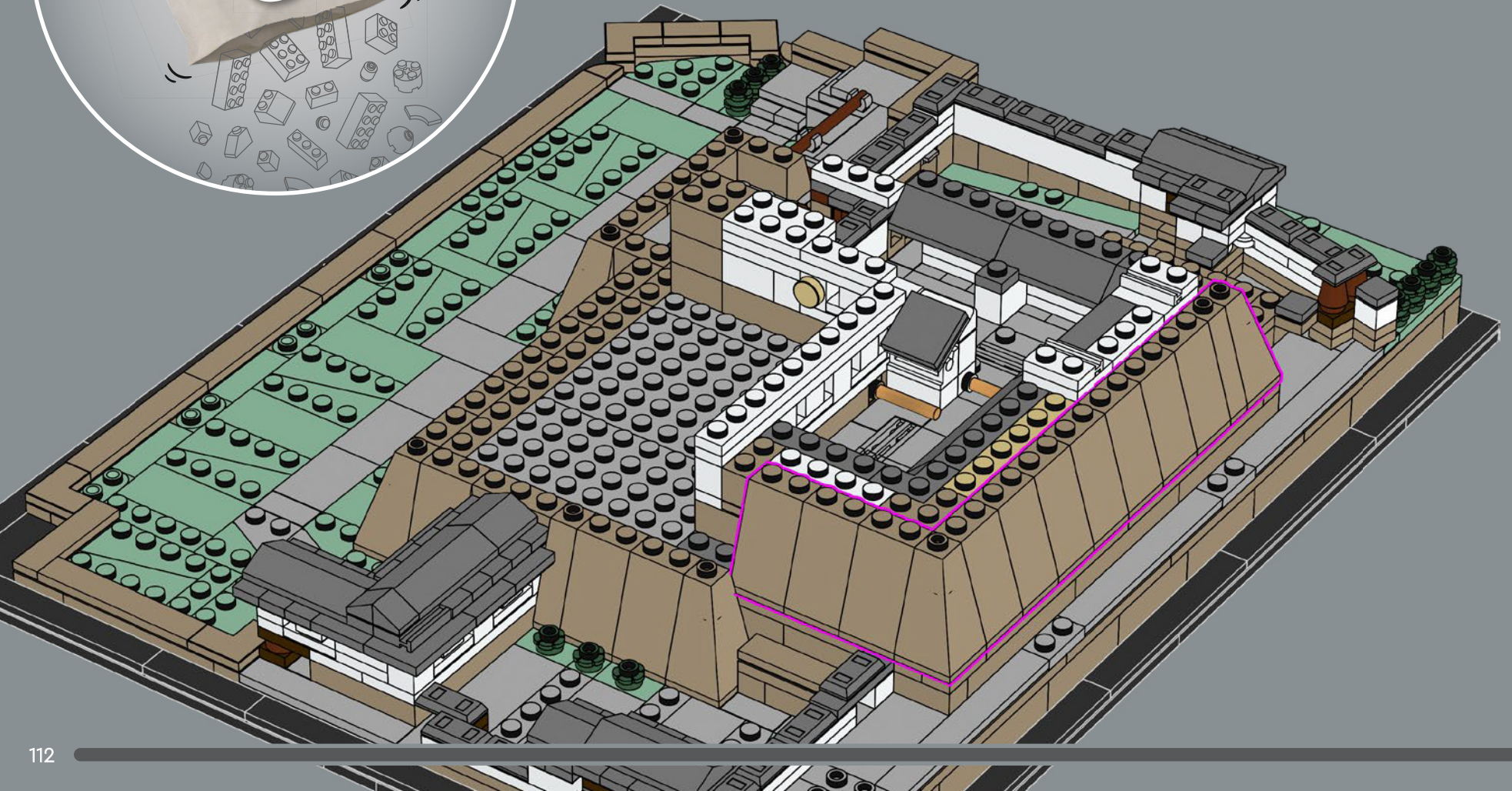



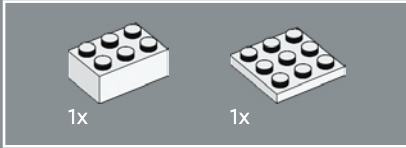

155

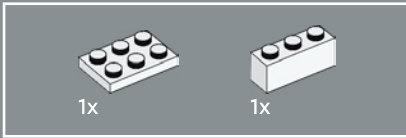
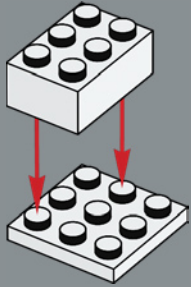

156

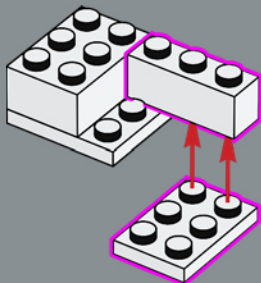

157

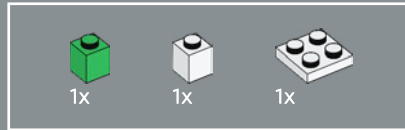
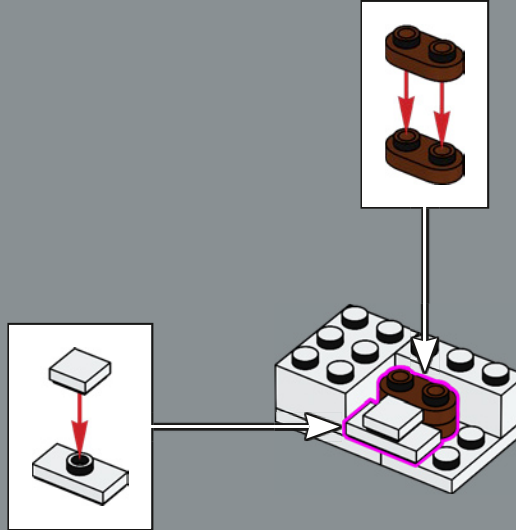

158

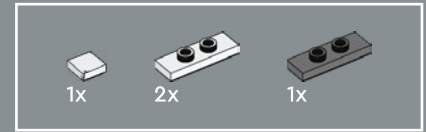
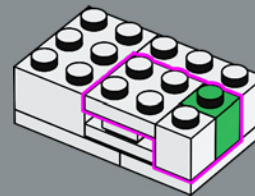

159

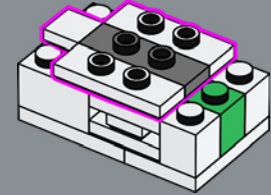

160

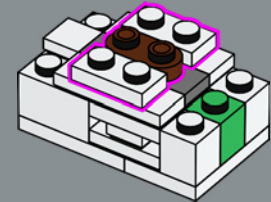

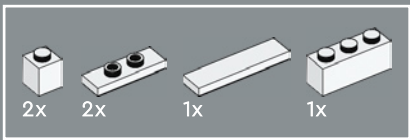

161

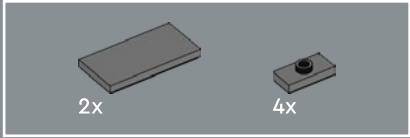
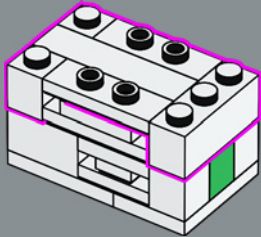

162

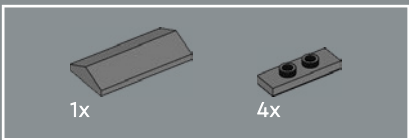
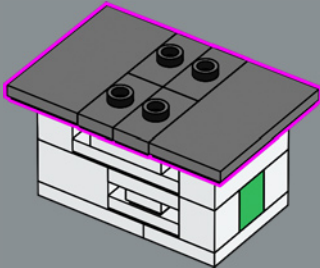

163

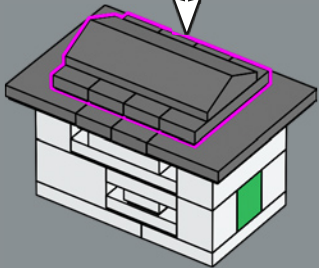
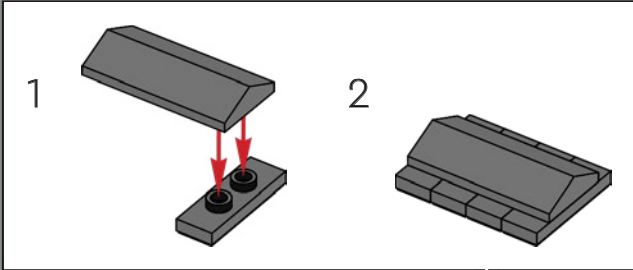



164

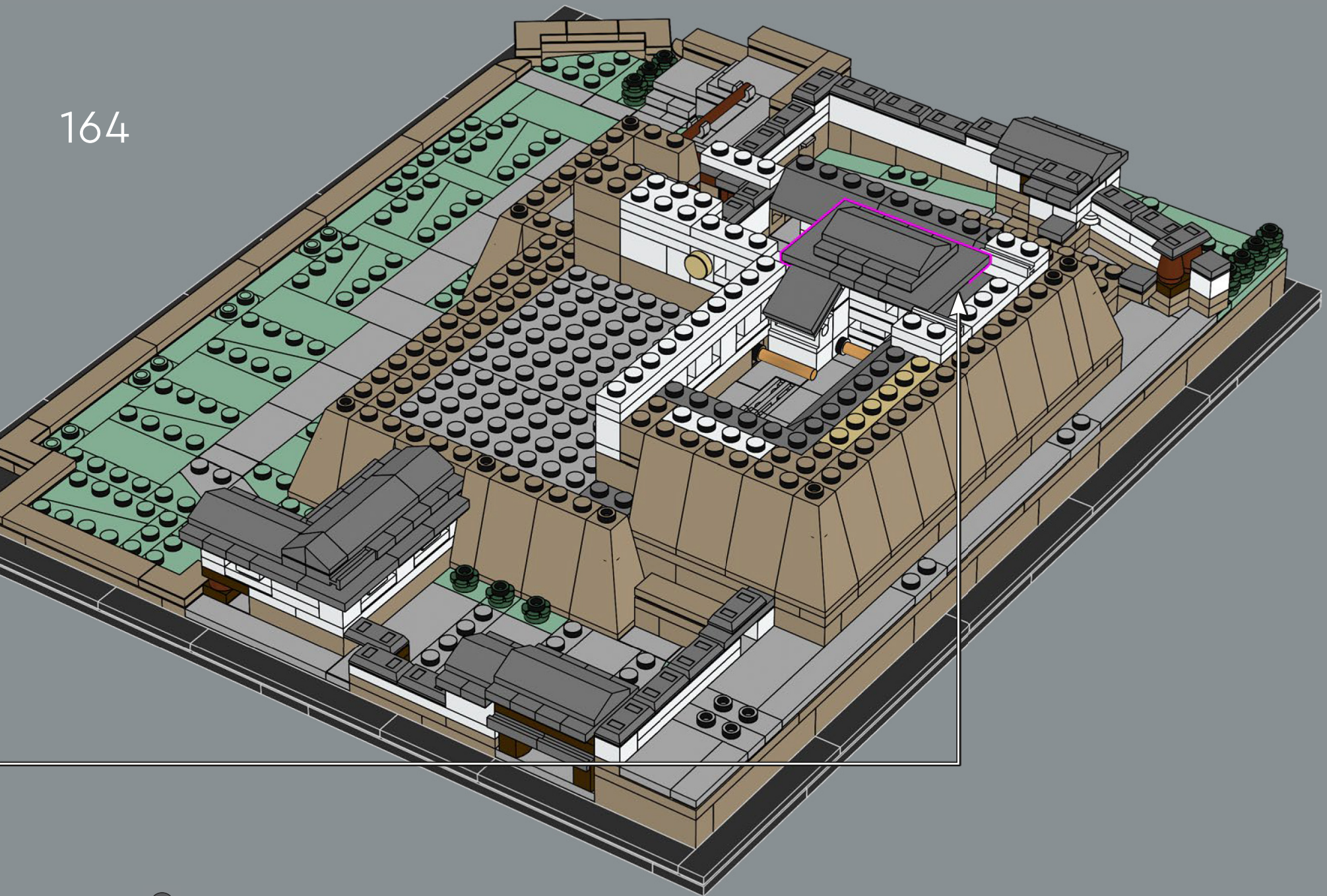

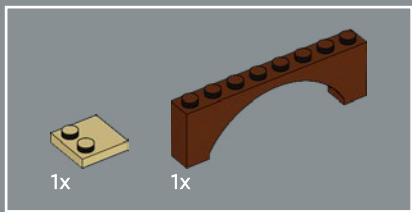

165

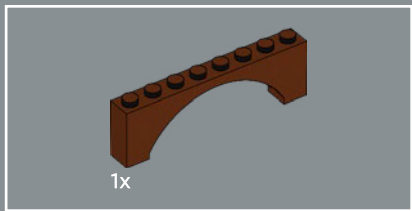
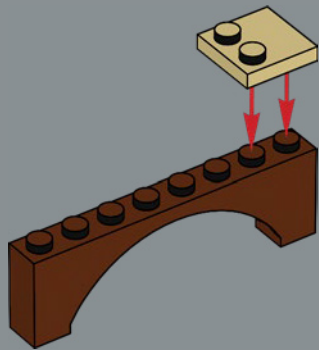

166

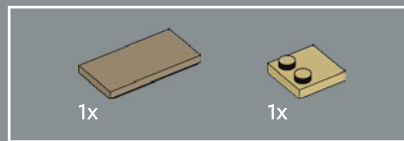
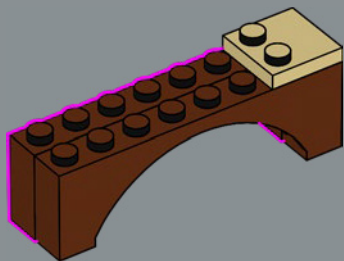

167

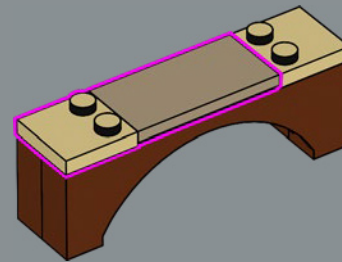

168

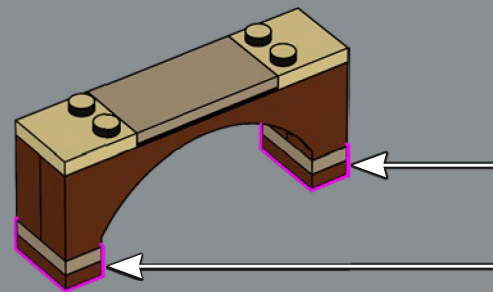
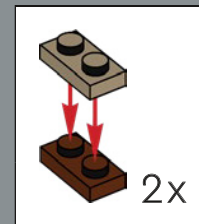



169

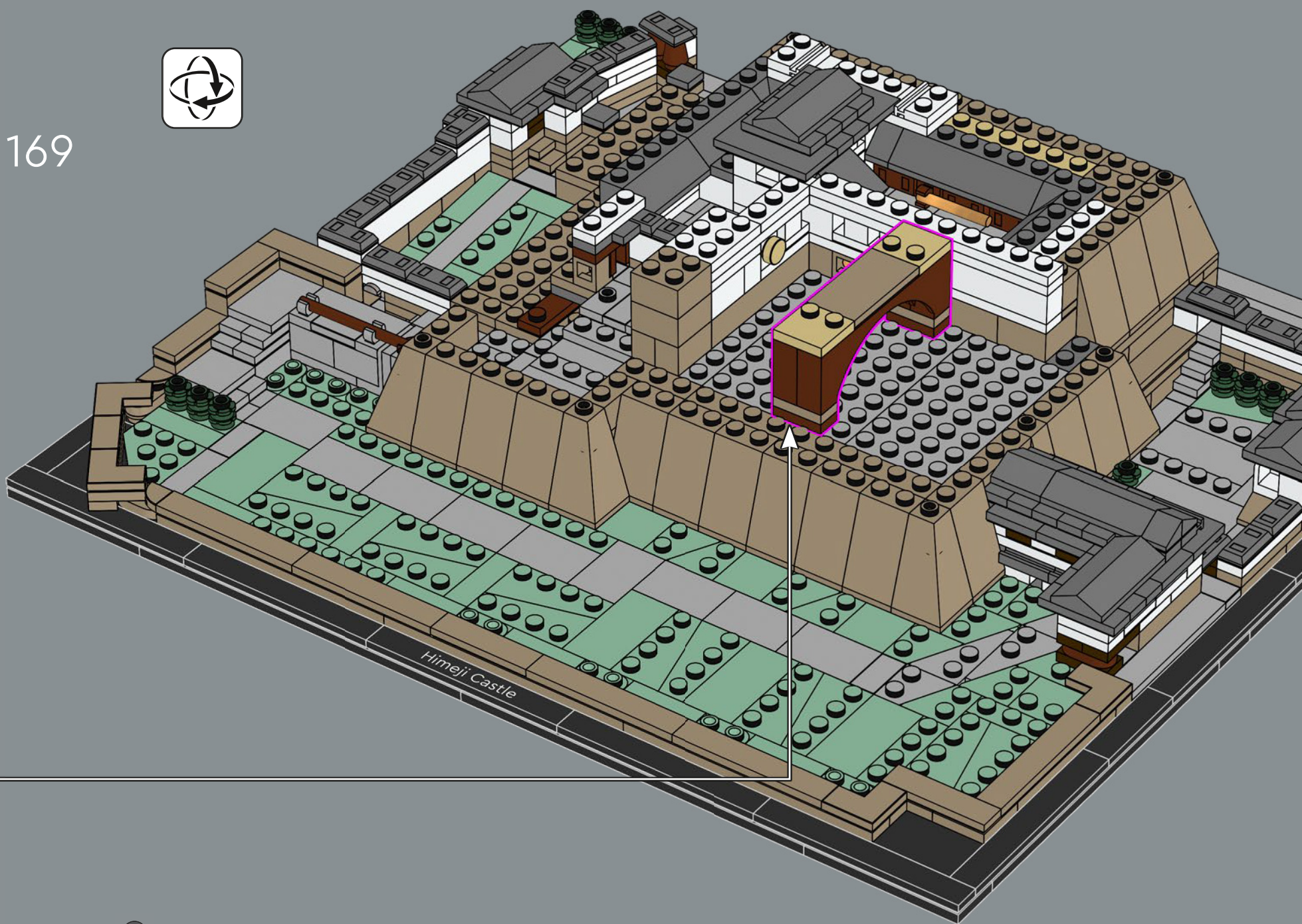

Himeji Castle





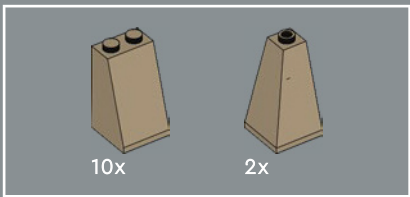

170

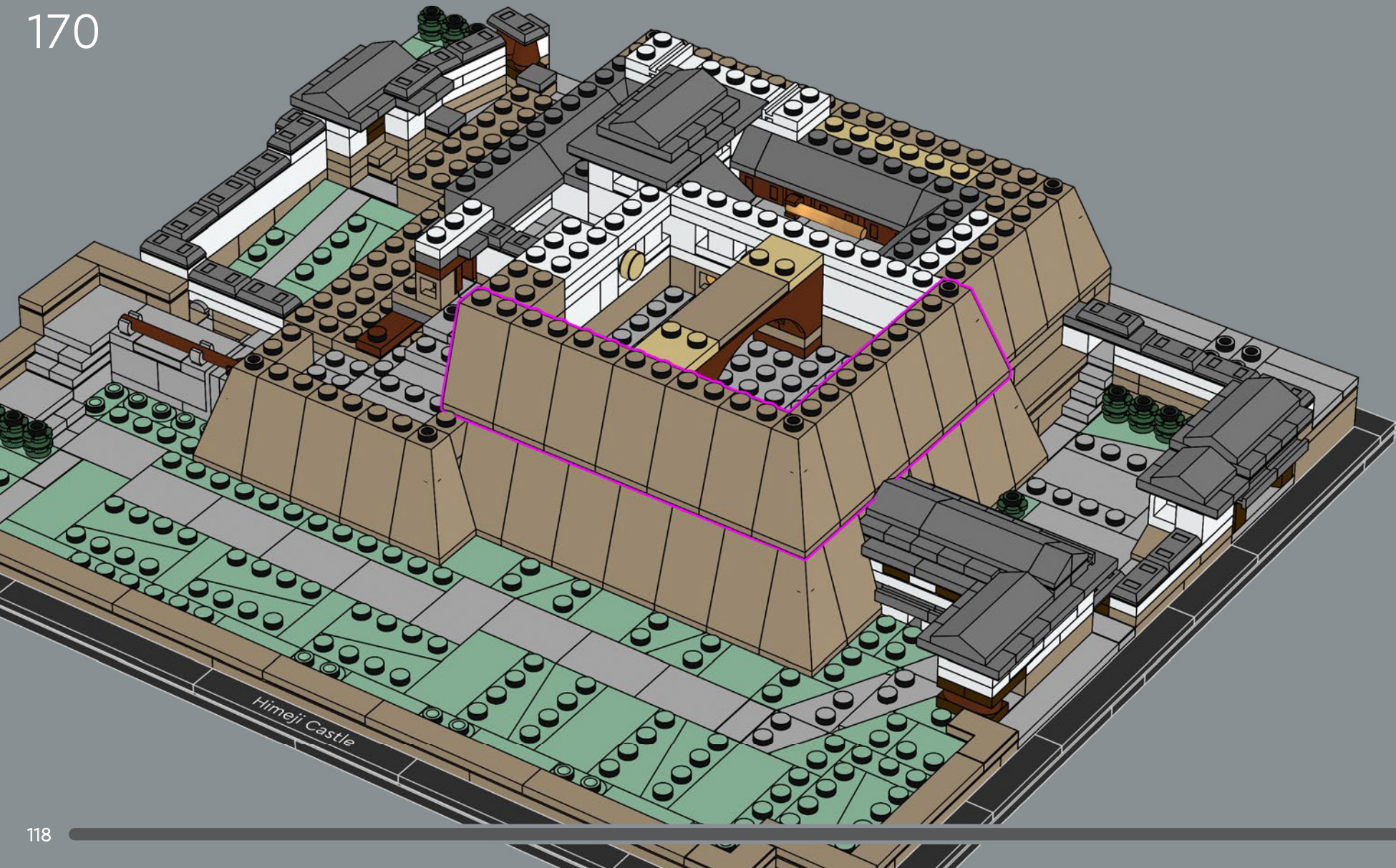



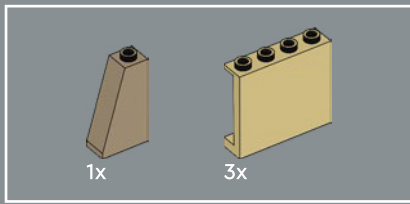

171



Himeji Castle



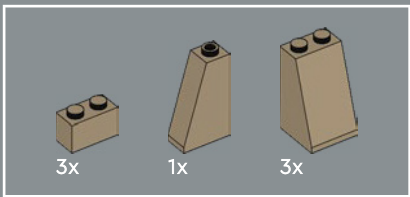

172

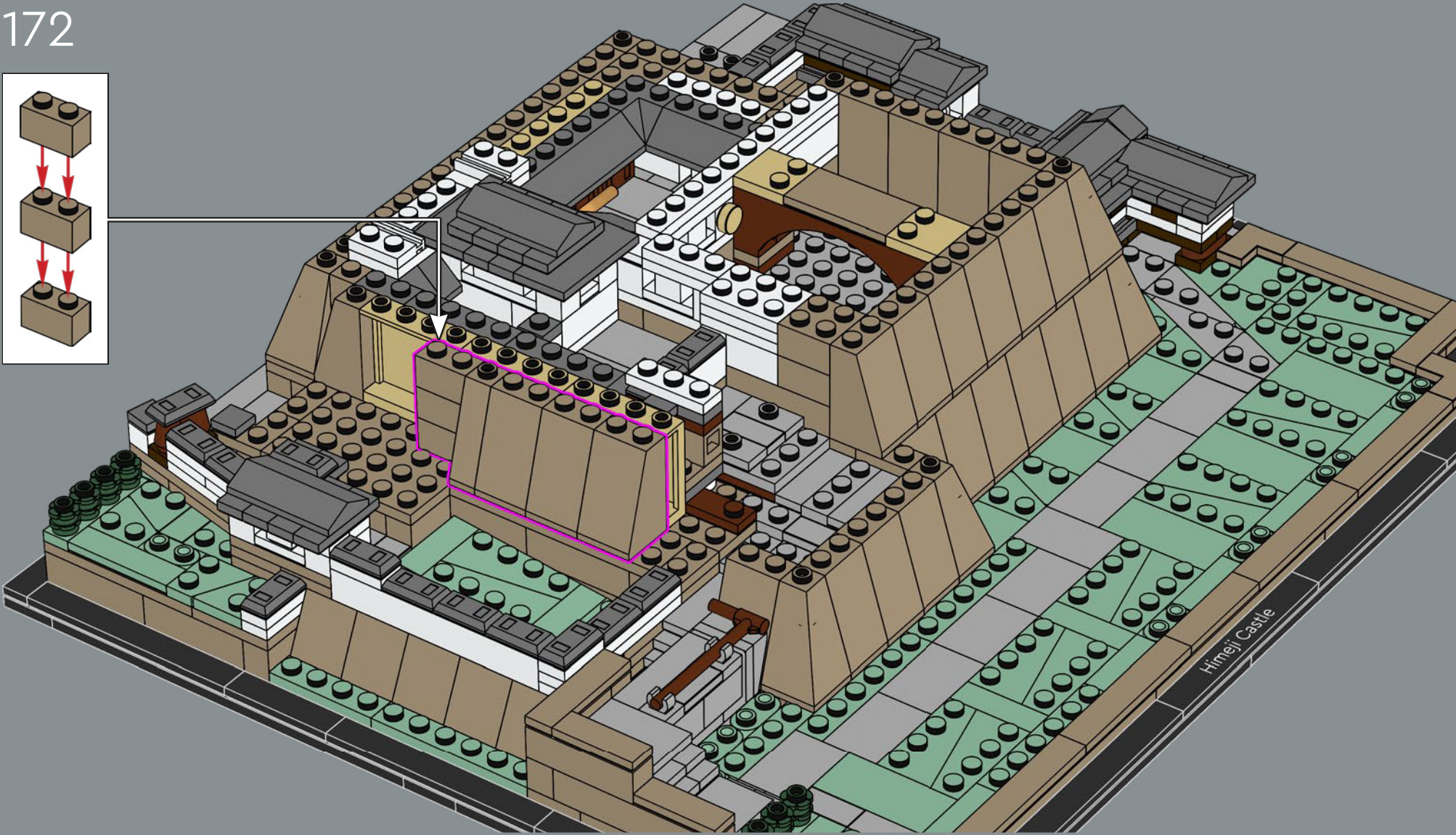
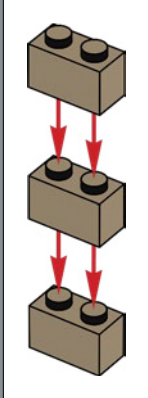



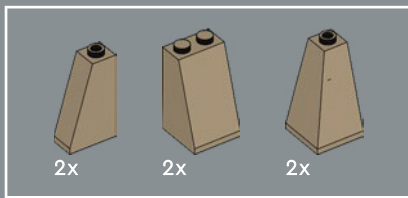

173



Himeji Castle



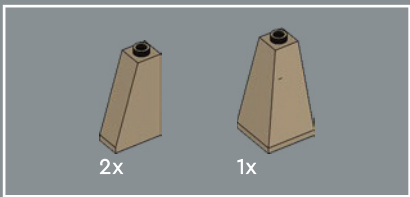

174

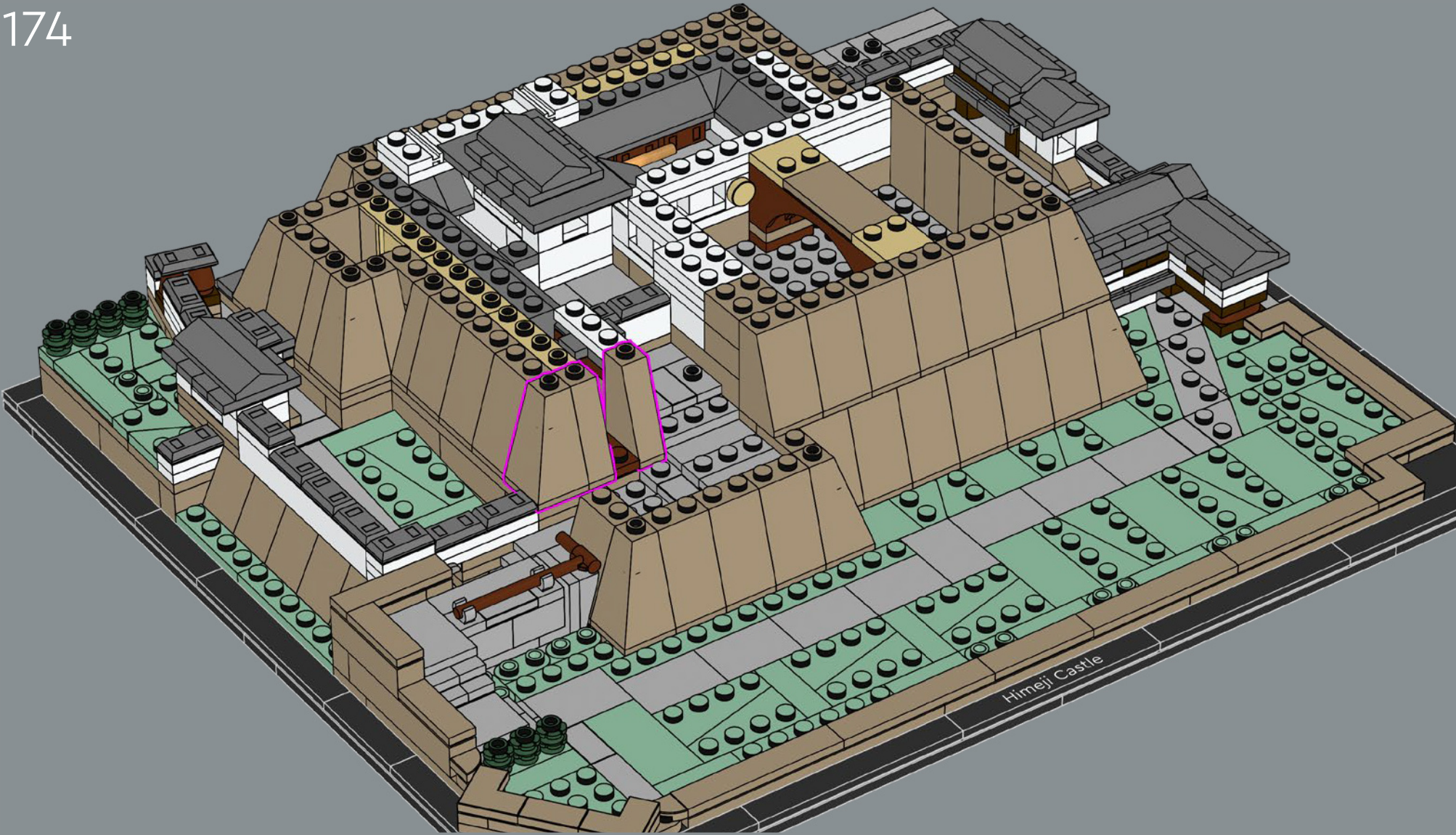



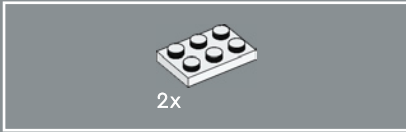
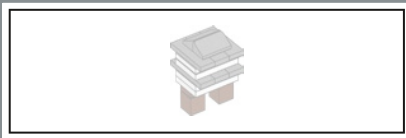

175

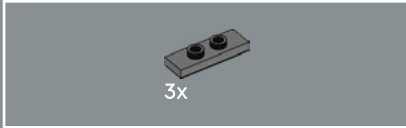
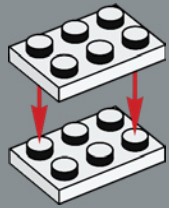

176

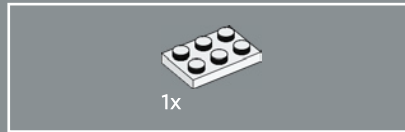

177

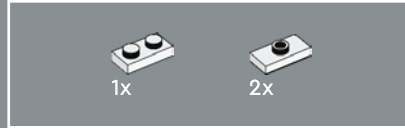
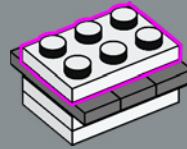

178

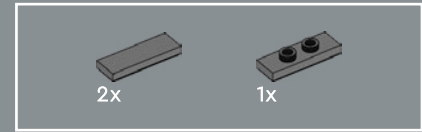
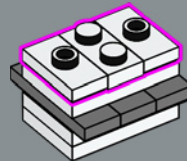

179

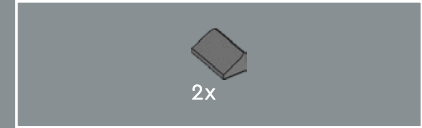
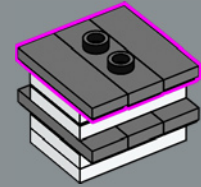

180

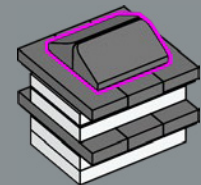

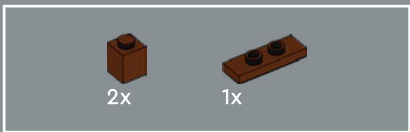

181

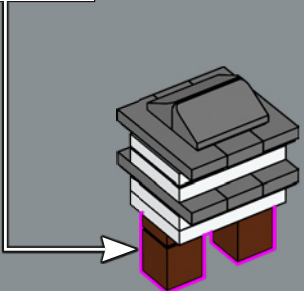
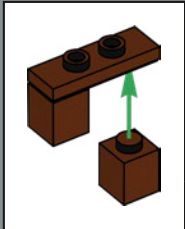

182

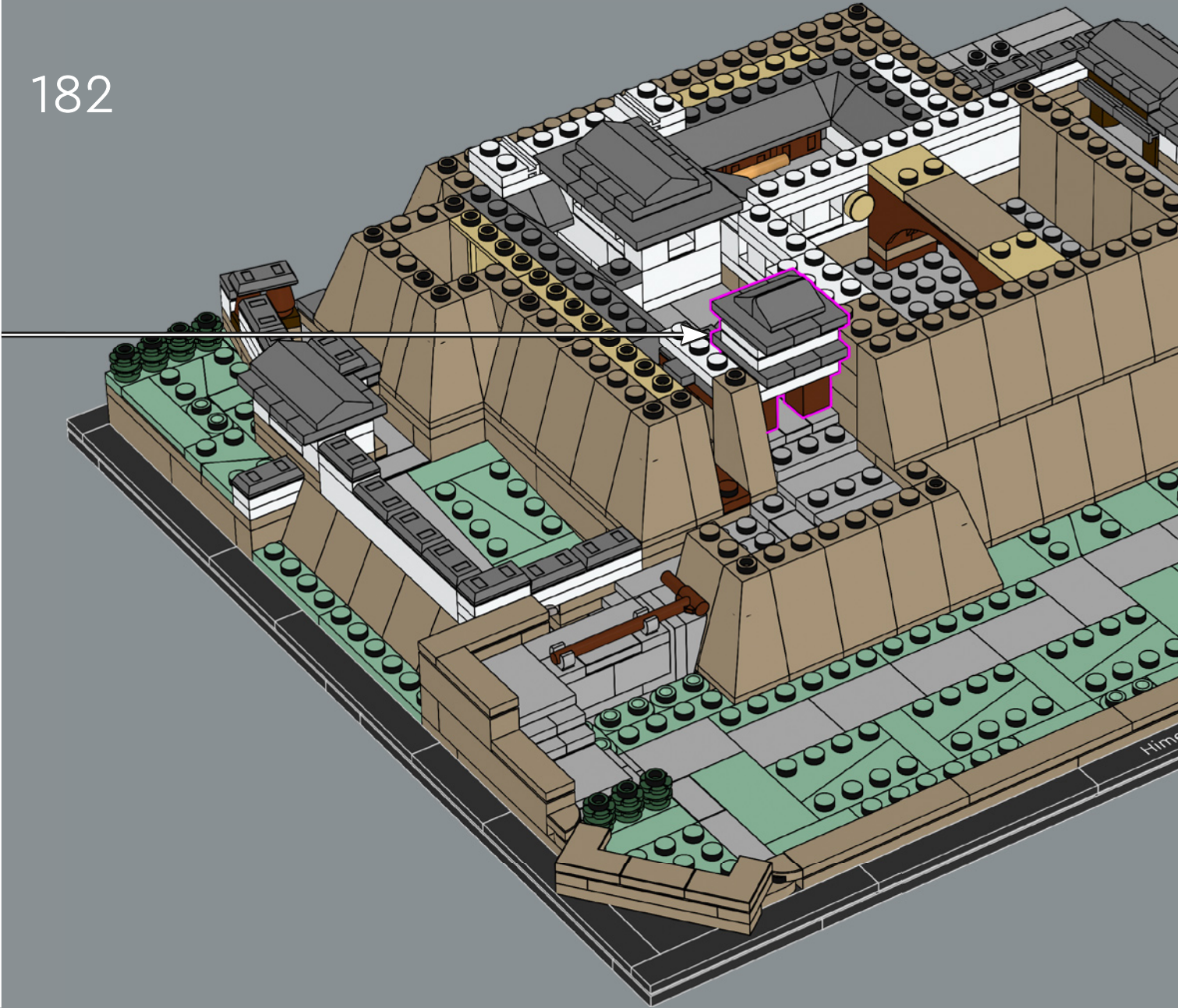



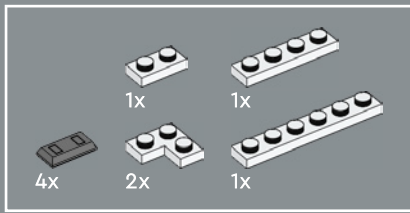

183

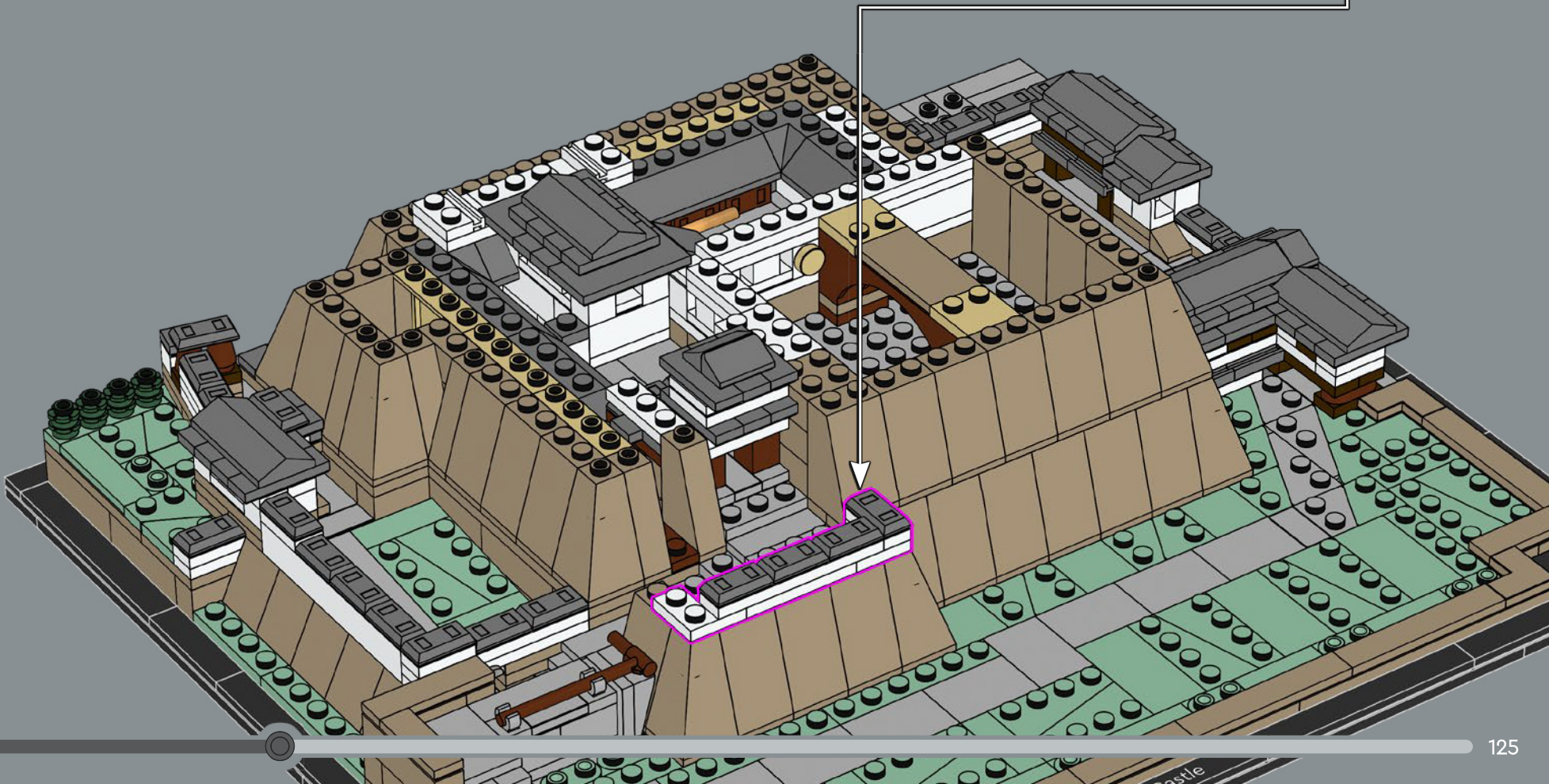
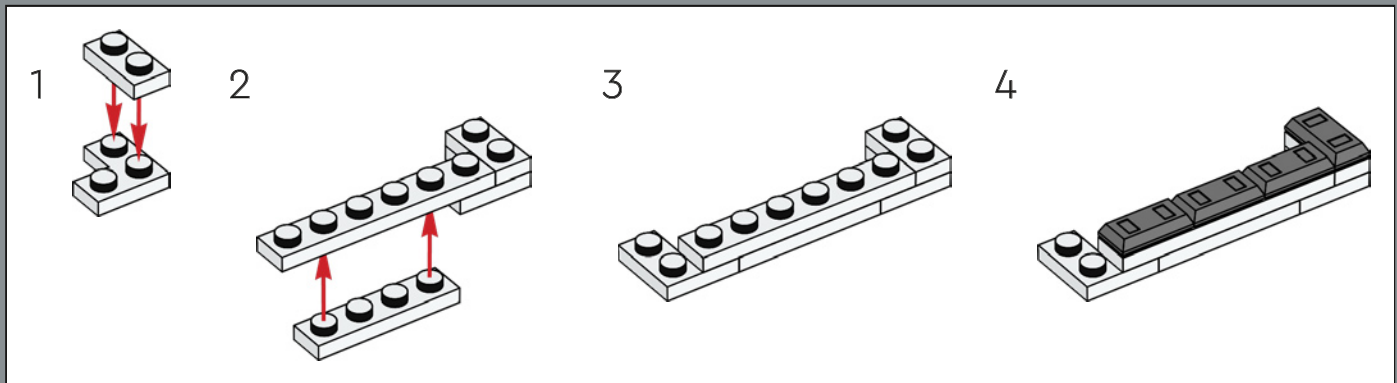



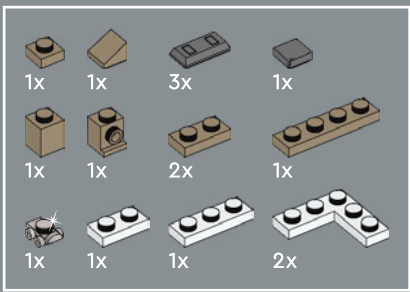

184

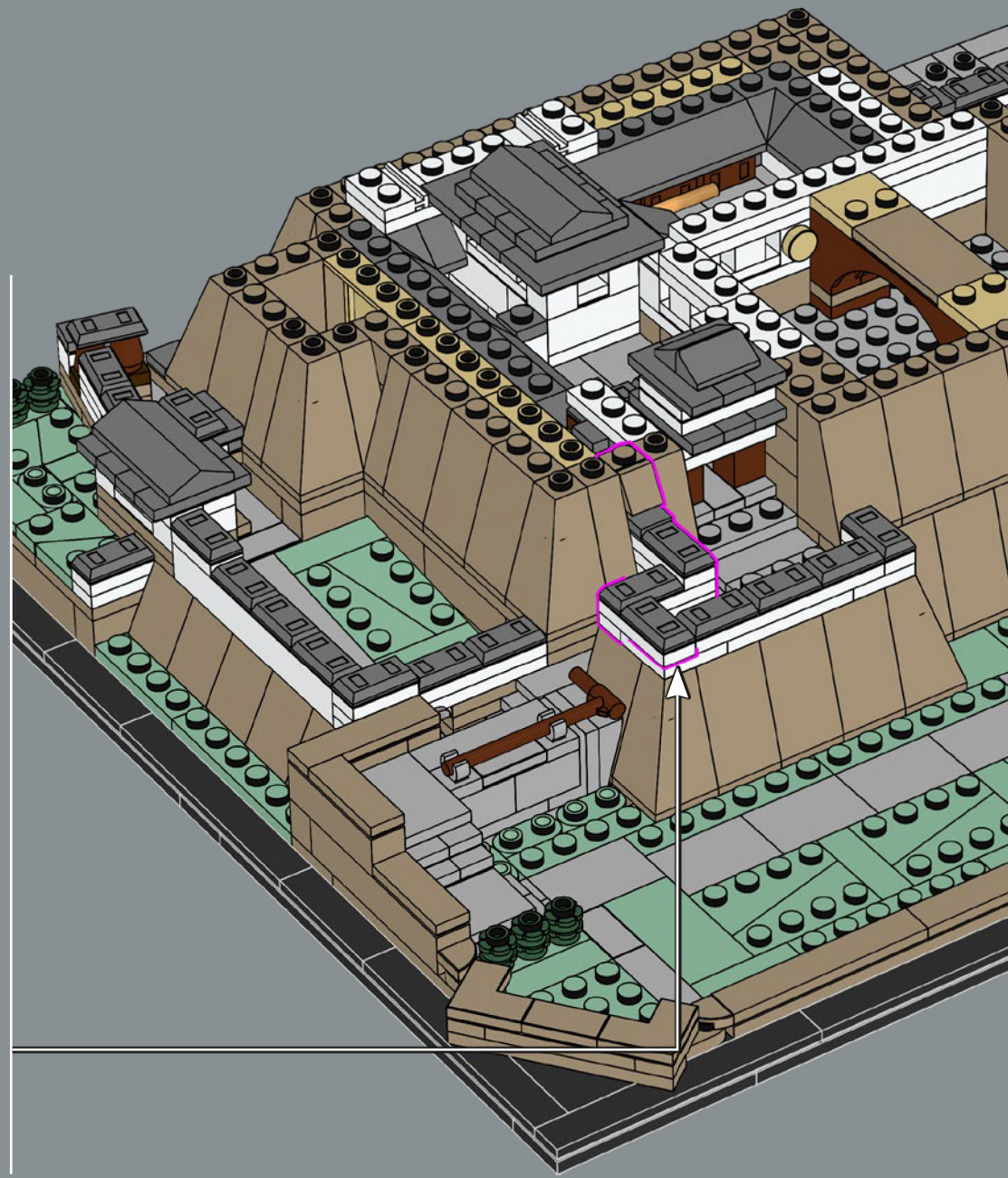
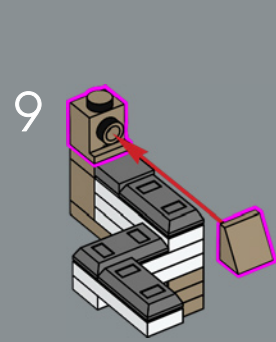
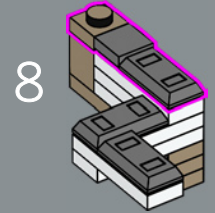
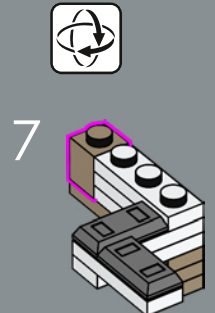
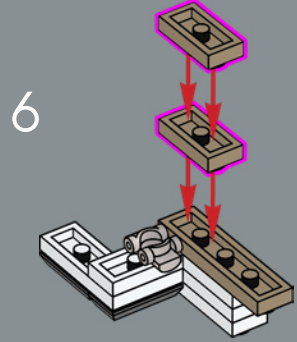
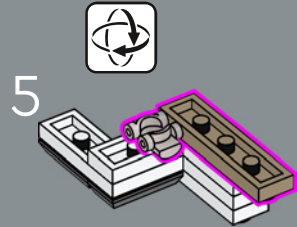
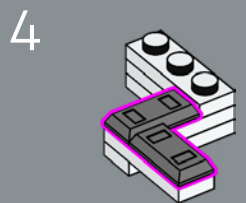
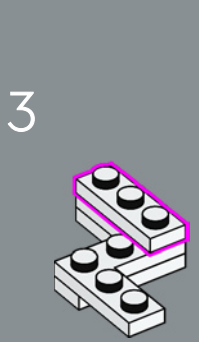
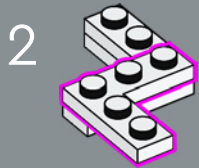
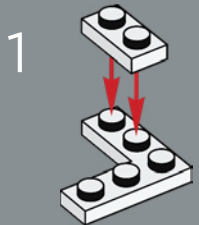



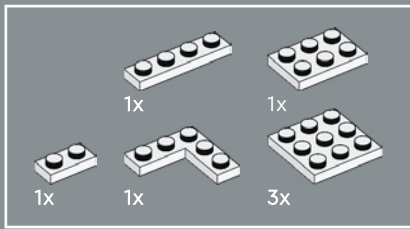

185

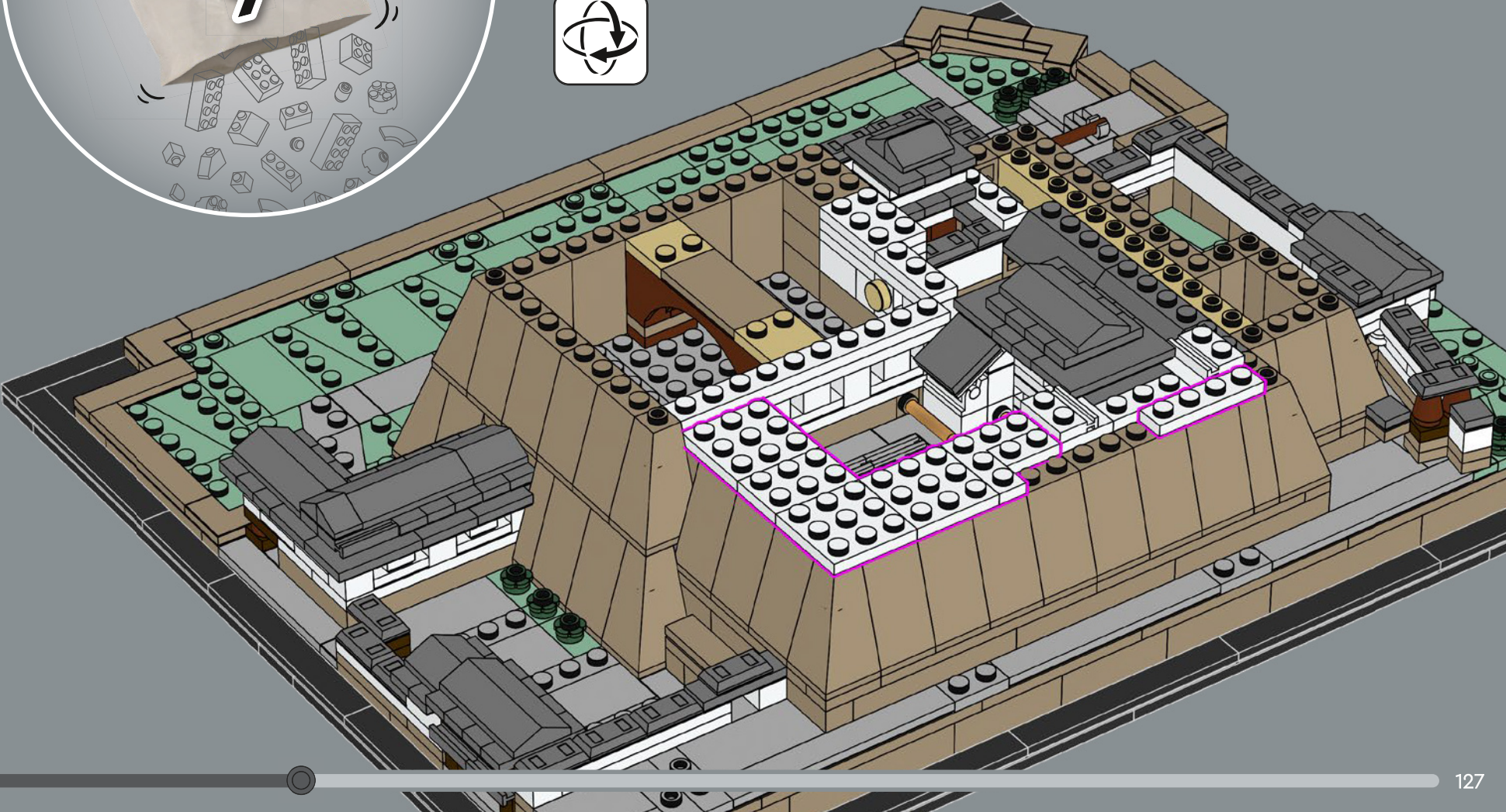



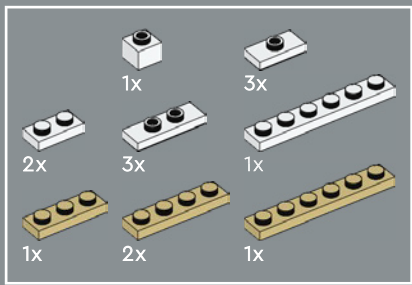

186

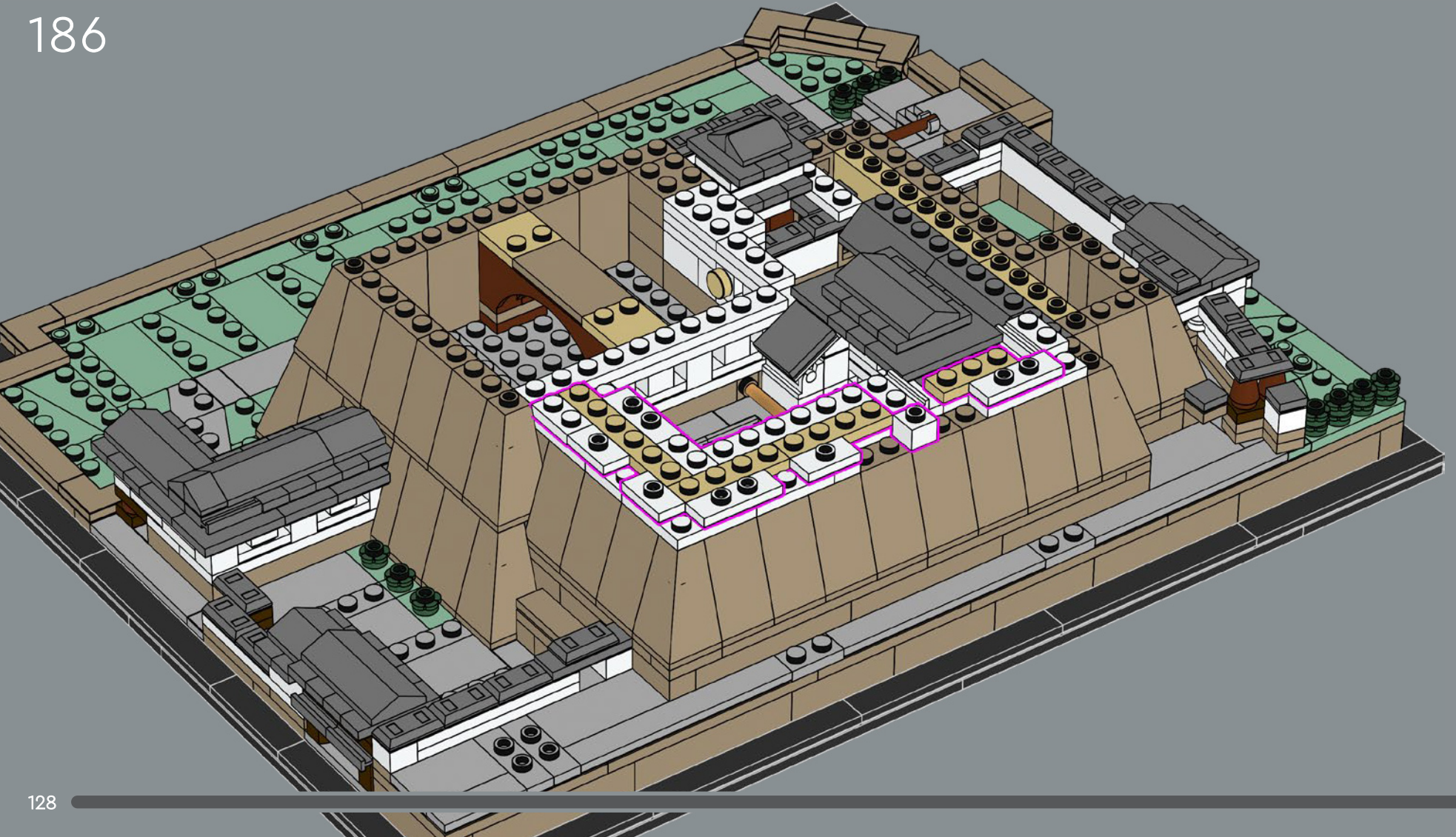



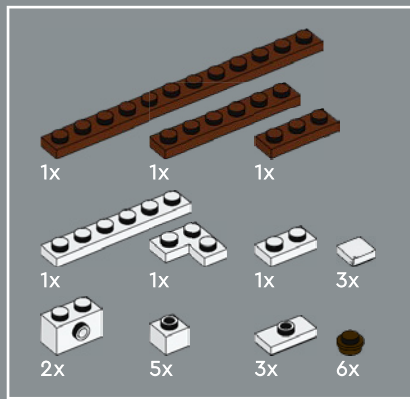

187



Während der Renovierung von 2009 bis 2015 war das Außengerüst an mehreren Seiten mit kunstvollen Strichzeichnungen der Burg verkleidet, um das legendäre Wahrzeichen an der Skyline von Himeji zu erhalten.



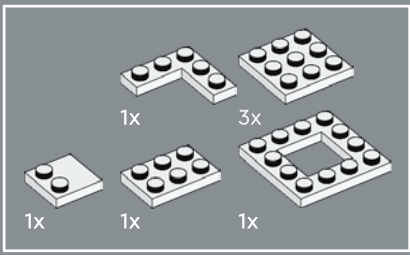

188

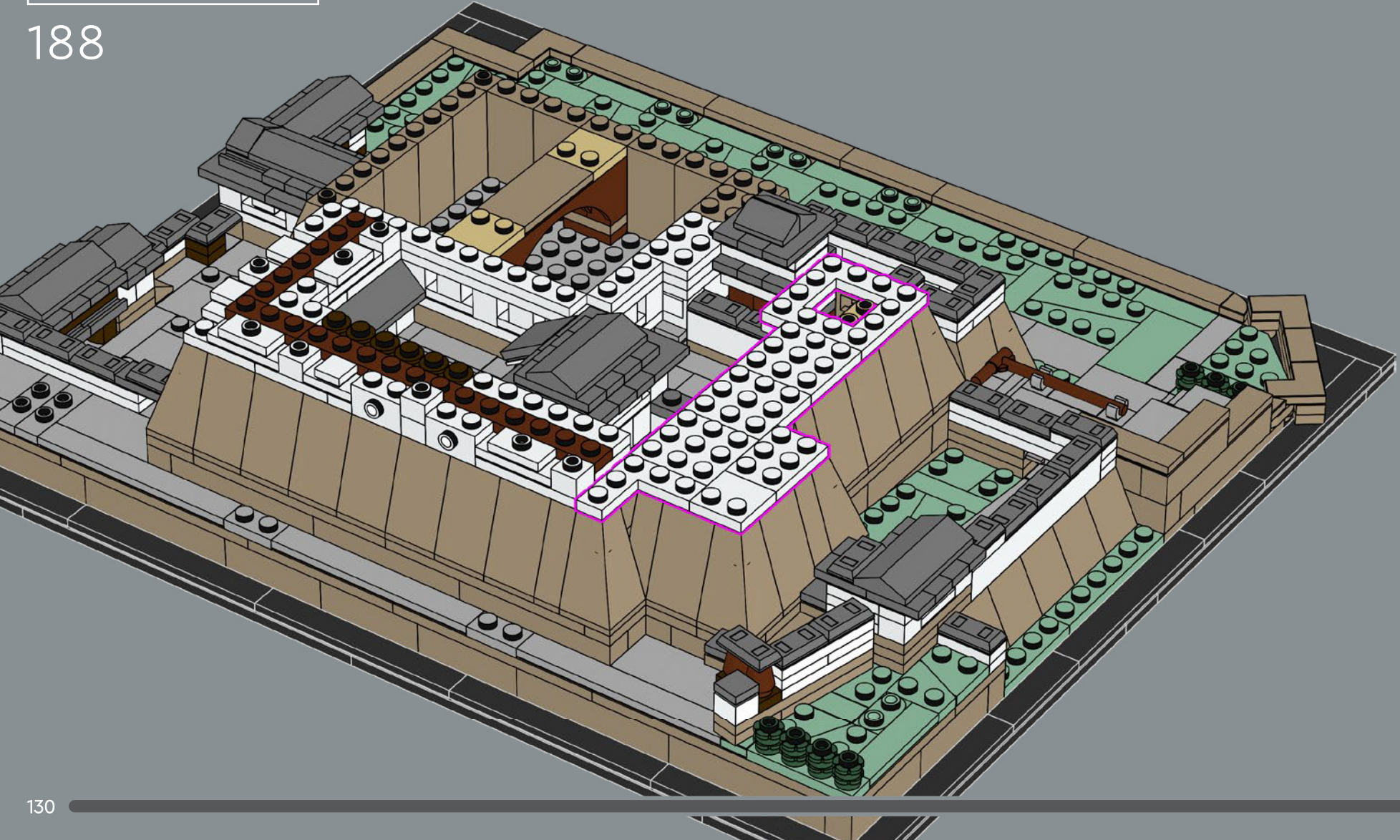



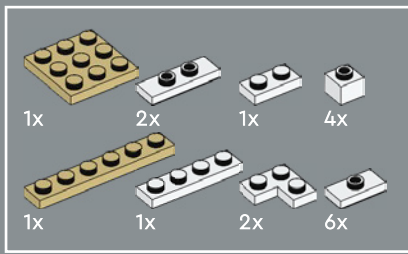

189

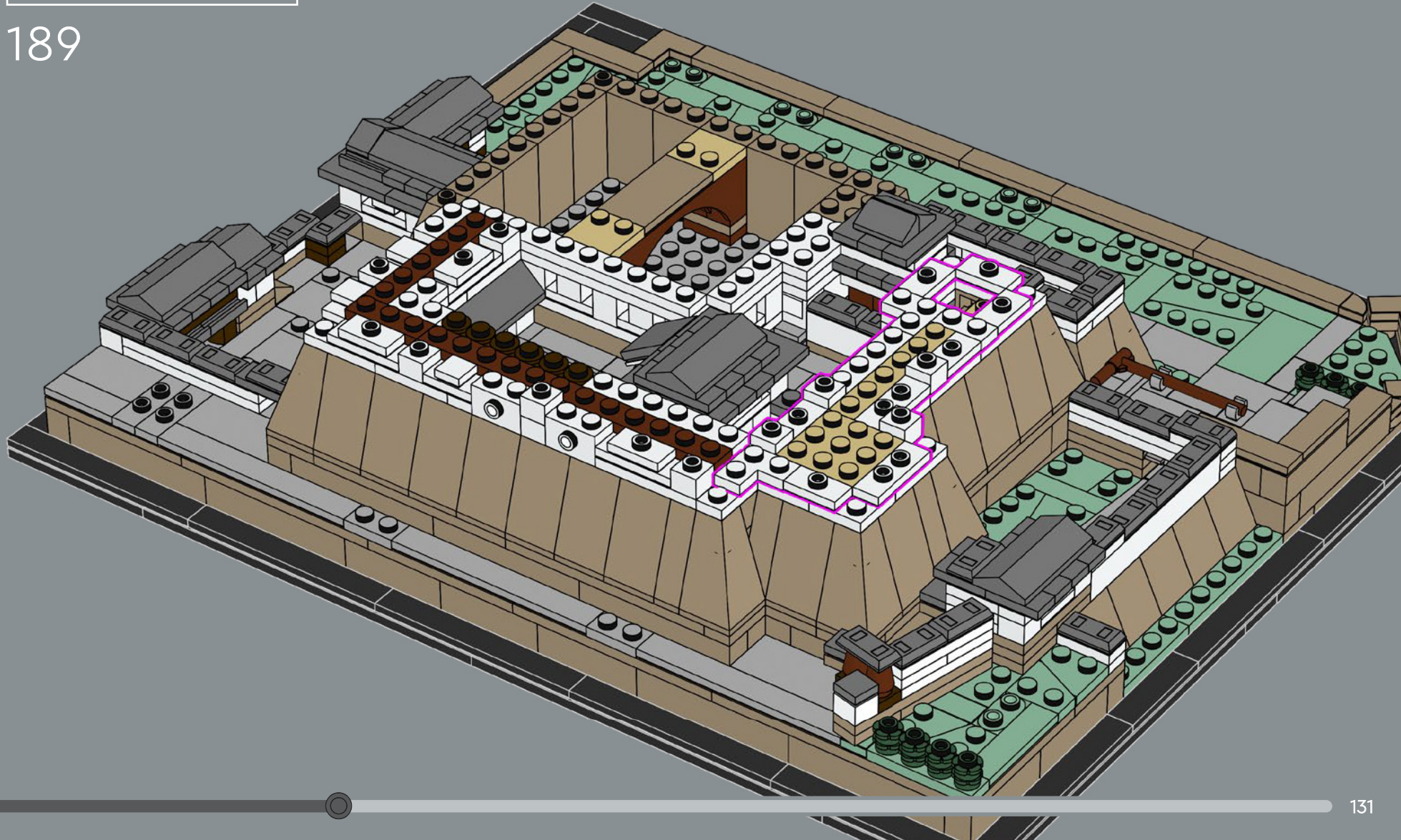



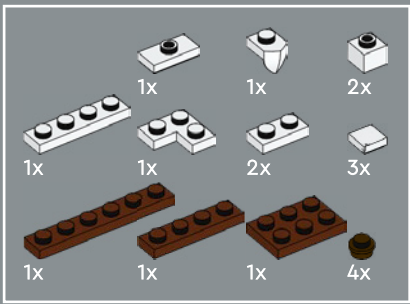

190





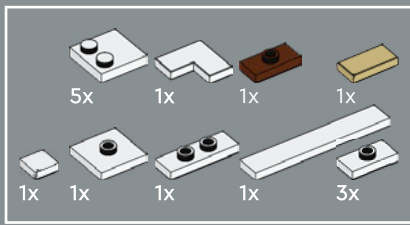

191

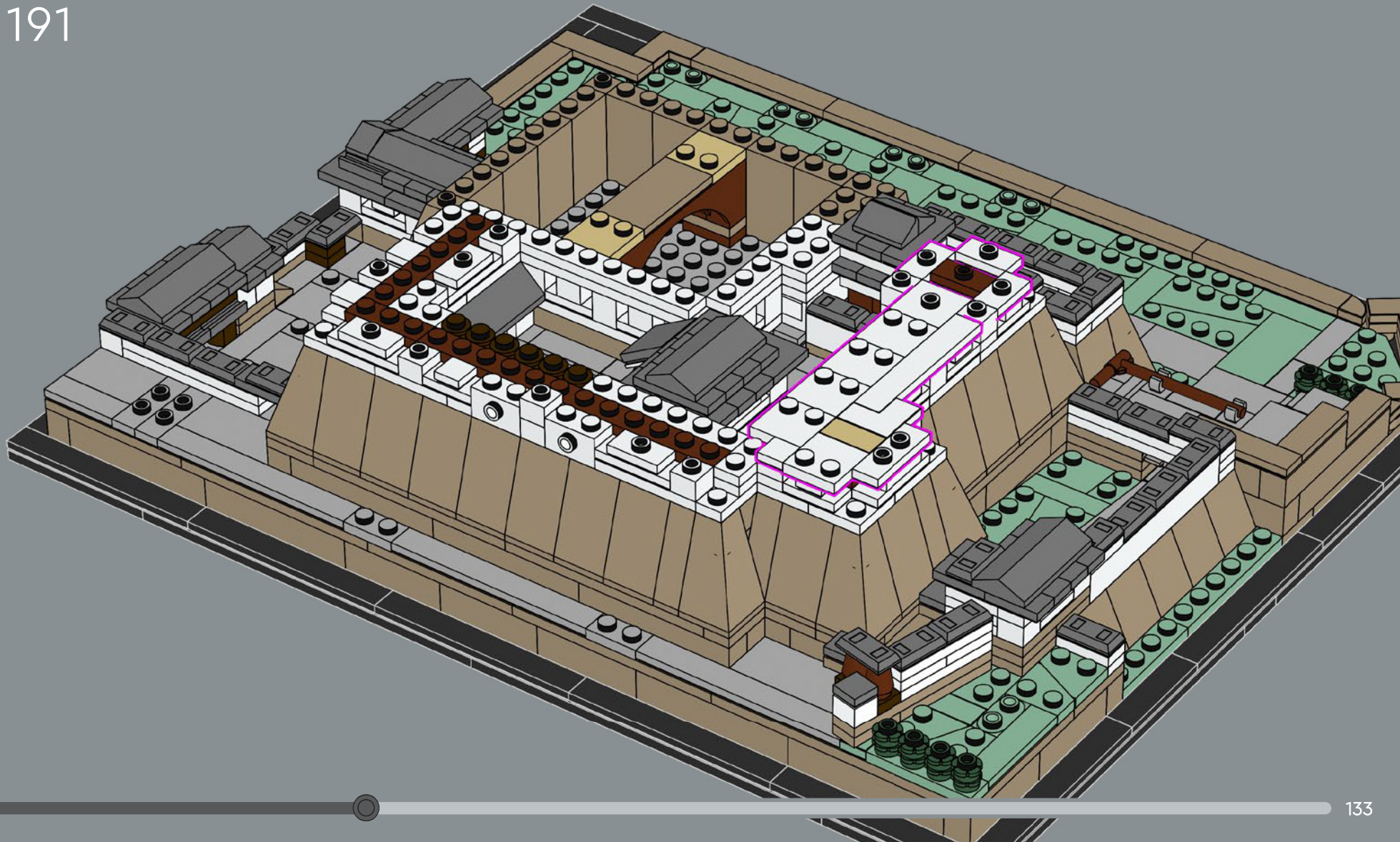



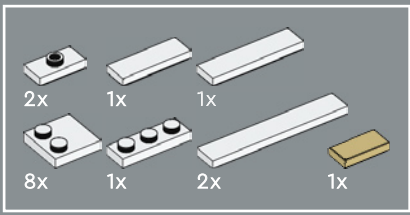

192

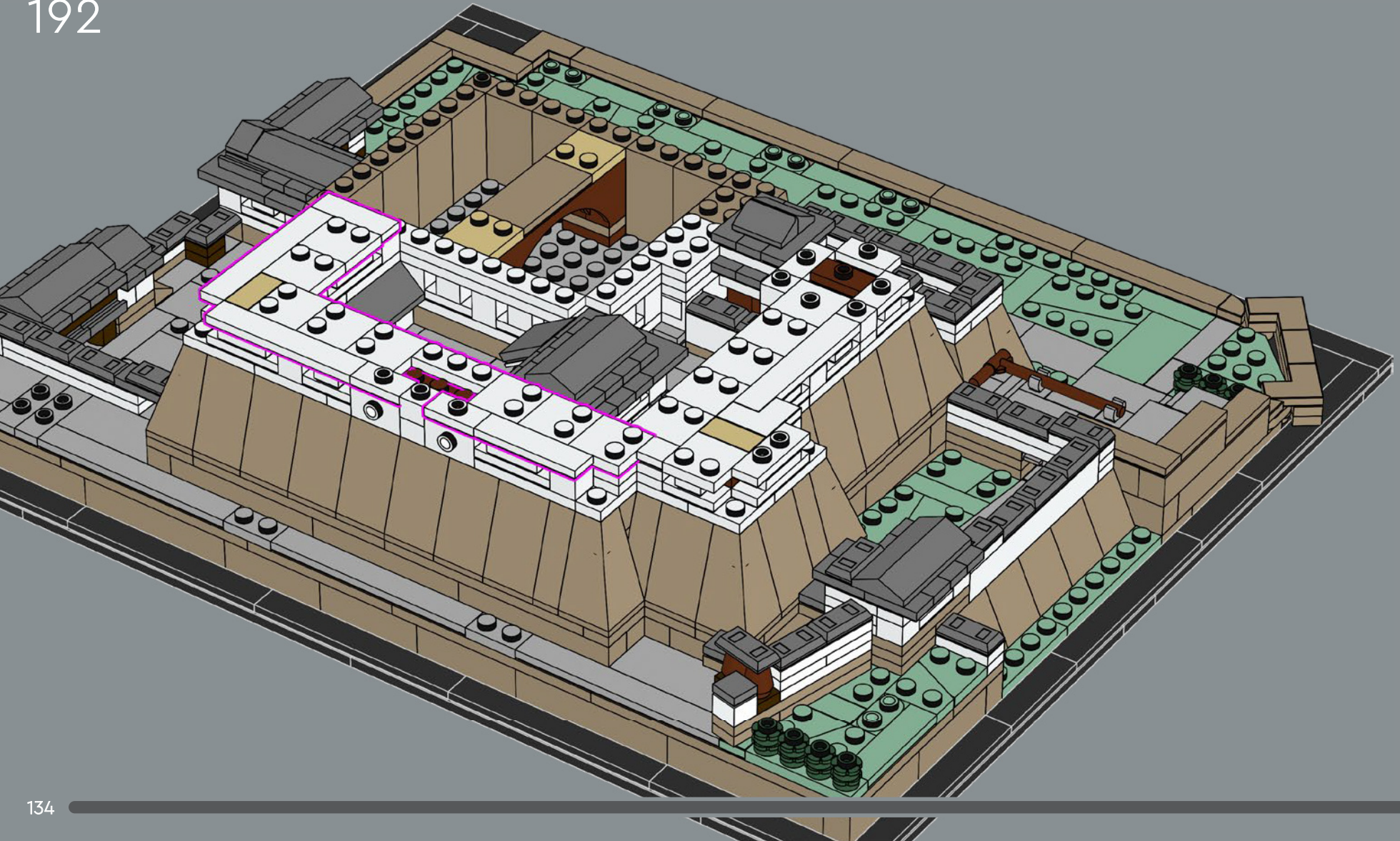



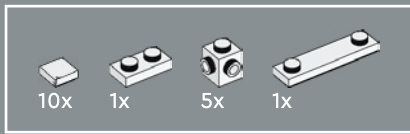

193

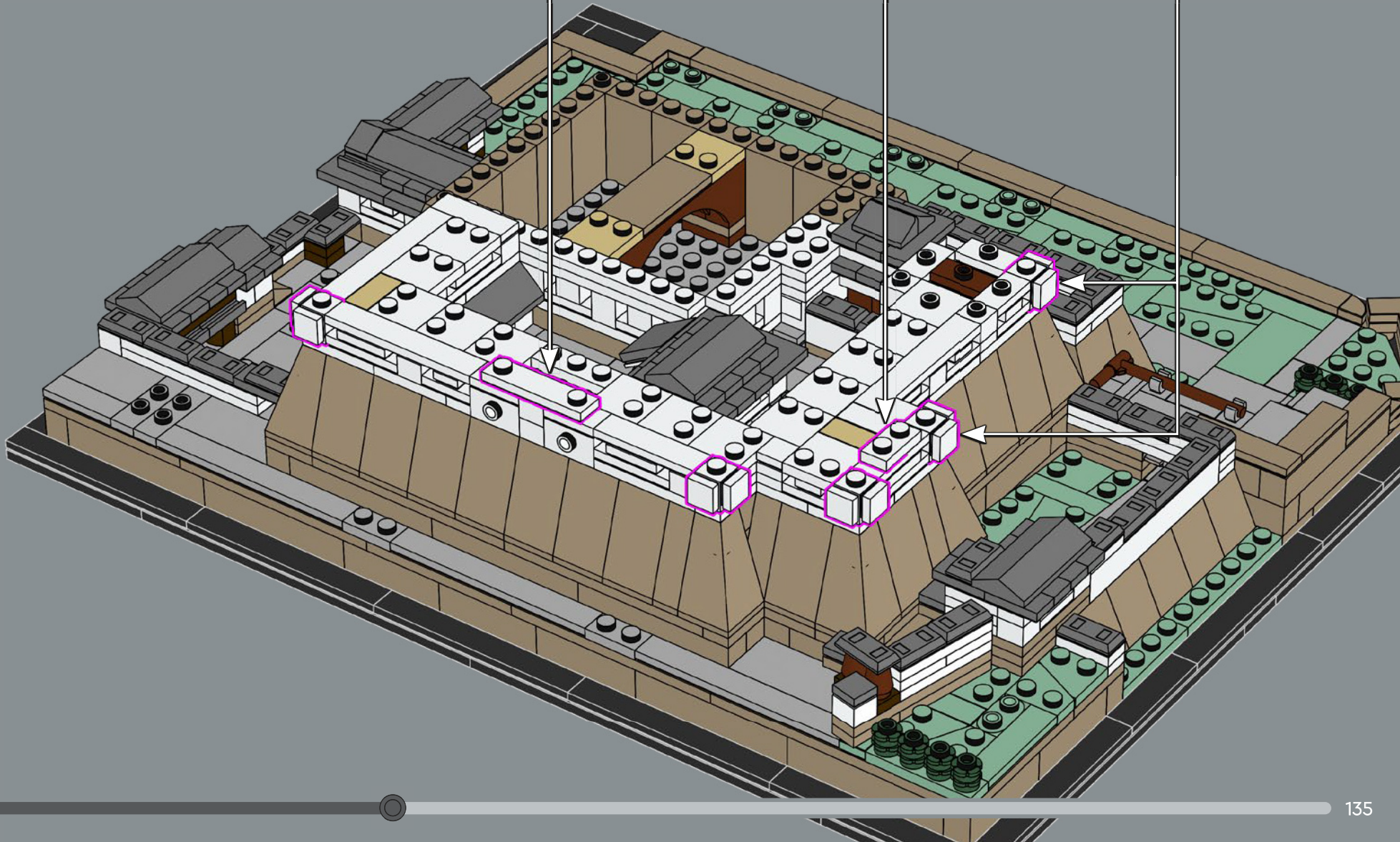
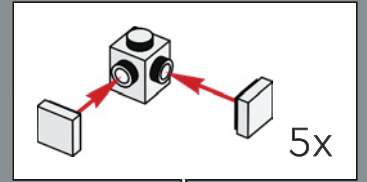
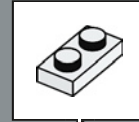
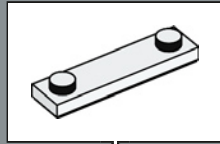



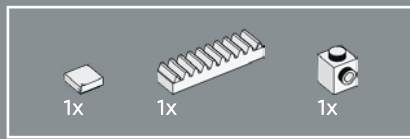

194

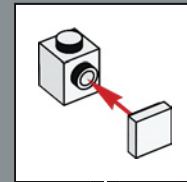
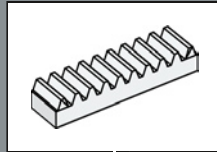



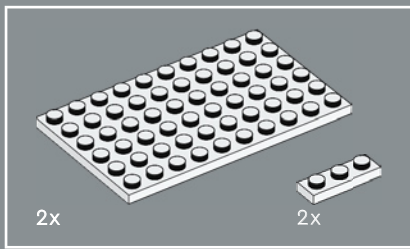

195





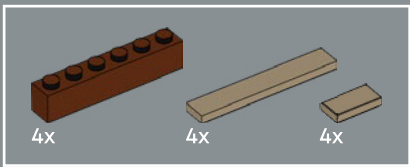

196

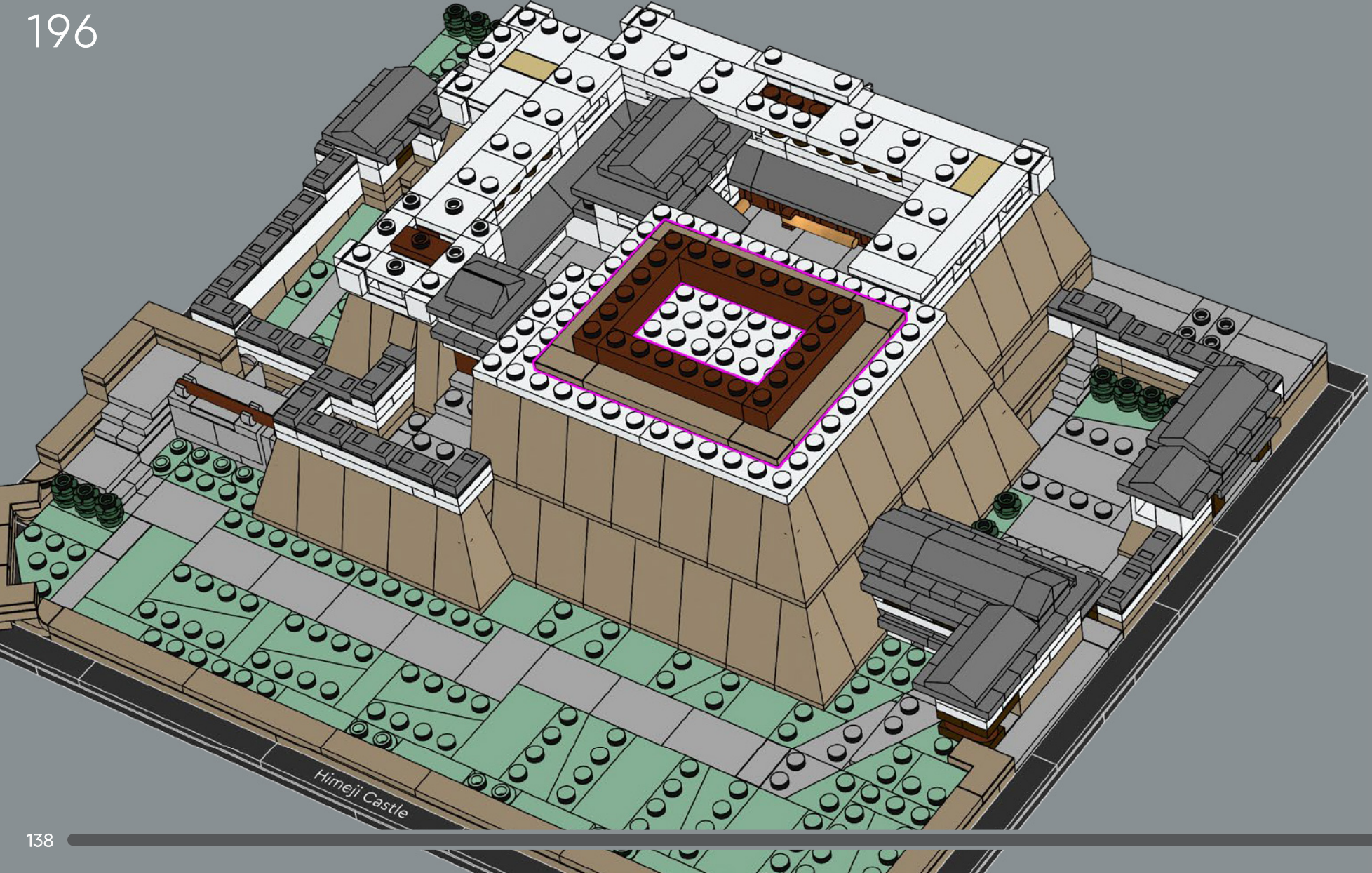



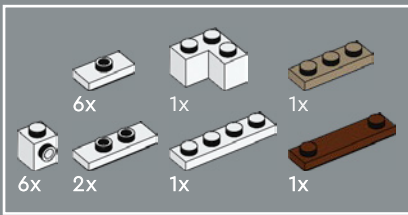

197

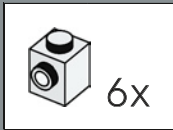
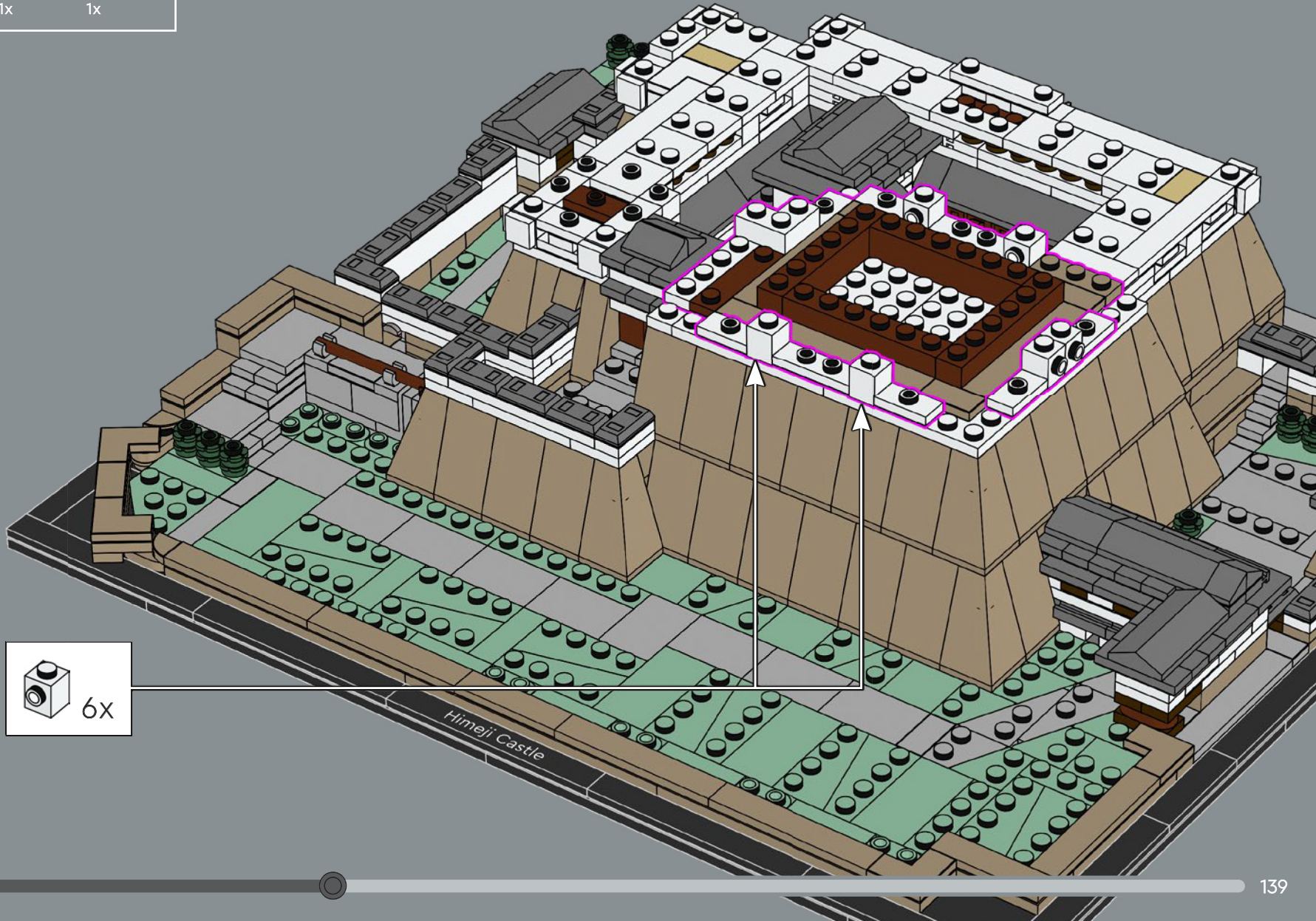



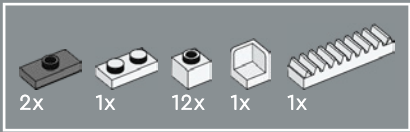

198

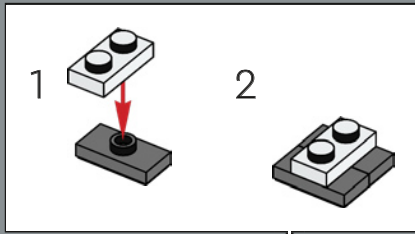



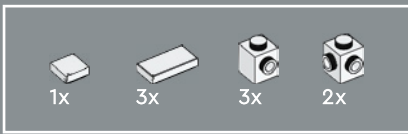

199

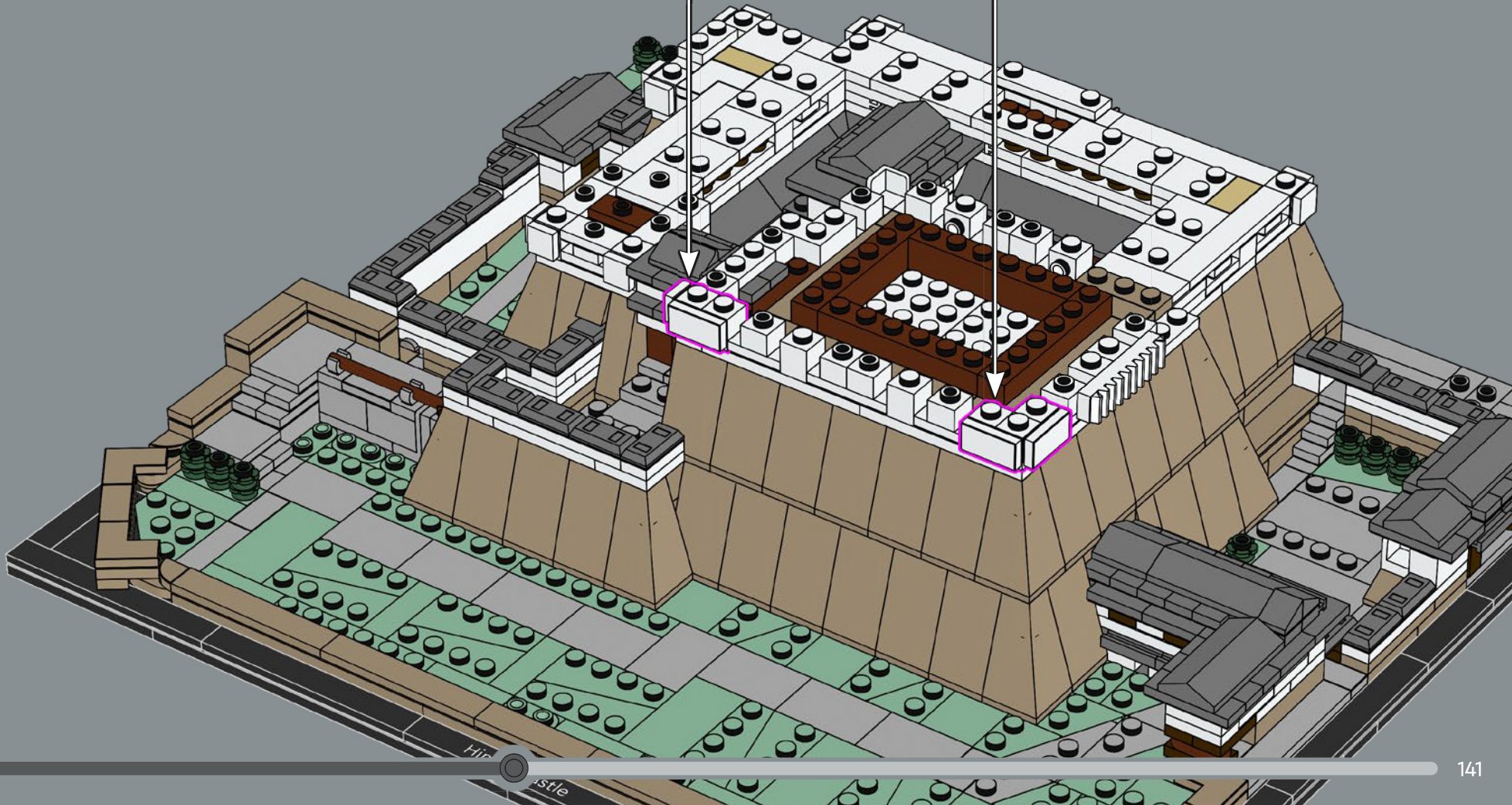
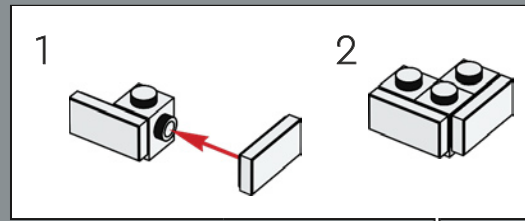
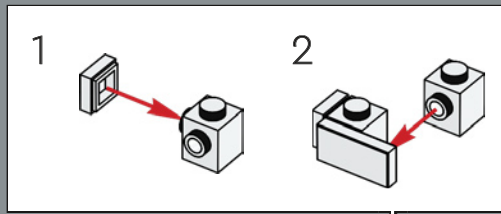



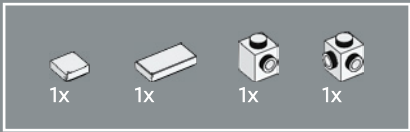

200

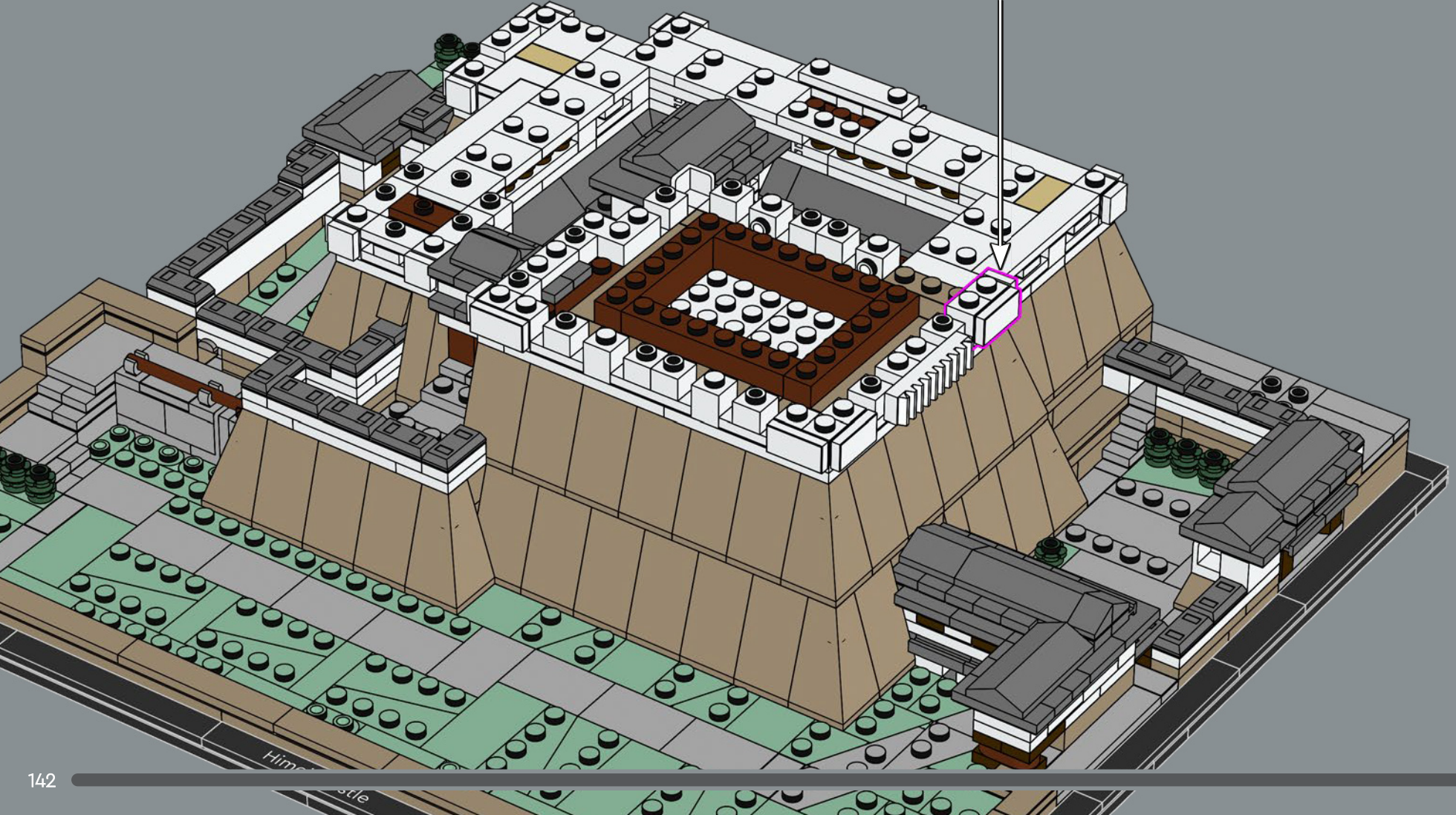
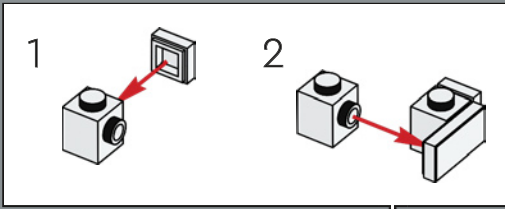



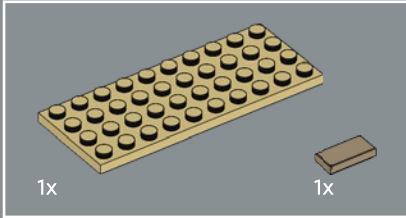
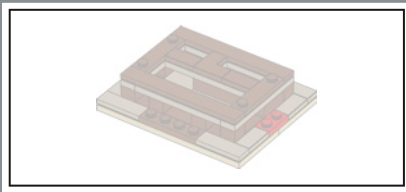

201

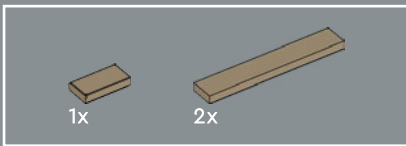
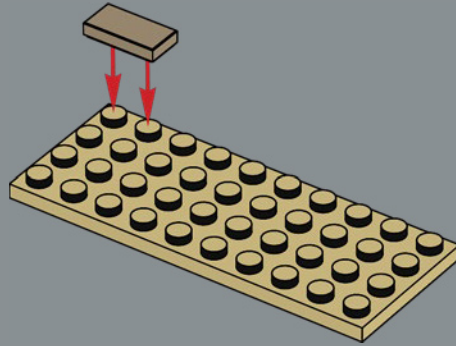

202

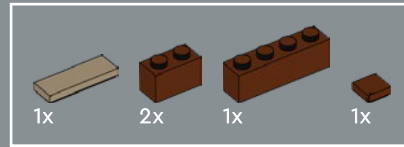
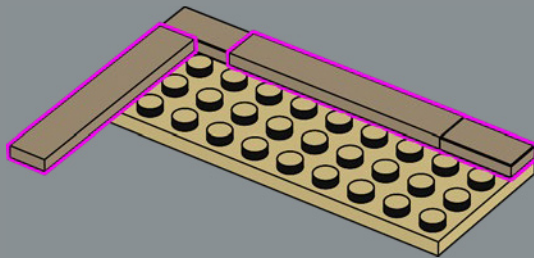

203

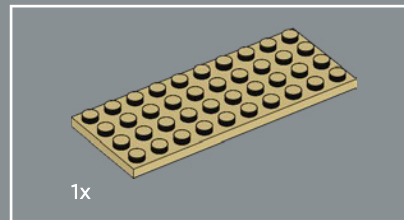
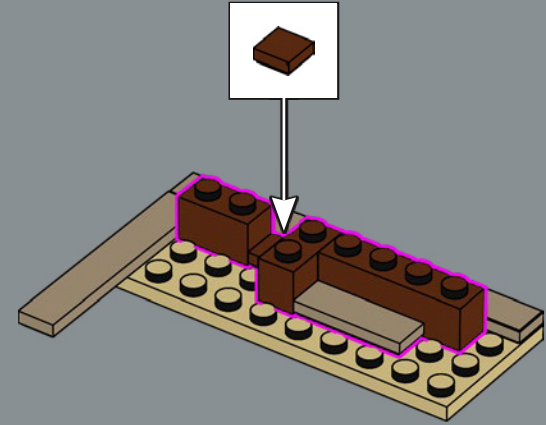

204

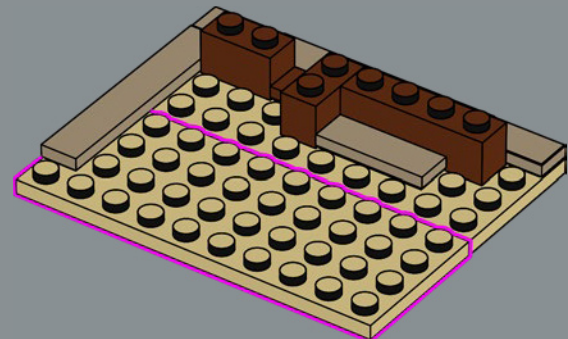

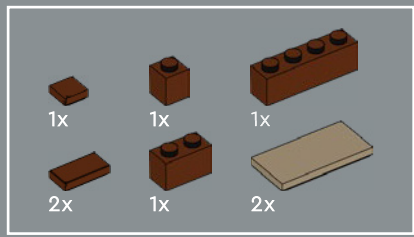

205

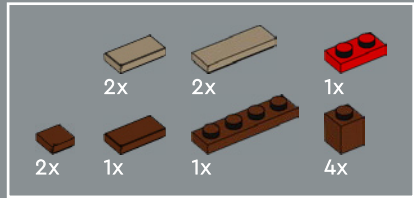
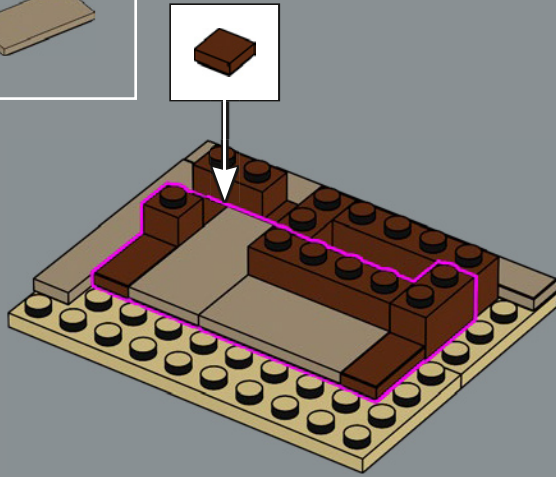

206

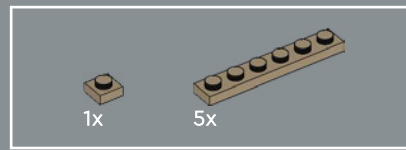
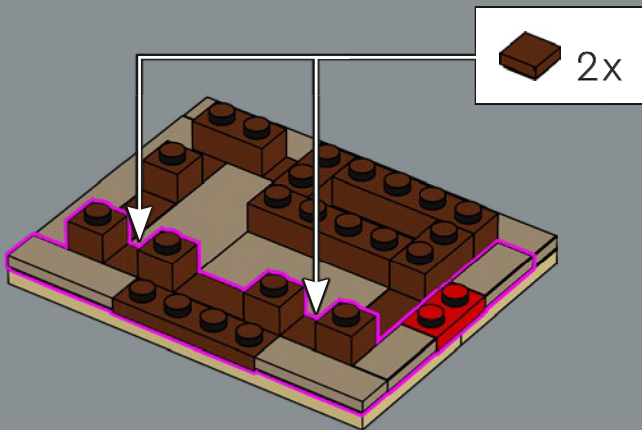

207

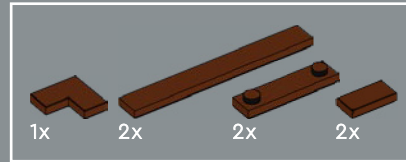
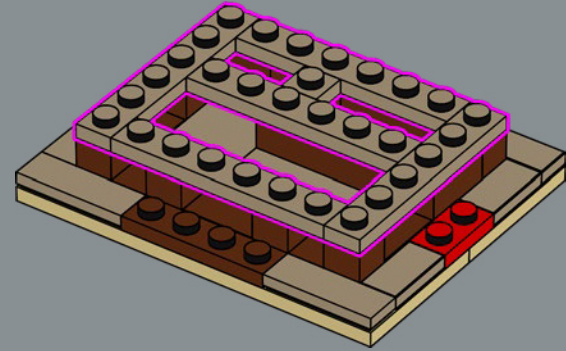

208

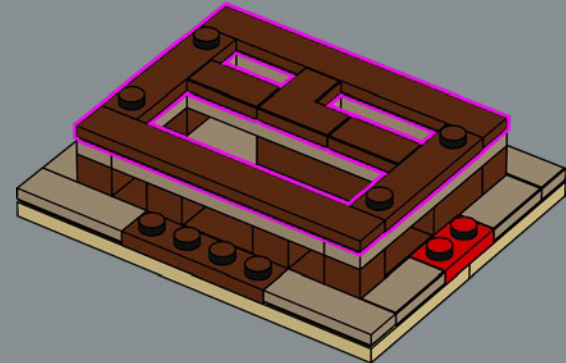



209

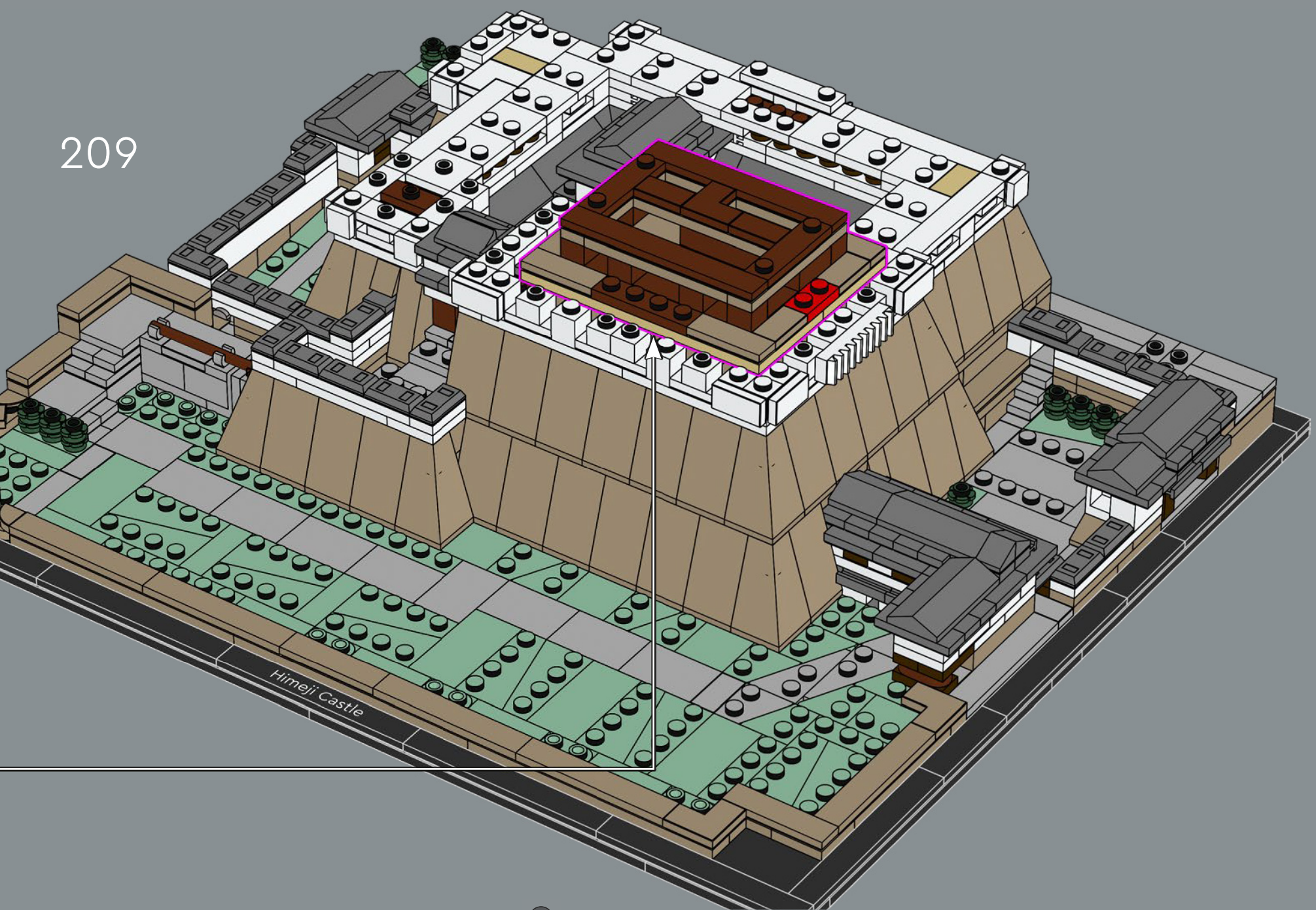

Himeji Castle



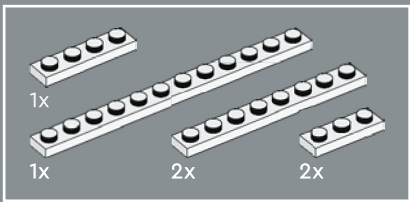

210

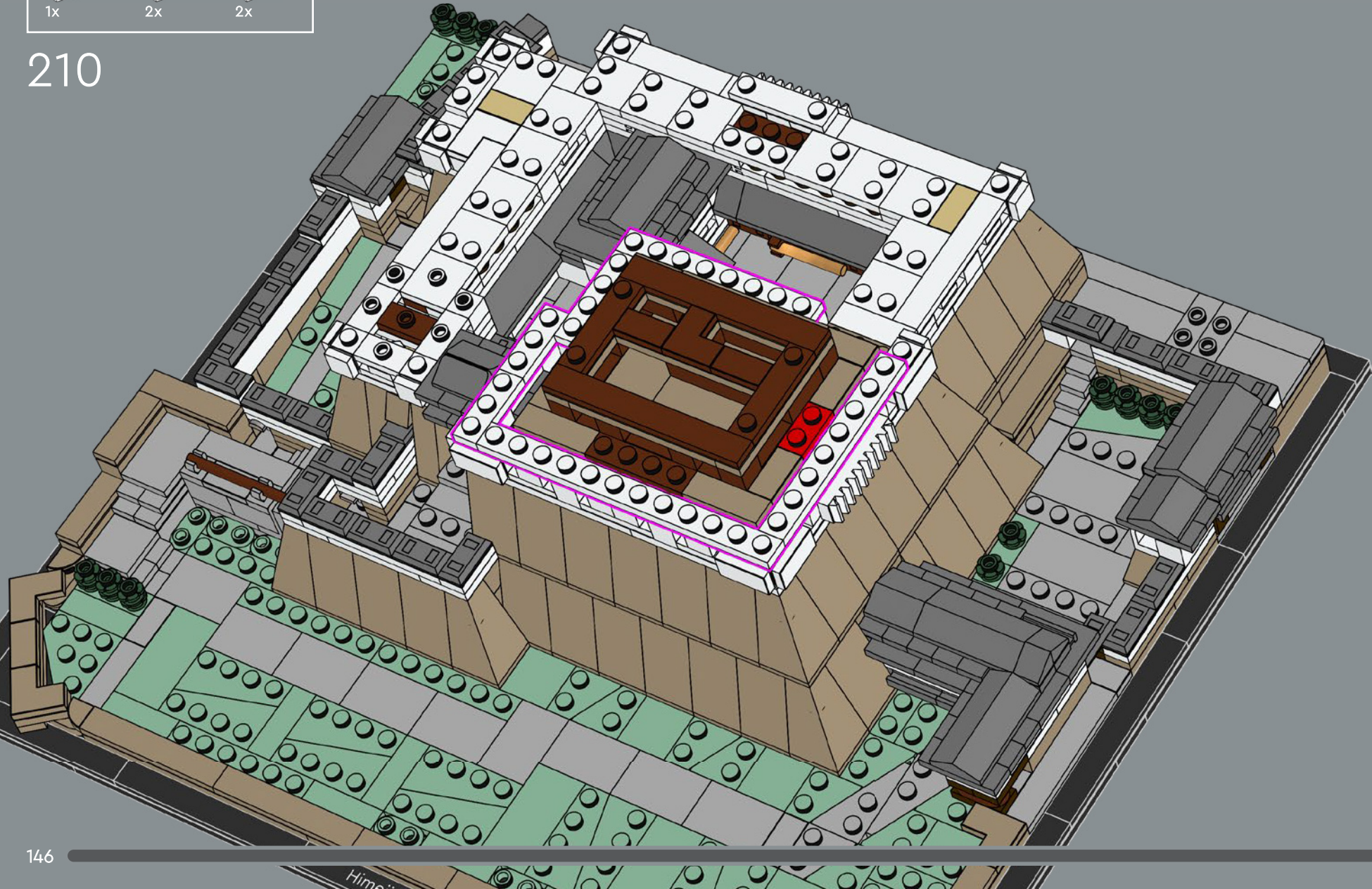



Aus Gründen der Machbarkeit mussten wir bei diesem Set häufig rechte oder andere übliche Winkel benutzen. Um das Originalbauwerk aber dennoch zu würdigen, haben wir zumindest einige der asymmetrischen Linien beibehalten.

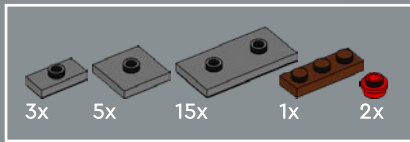

211

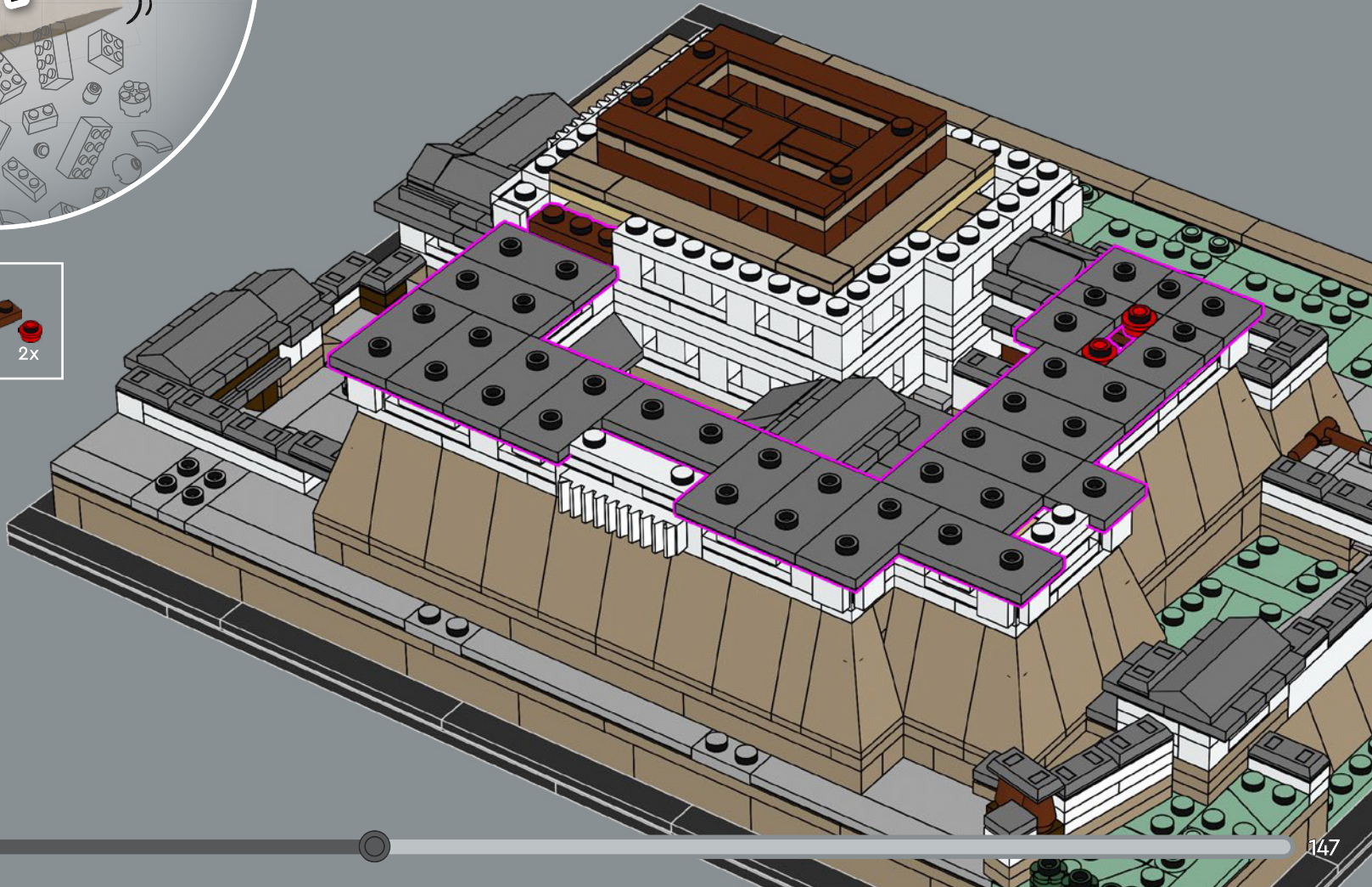



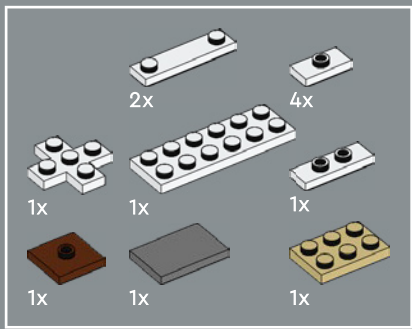

212

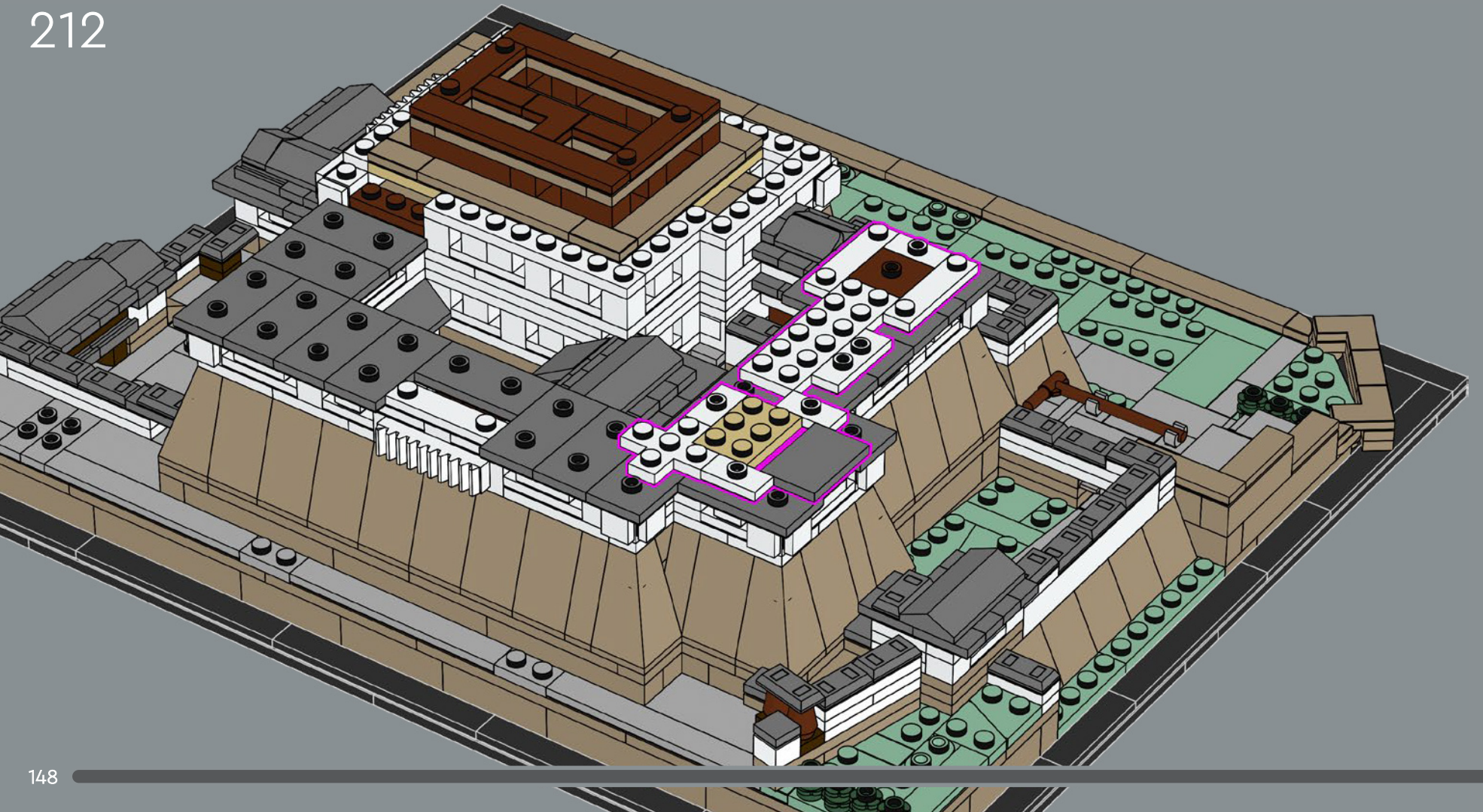



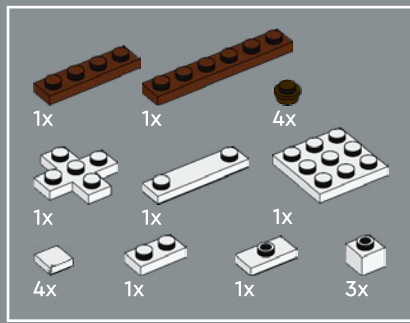

213

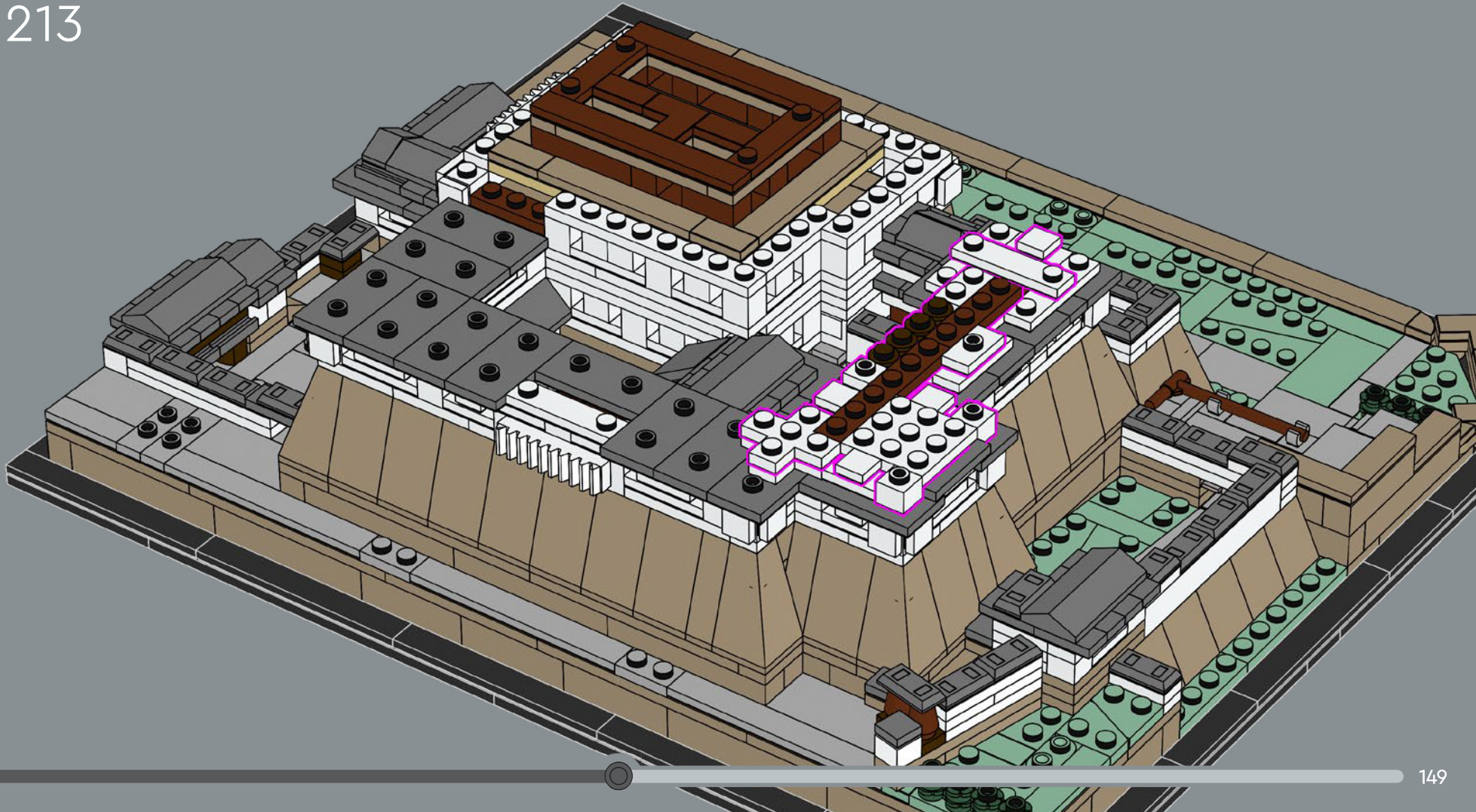



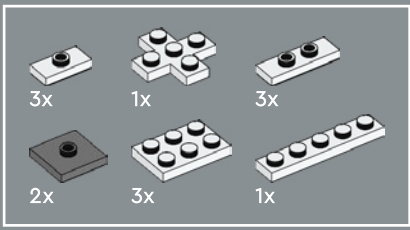

214

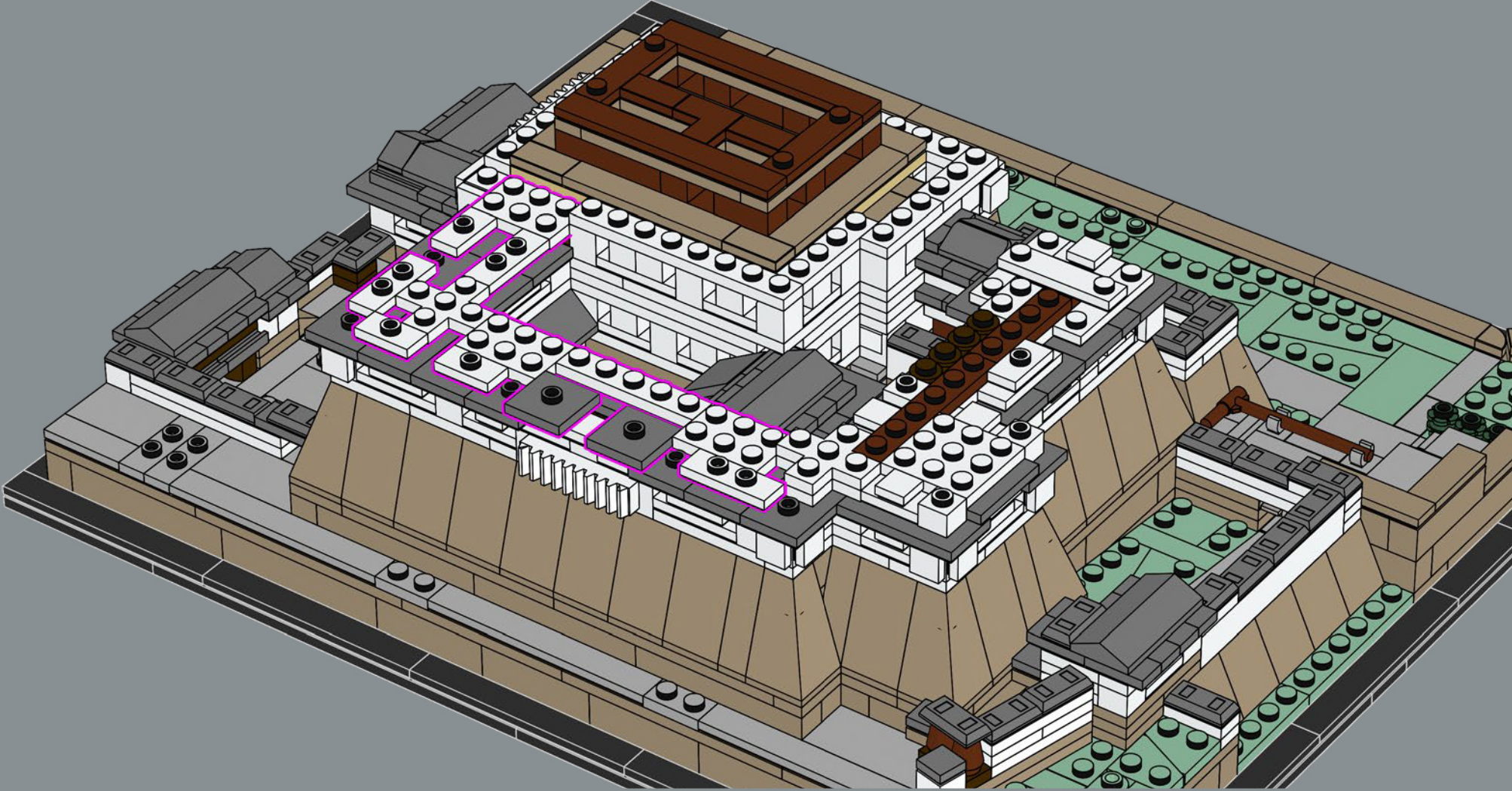



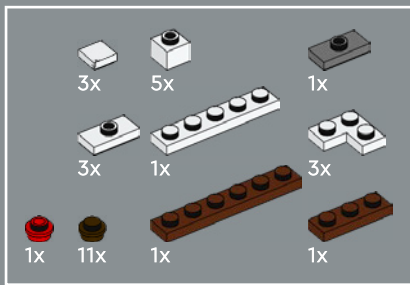

215

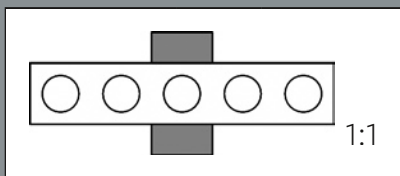
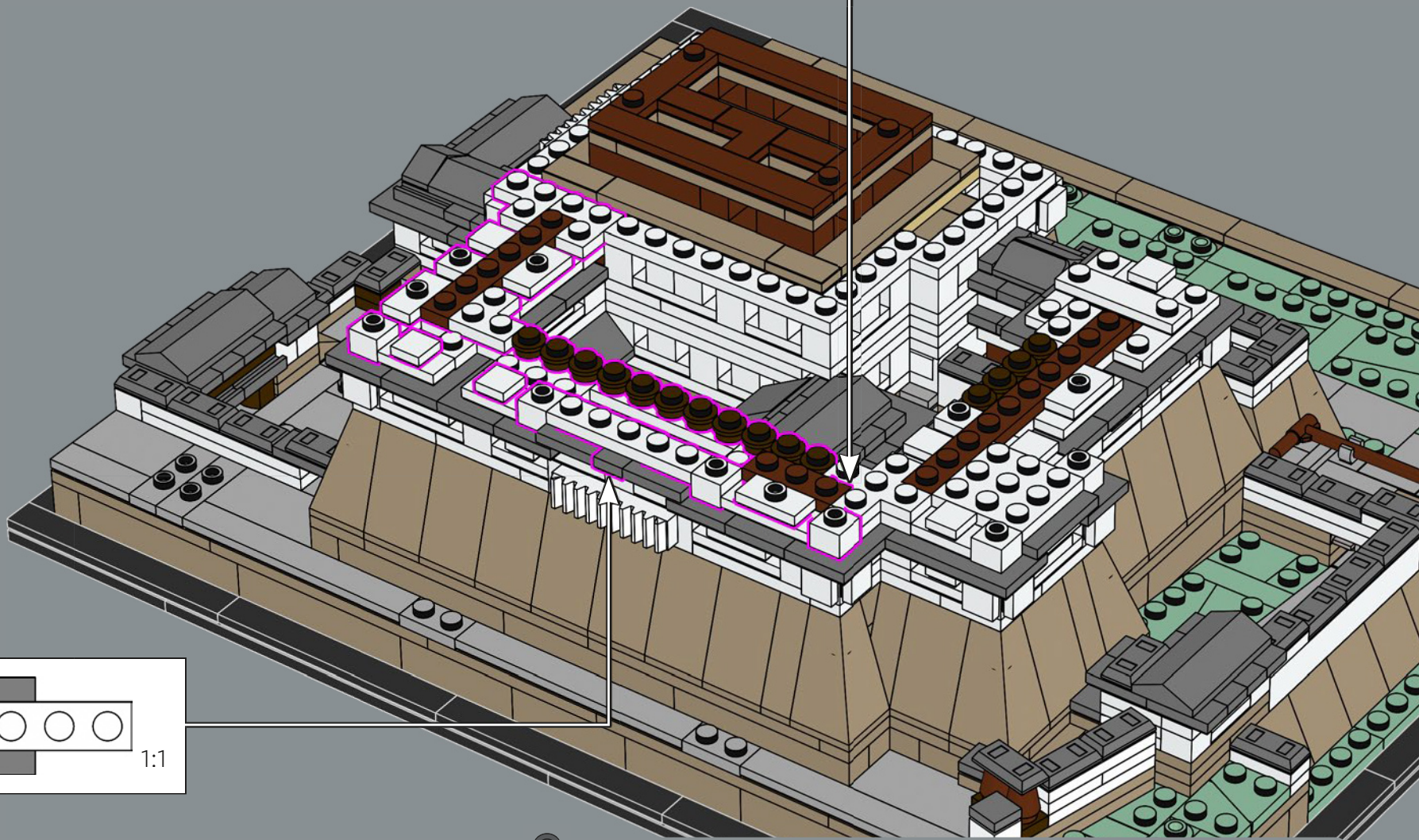
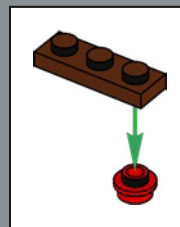



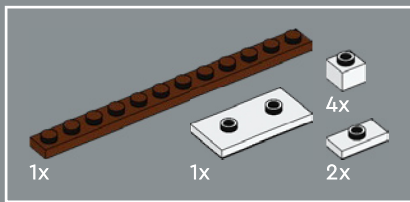

216

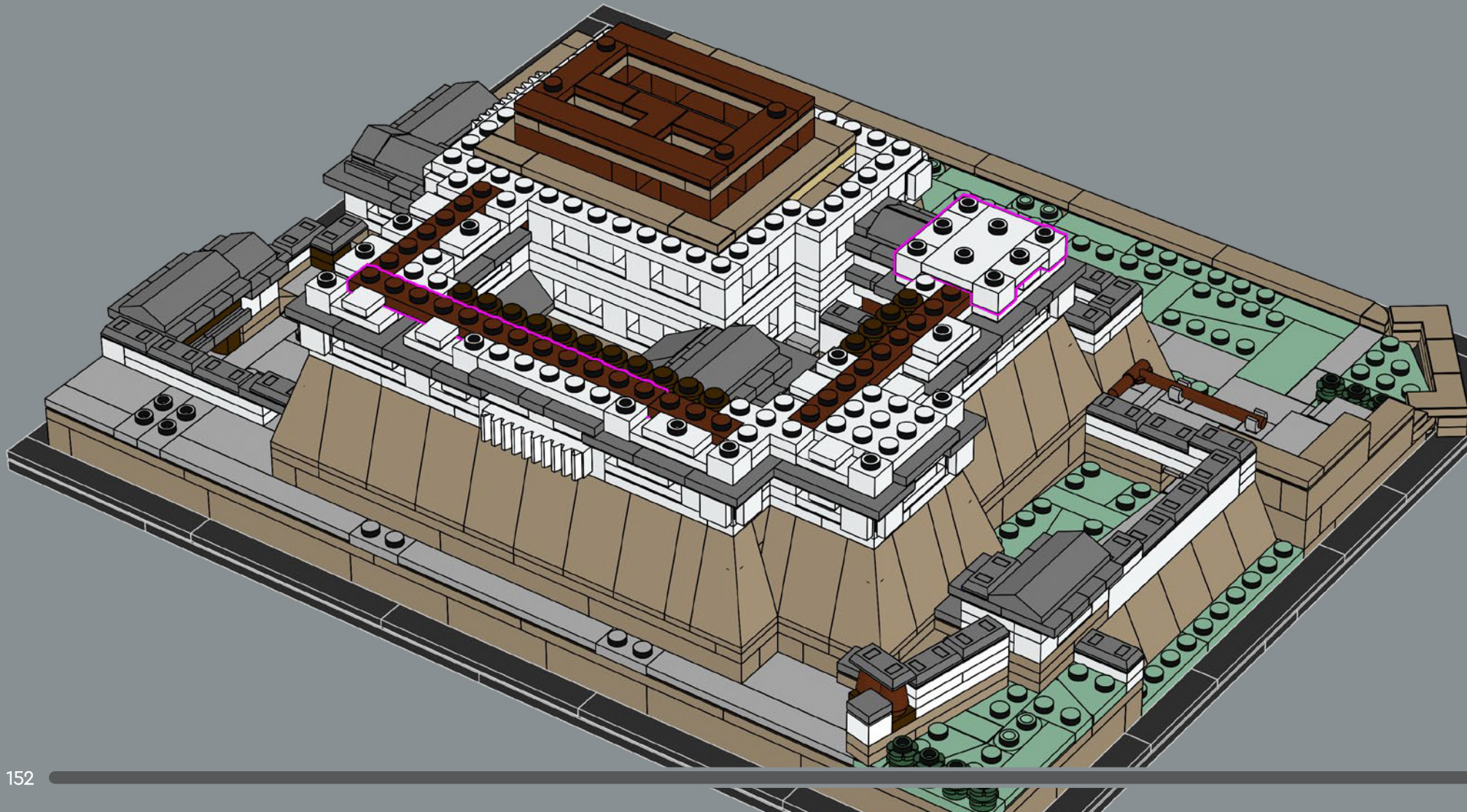



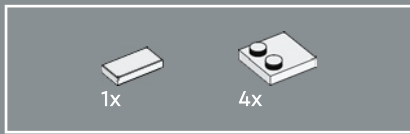

217

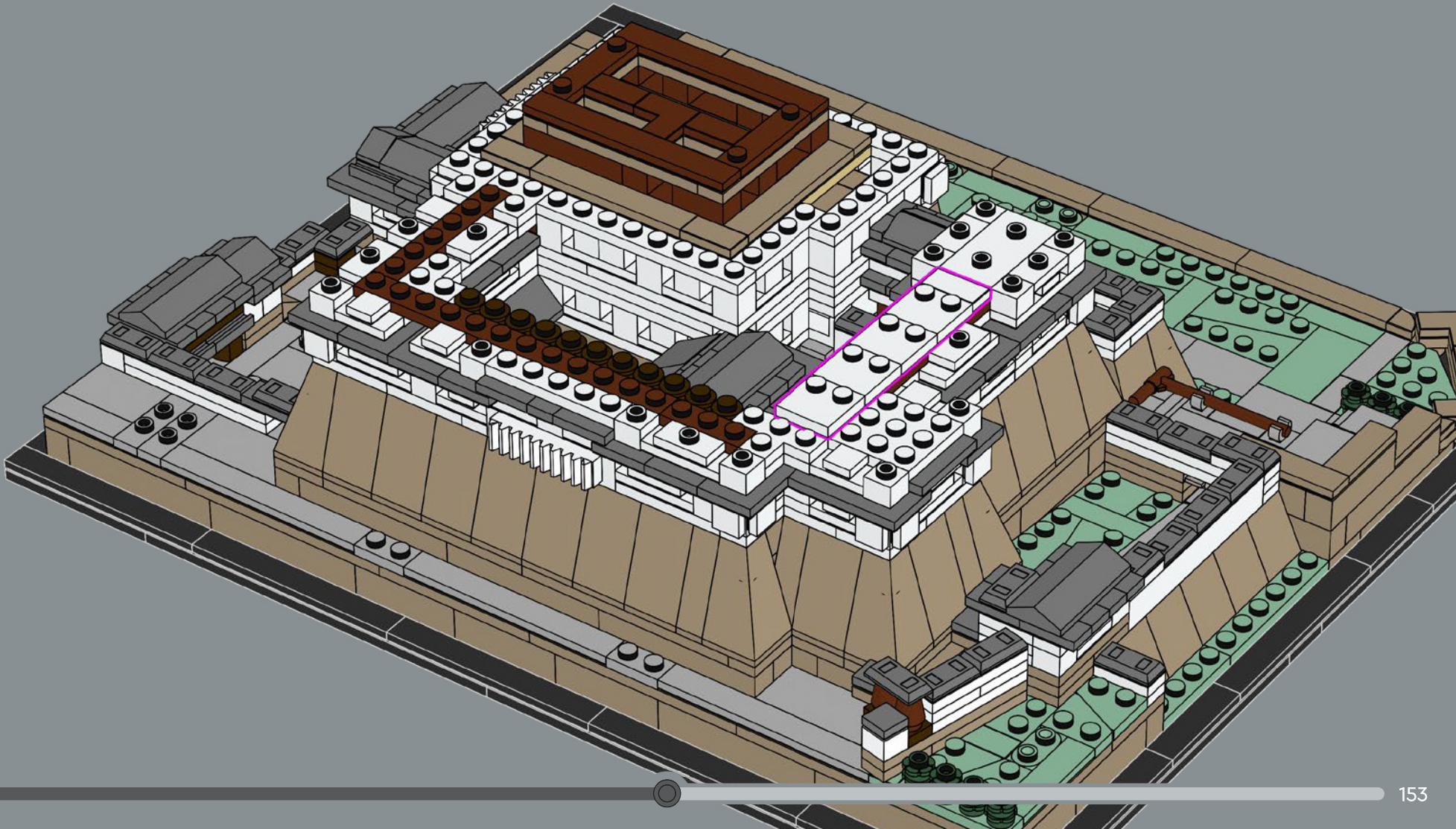



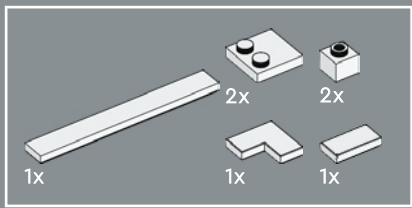

218

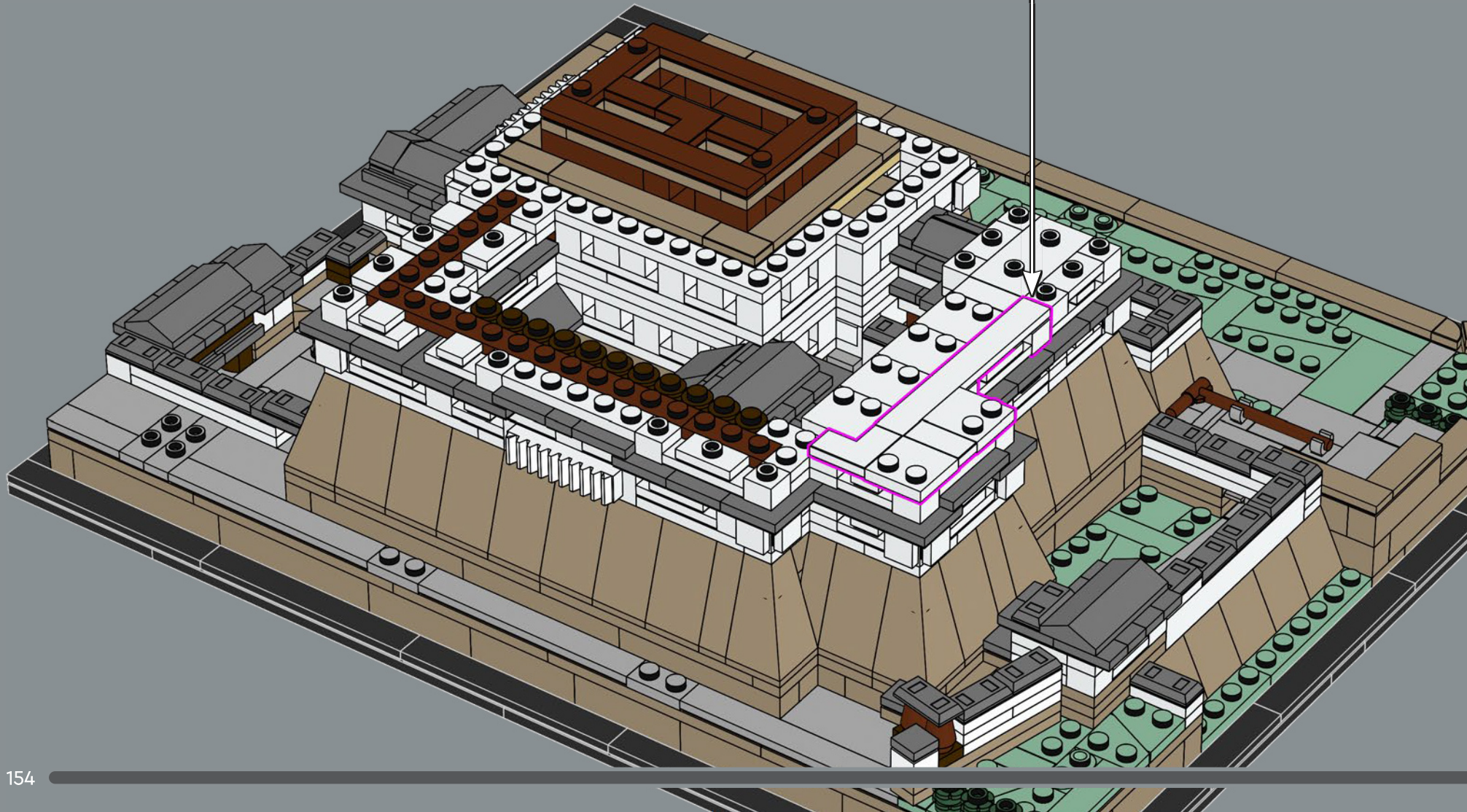
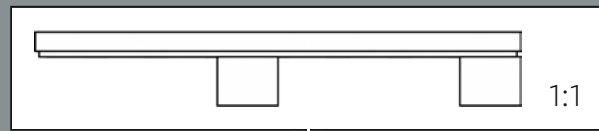



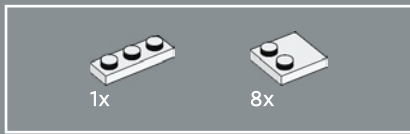

219

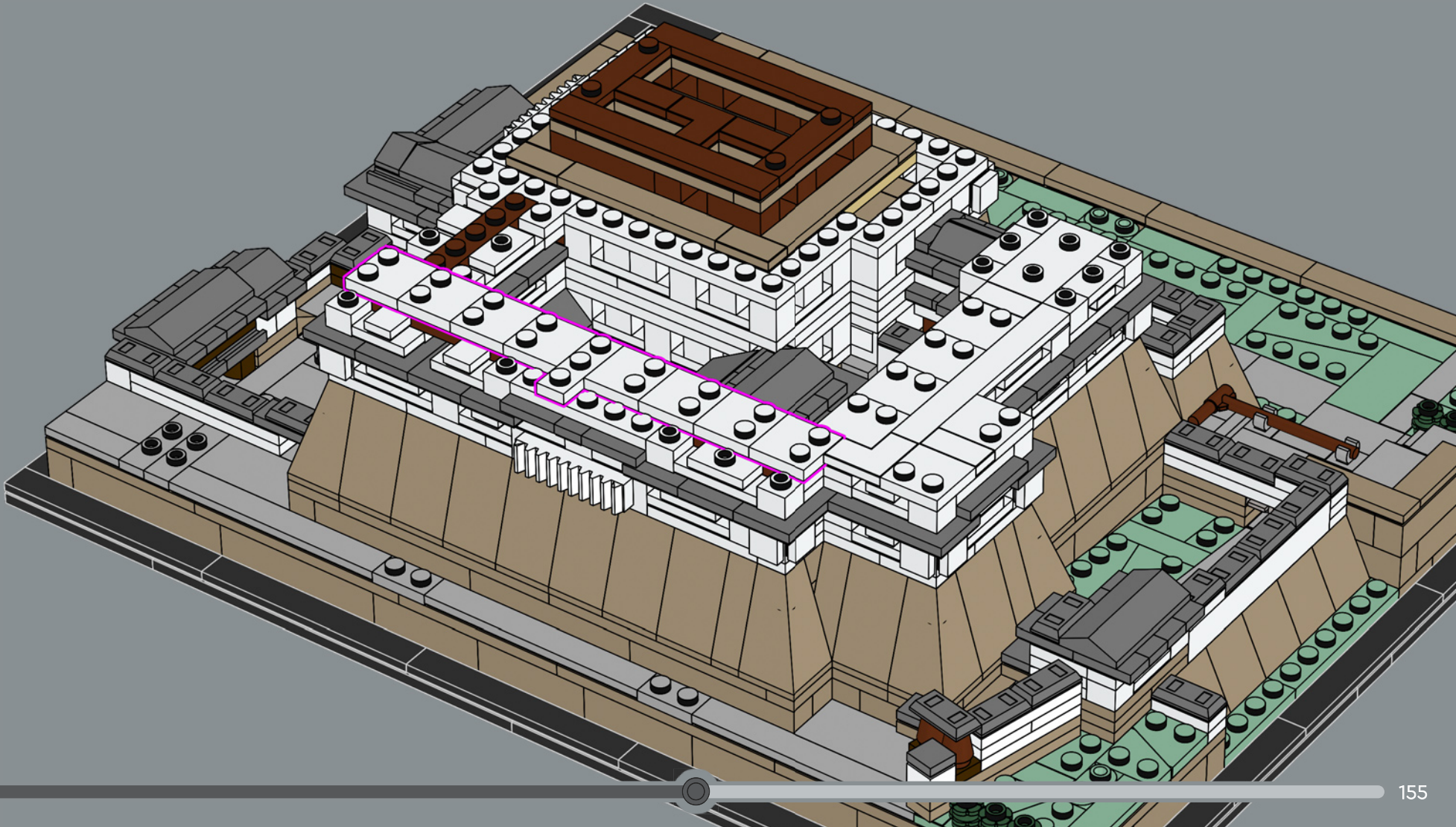



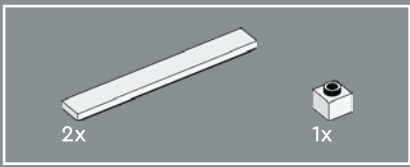

220

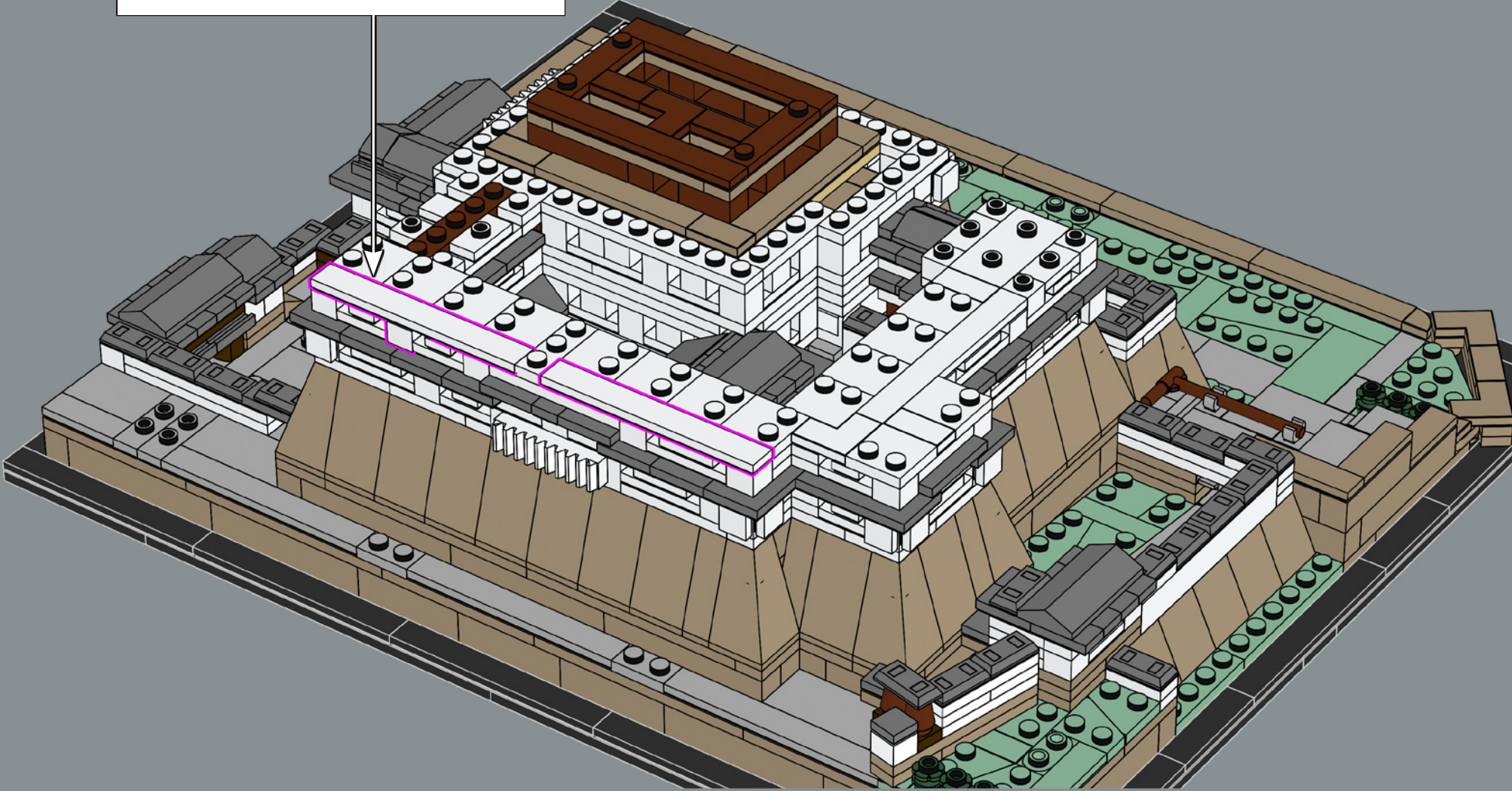



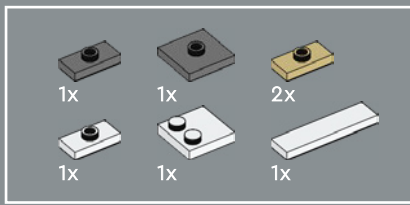

221

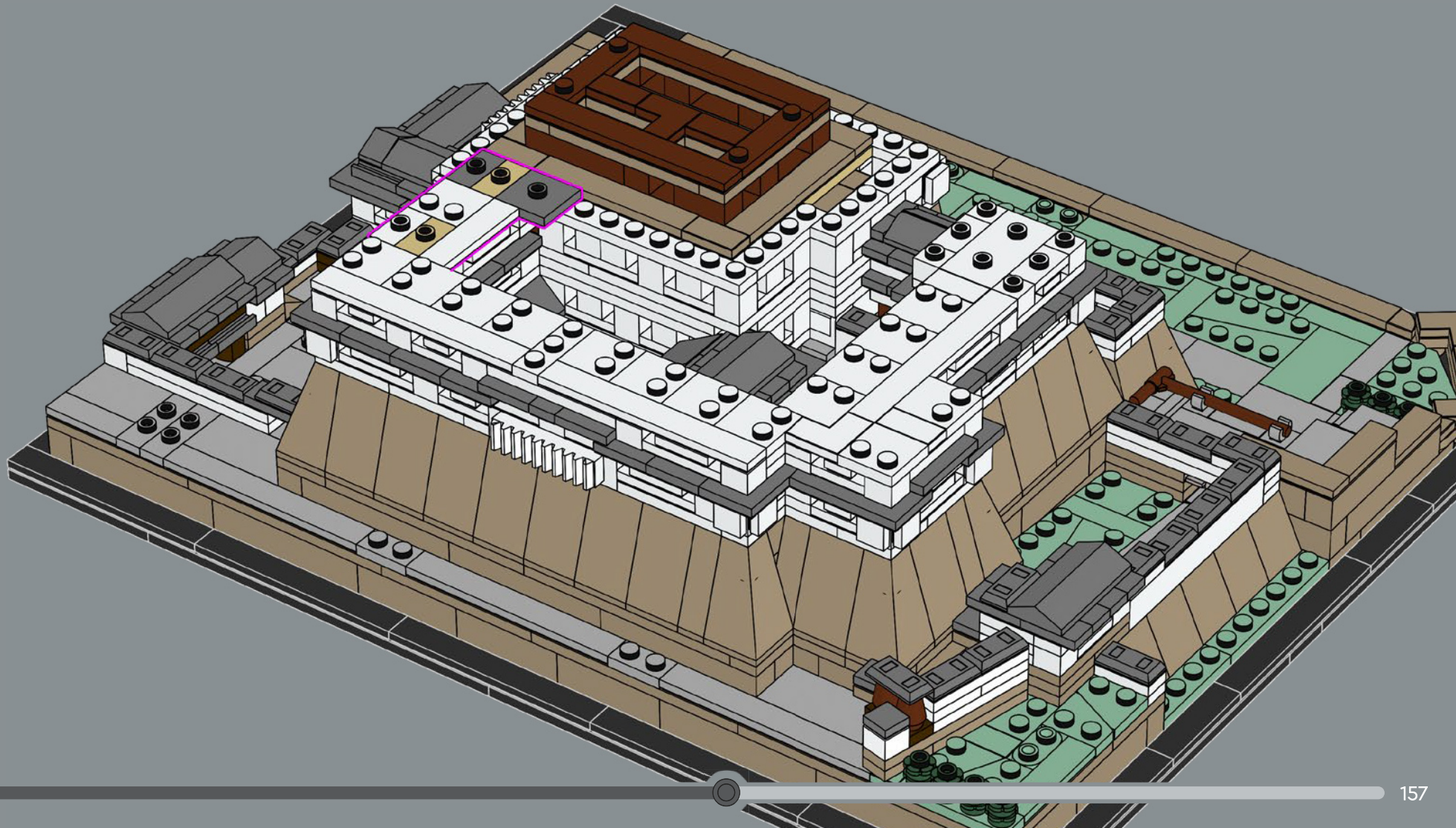



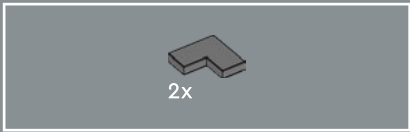

222

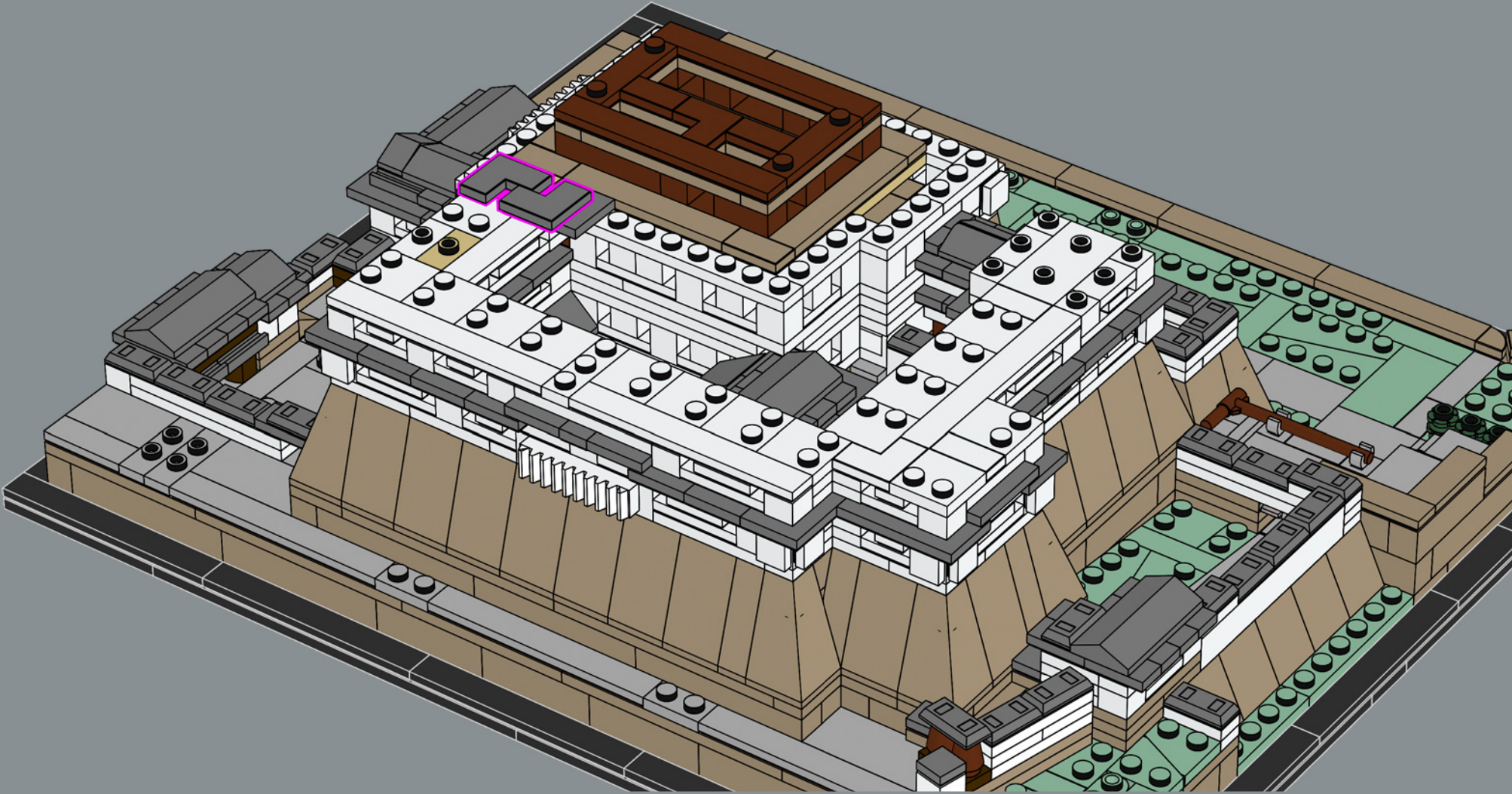



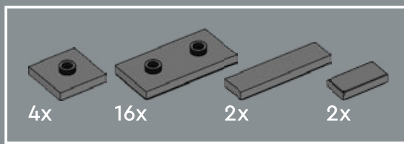

223

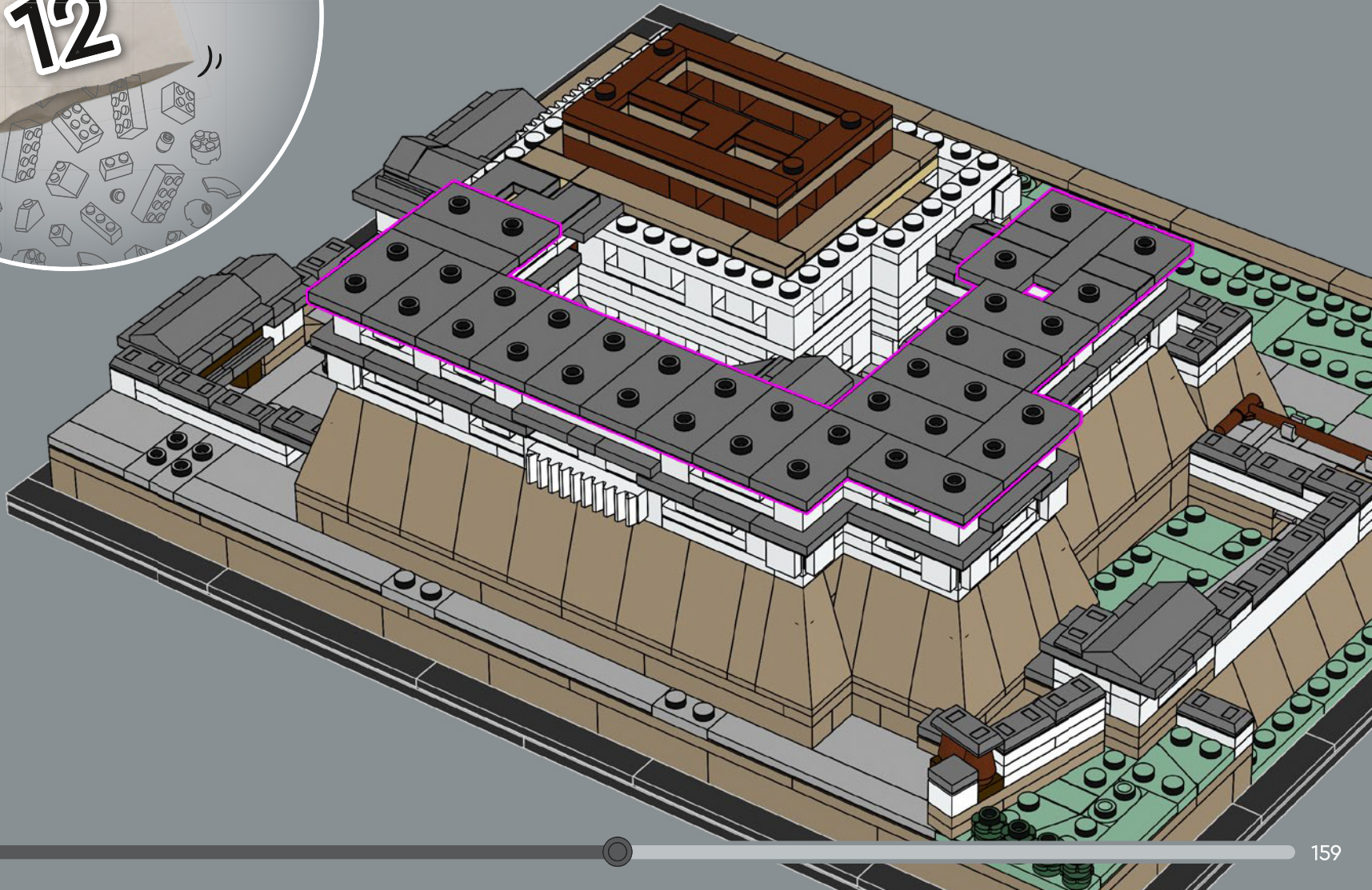



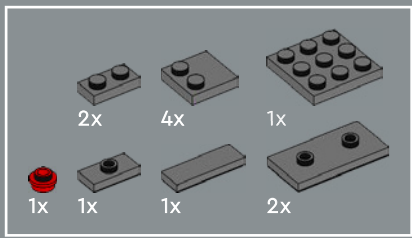

224

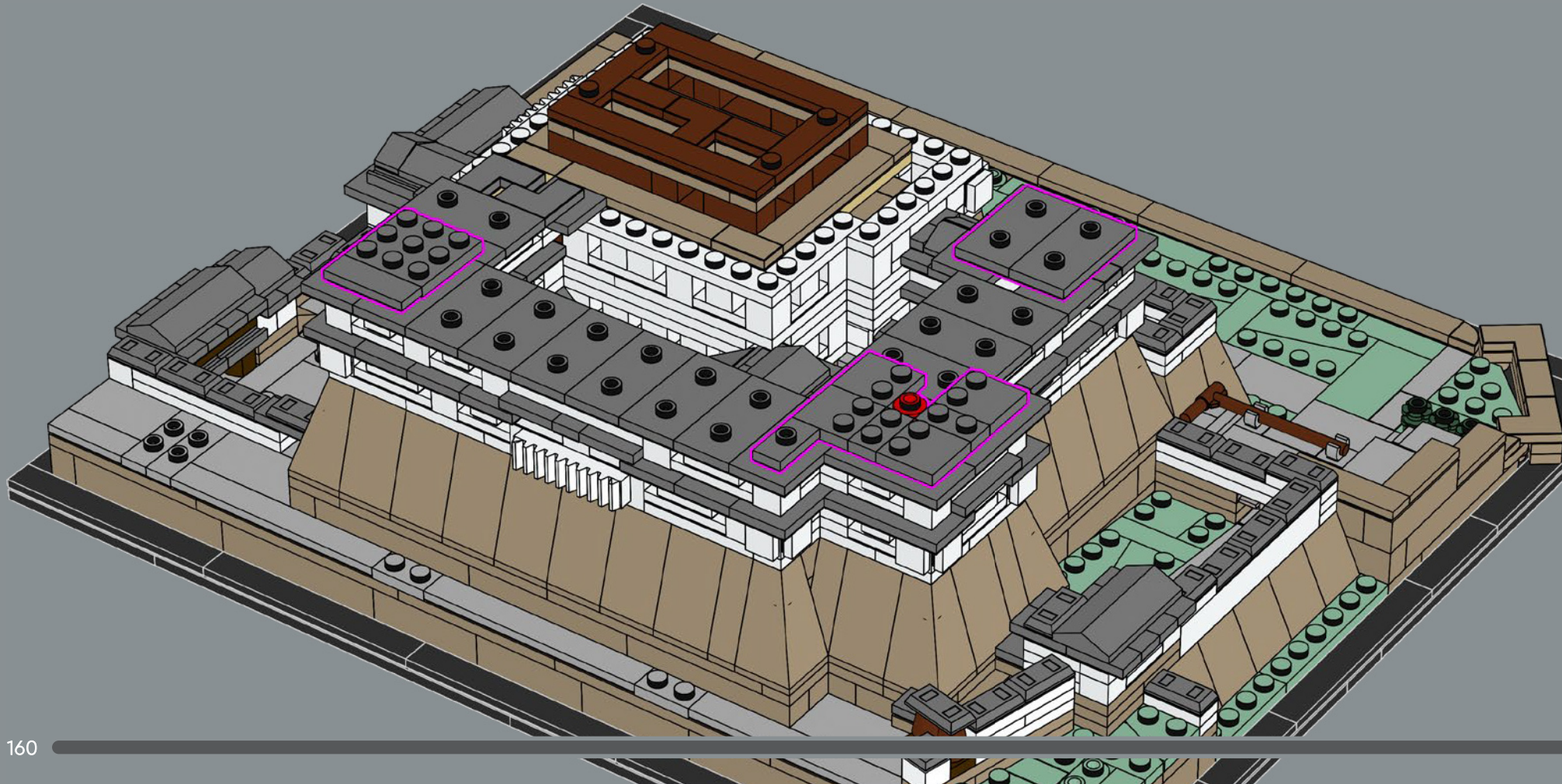



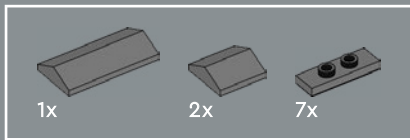

225

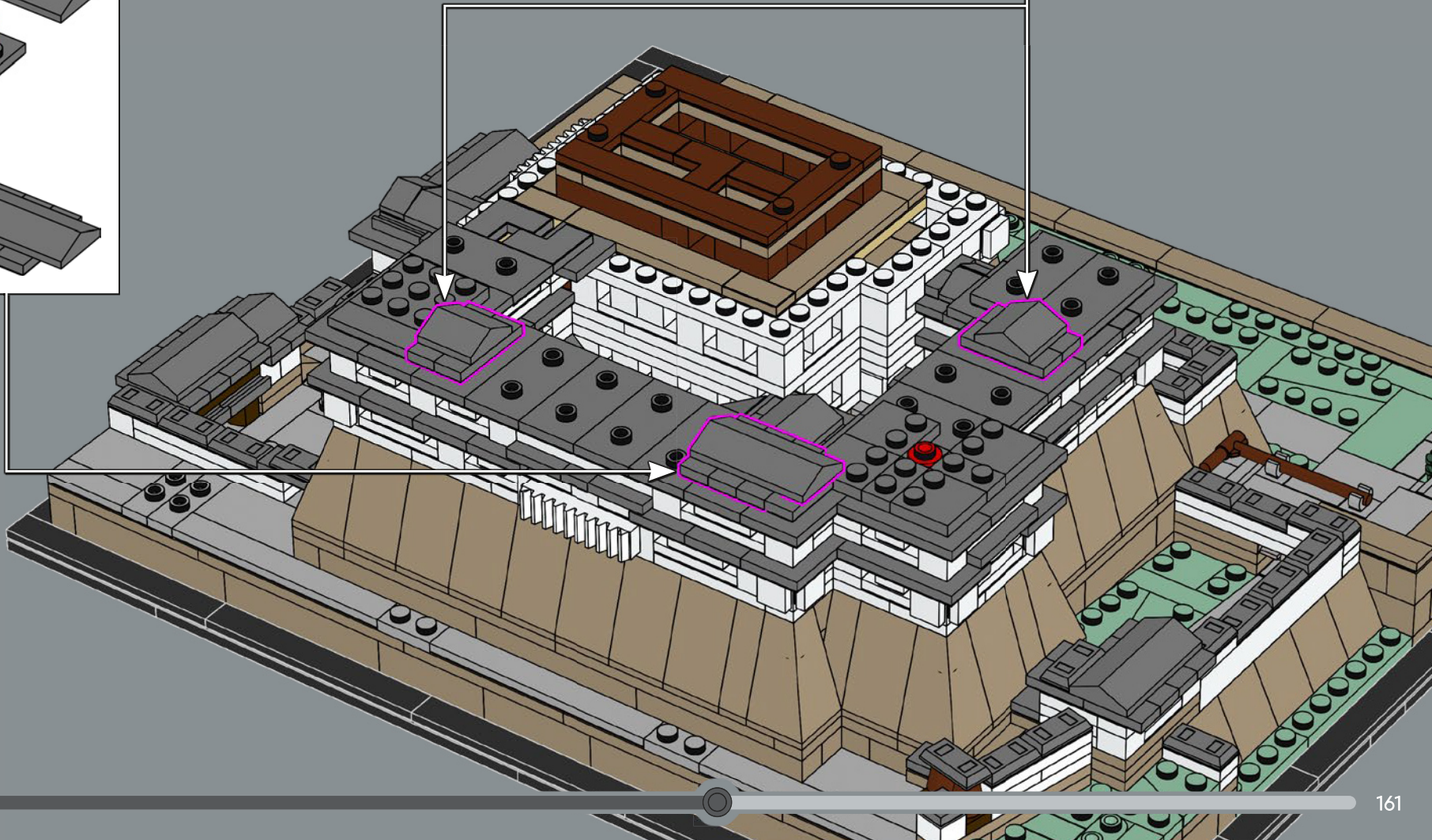
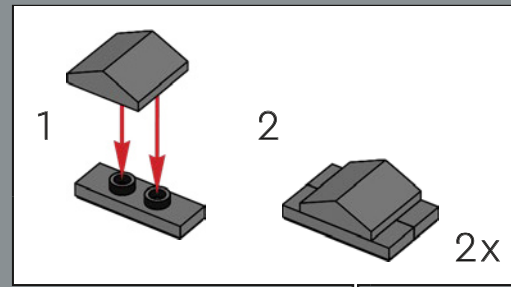
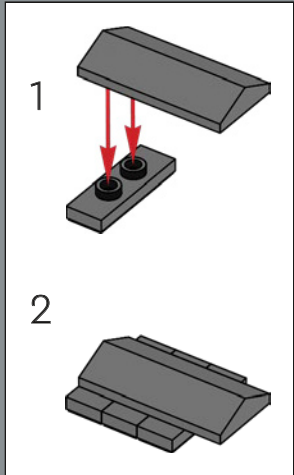



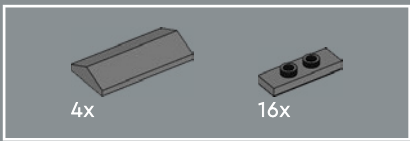

226

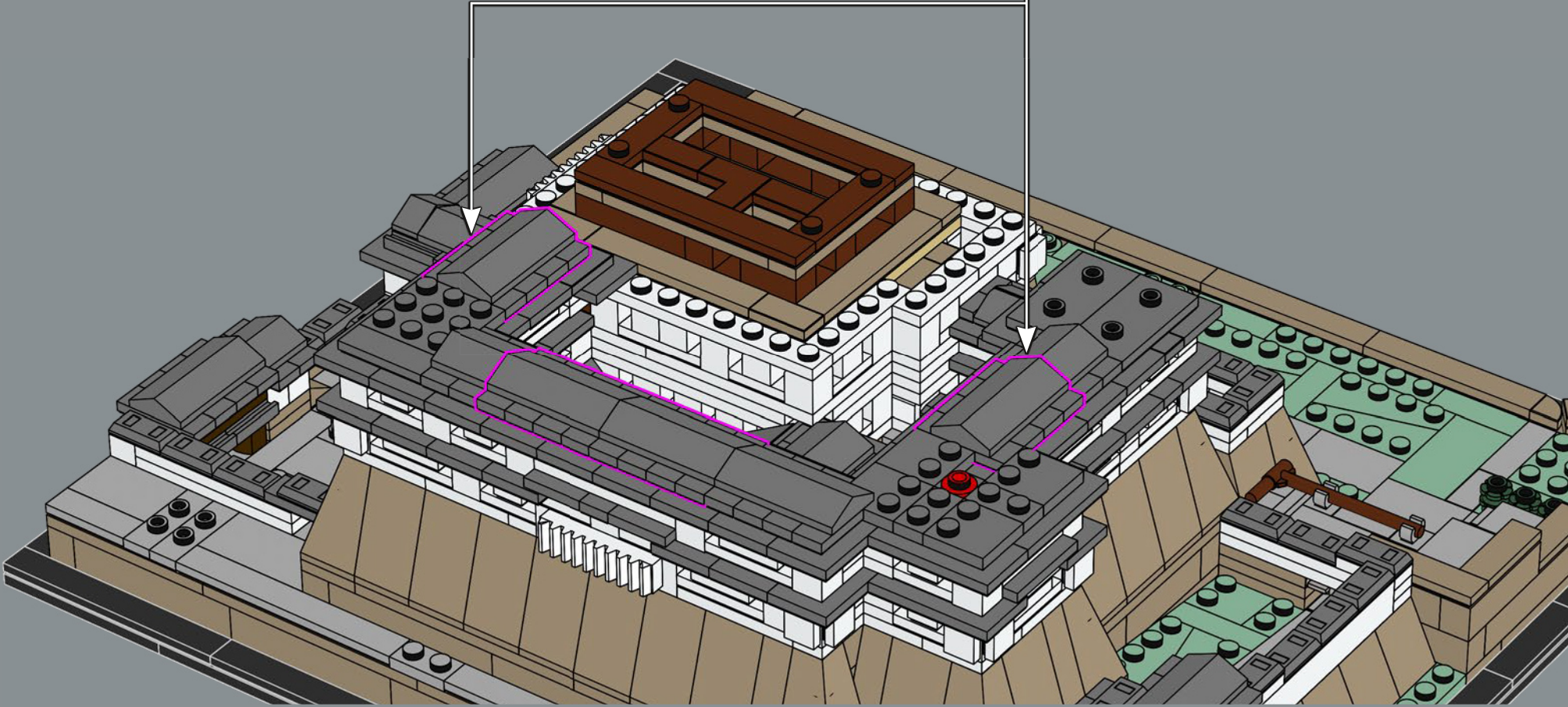
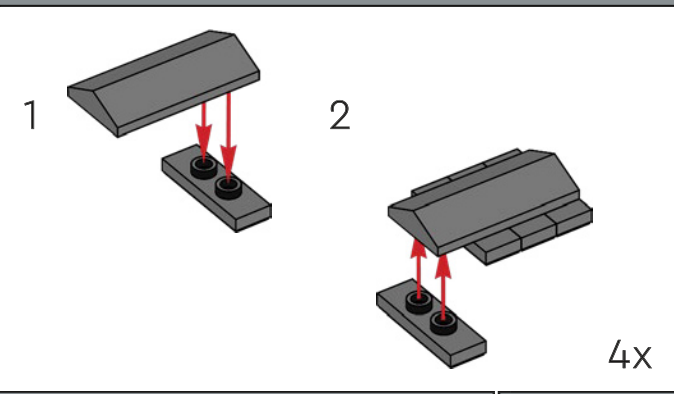



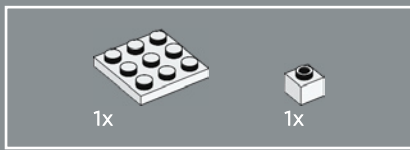

227

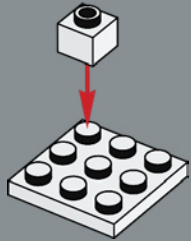

228

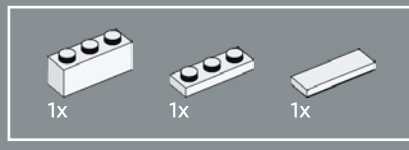
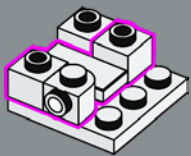

229

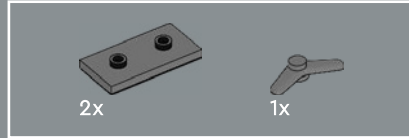
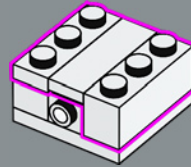

230

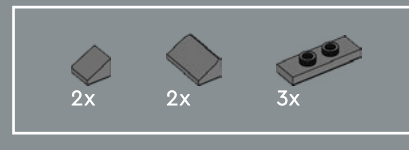
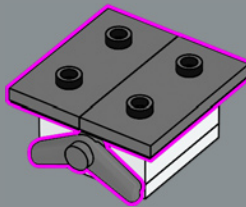

231

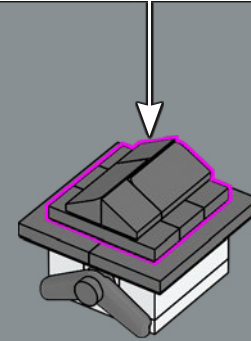
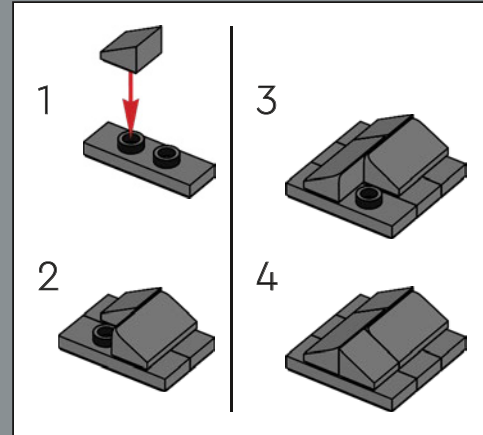

Da das Dach jahrelang der Witterung ausgesetzt ist, verschmutzt der weiße Ton zunehmend, sodass sich das Erscheinungsbild des Daches allmählich verändert.

232

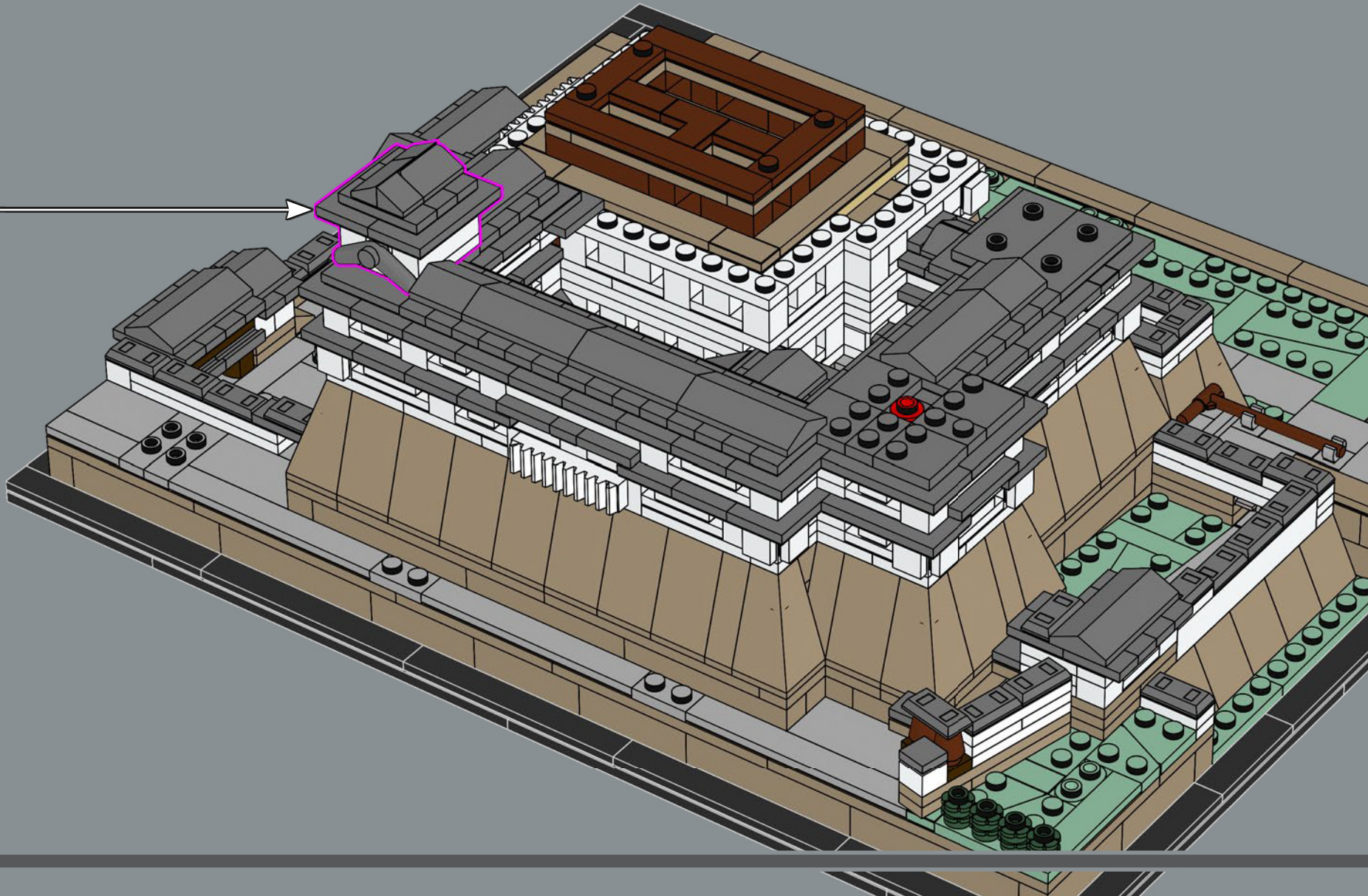



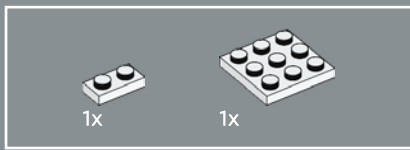

233

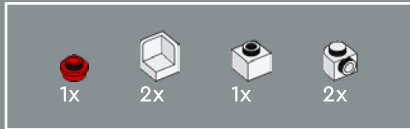
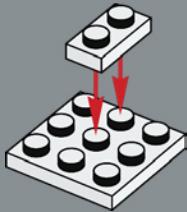

234

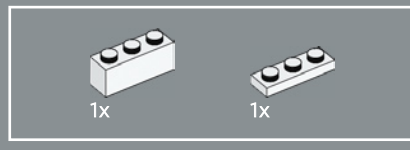
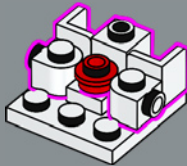

235

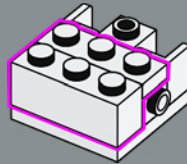

236

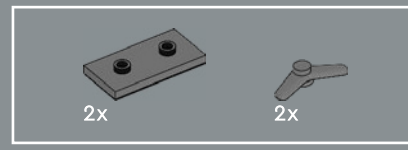
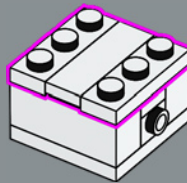

237

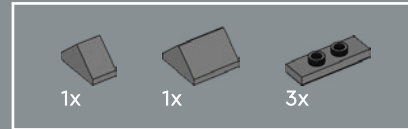
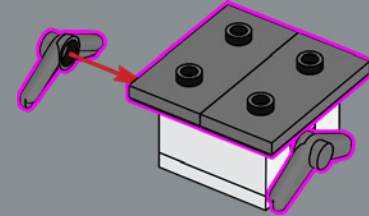

238

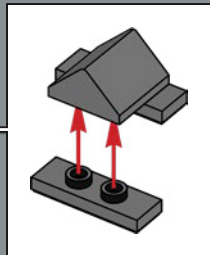
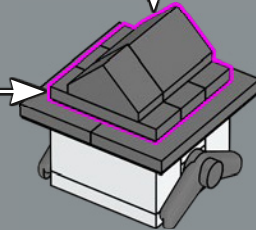
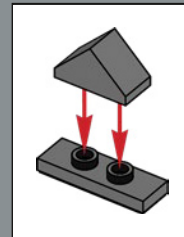

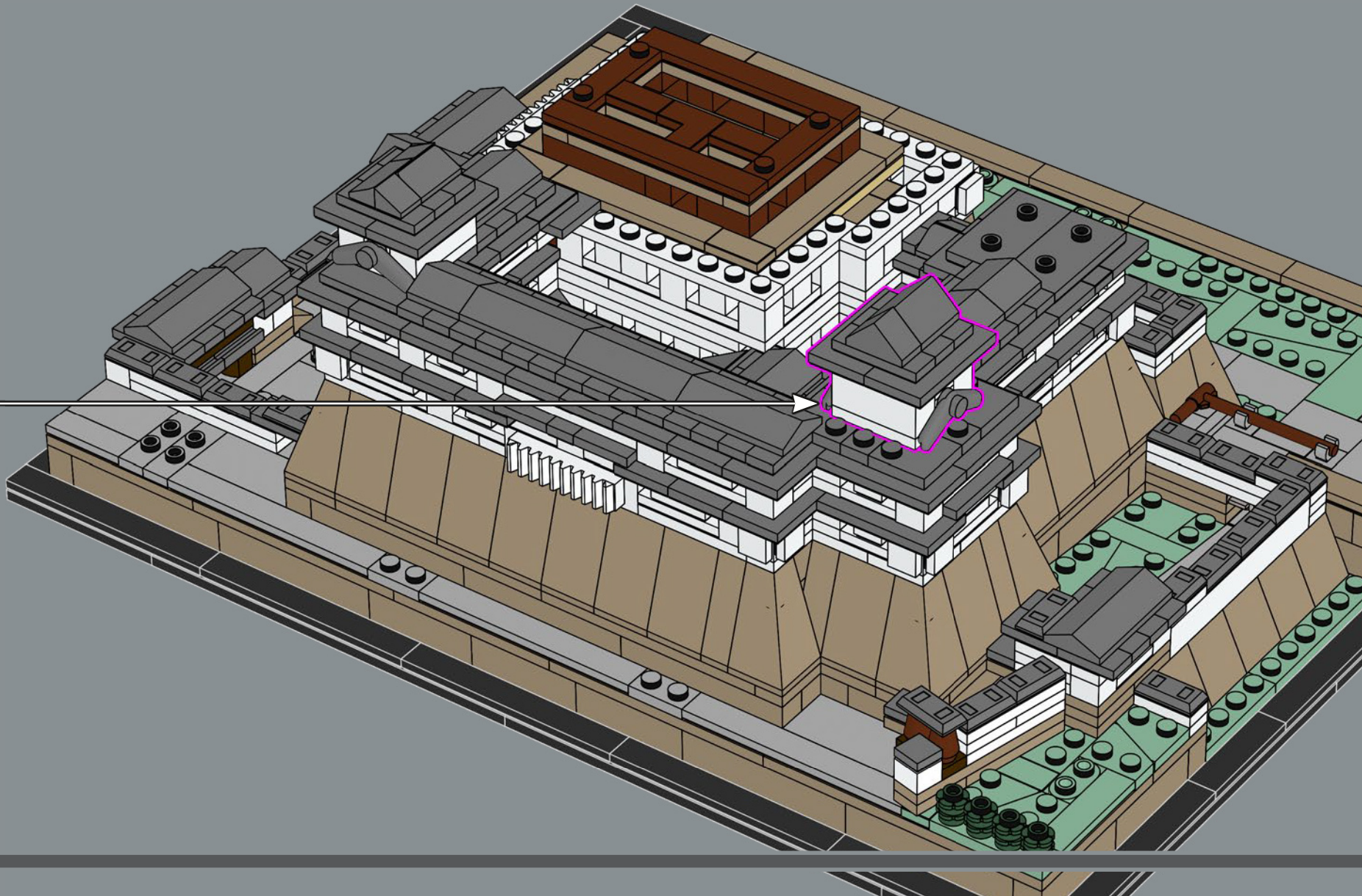





240

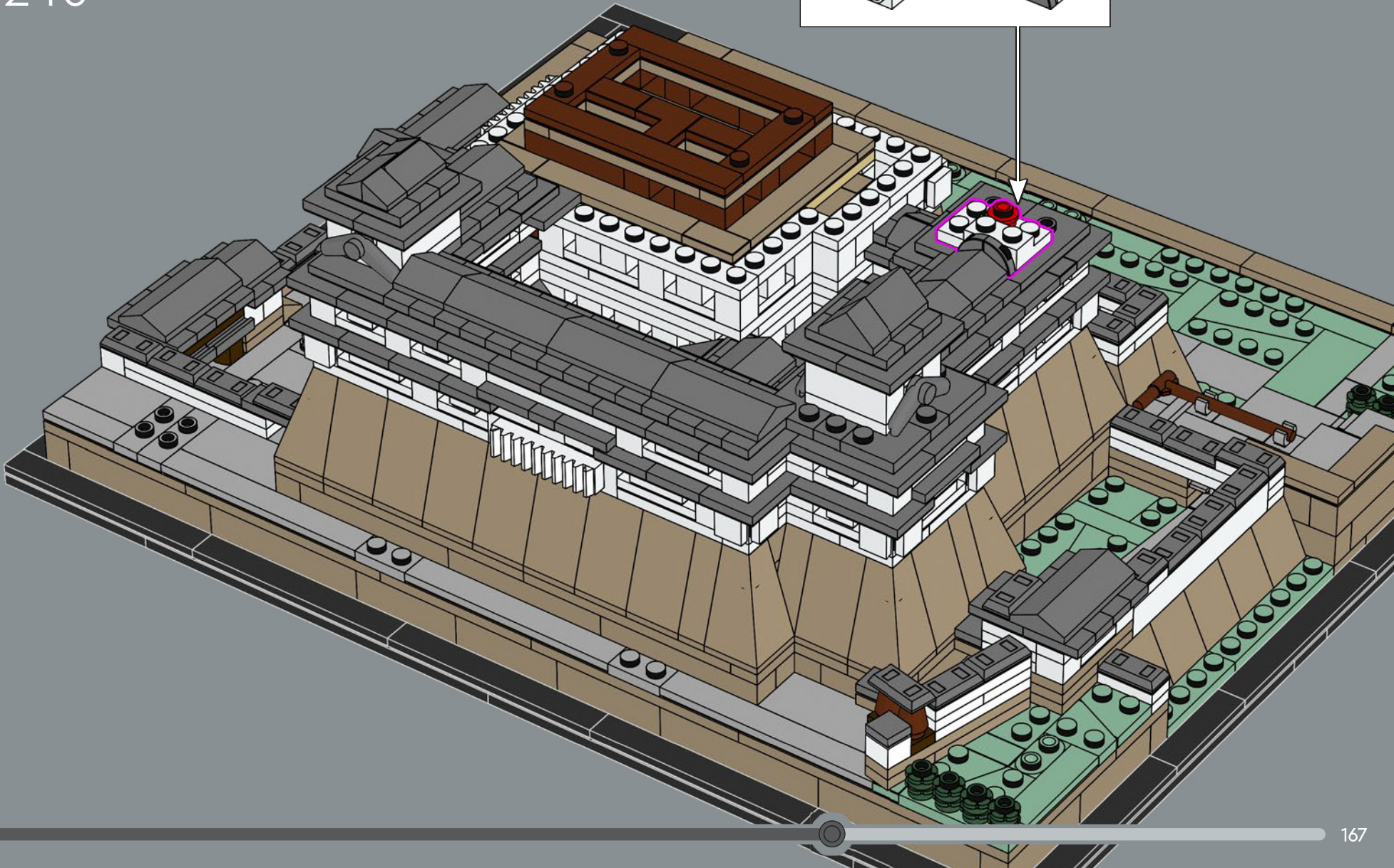
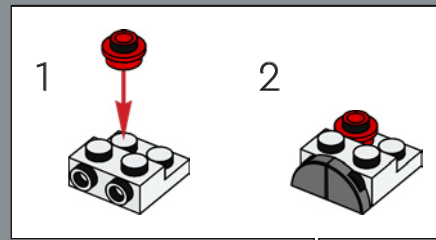



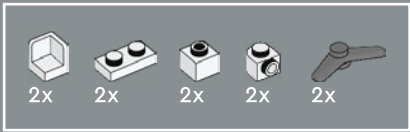

241

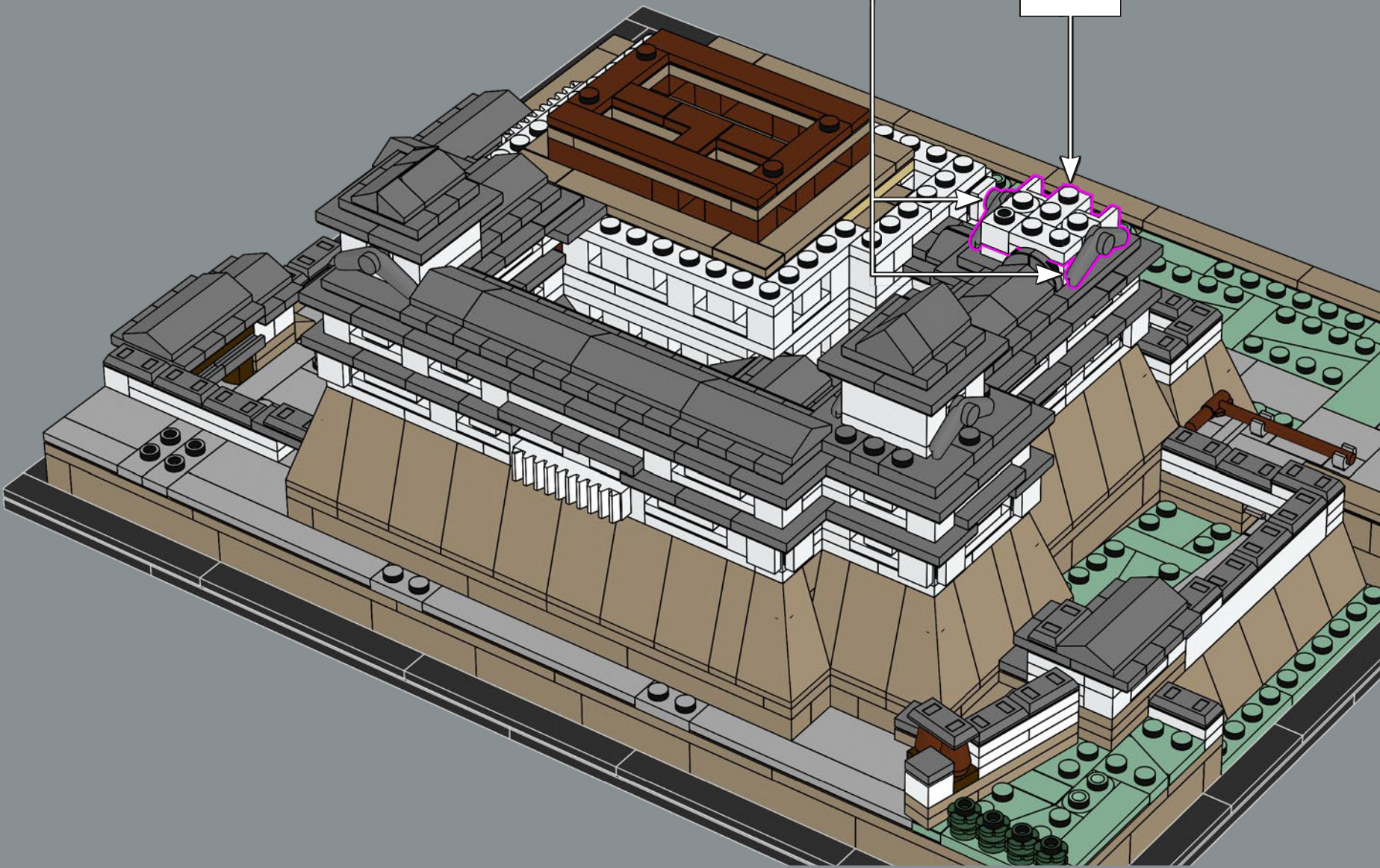
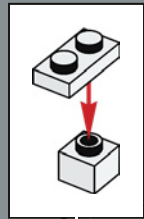
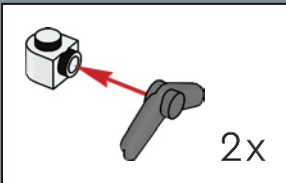



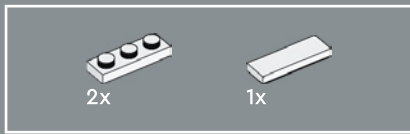

242

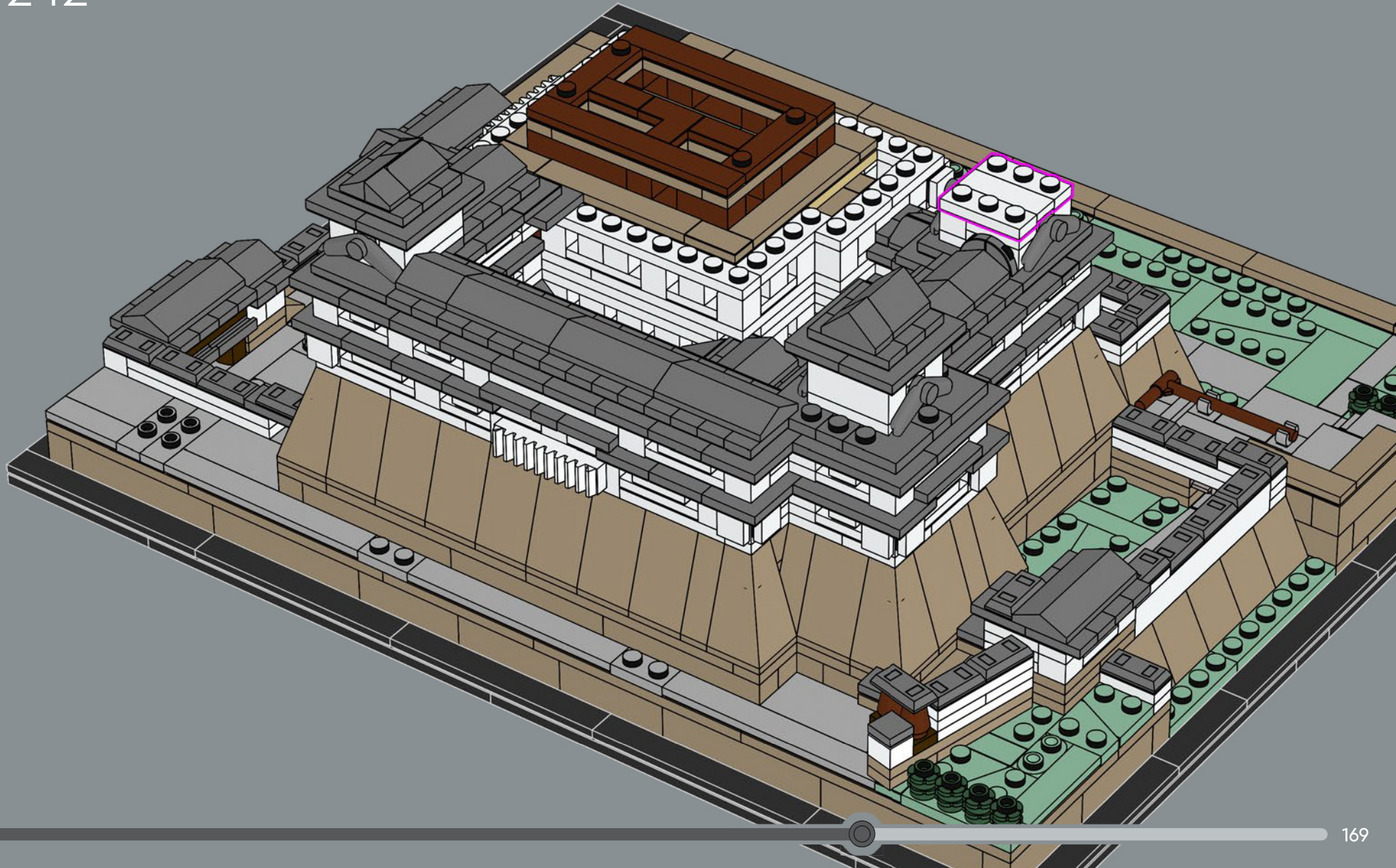



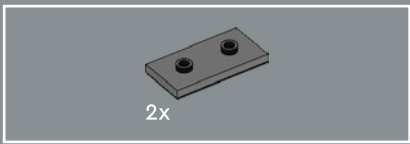

243

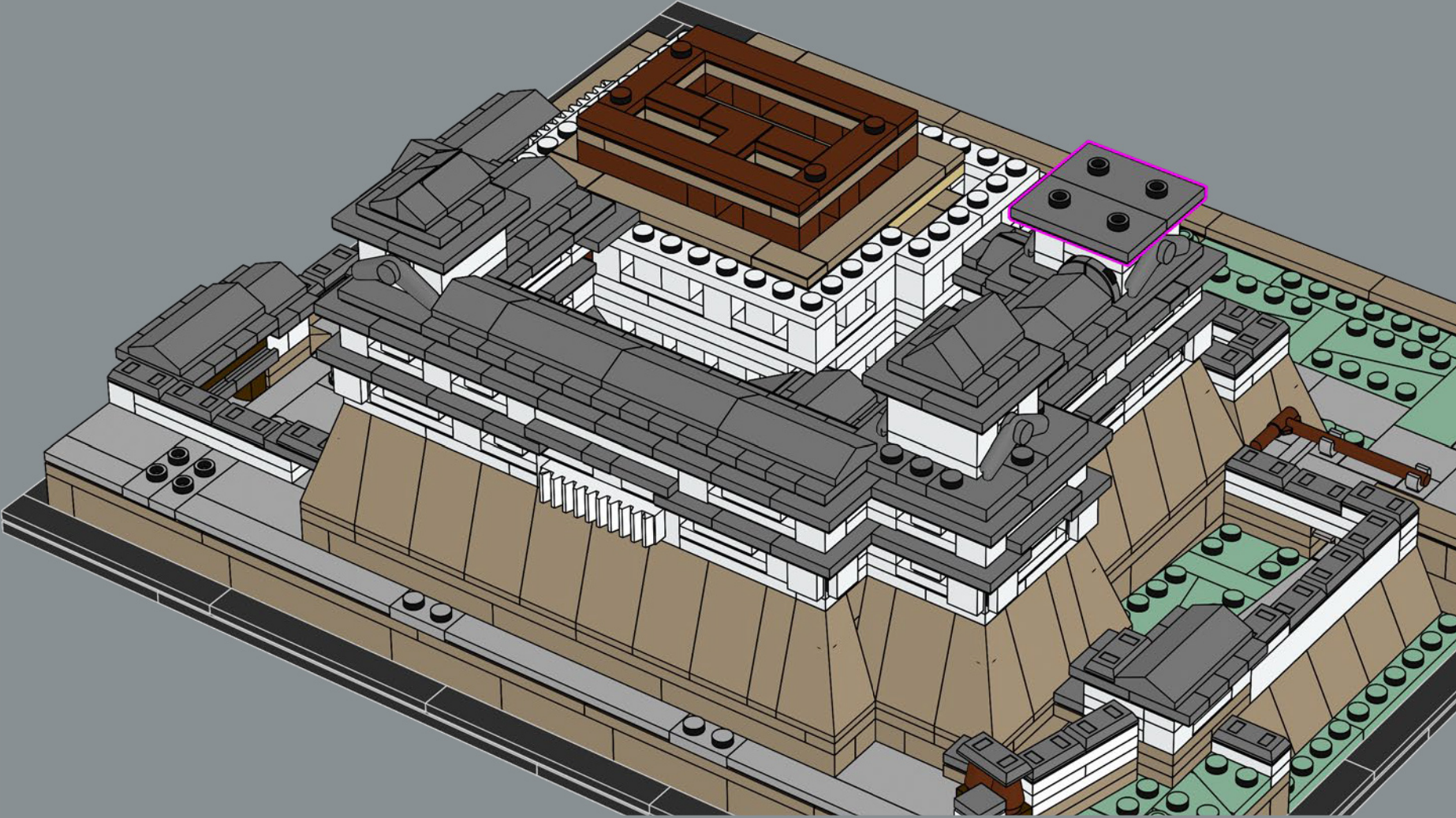



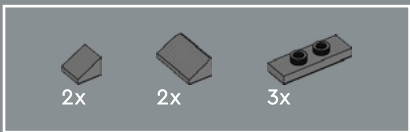

244

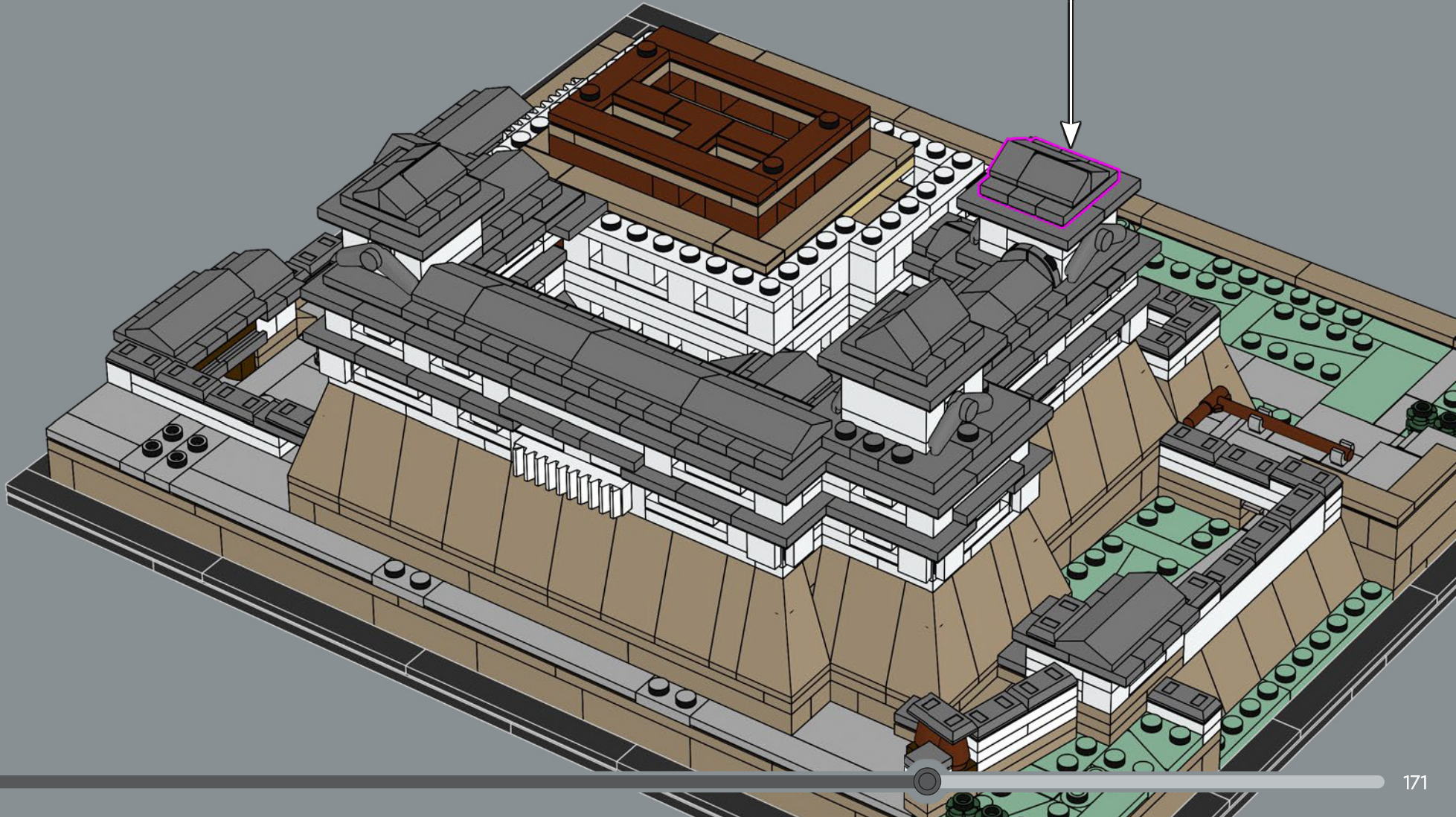
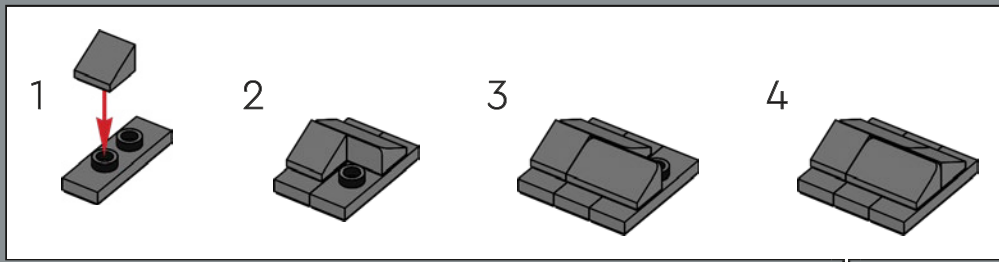



Das neue 2x2 Eckbogenelement ist erst das zweite NEUE Element, das für ein LEGO® Architecture Set genehmigt wurde. Das erste Teil war 2011 ein ähnliches 3x3 Element im Robie House (21010).

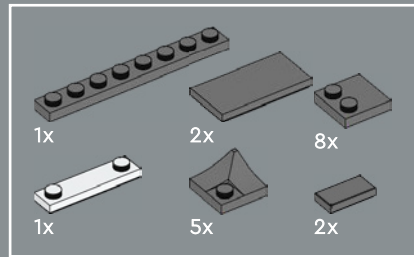

245

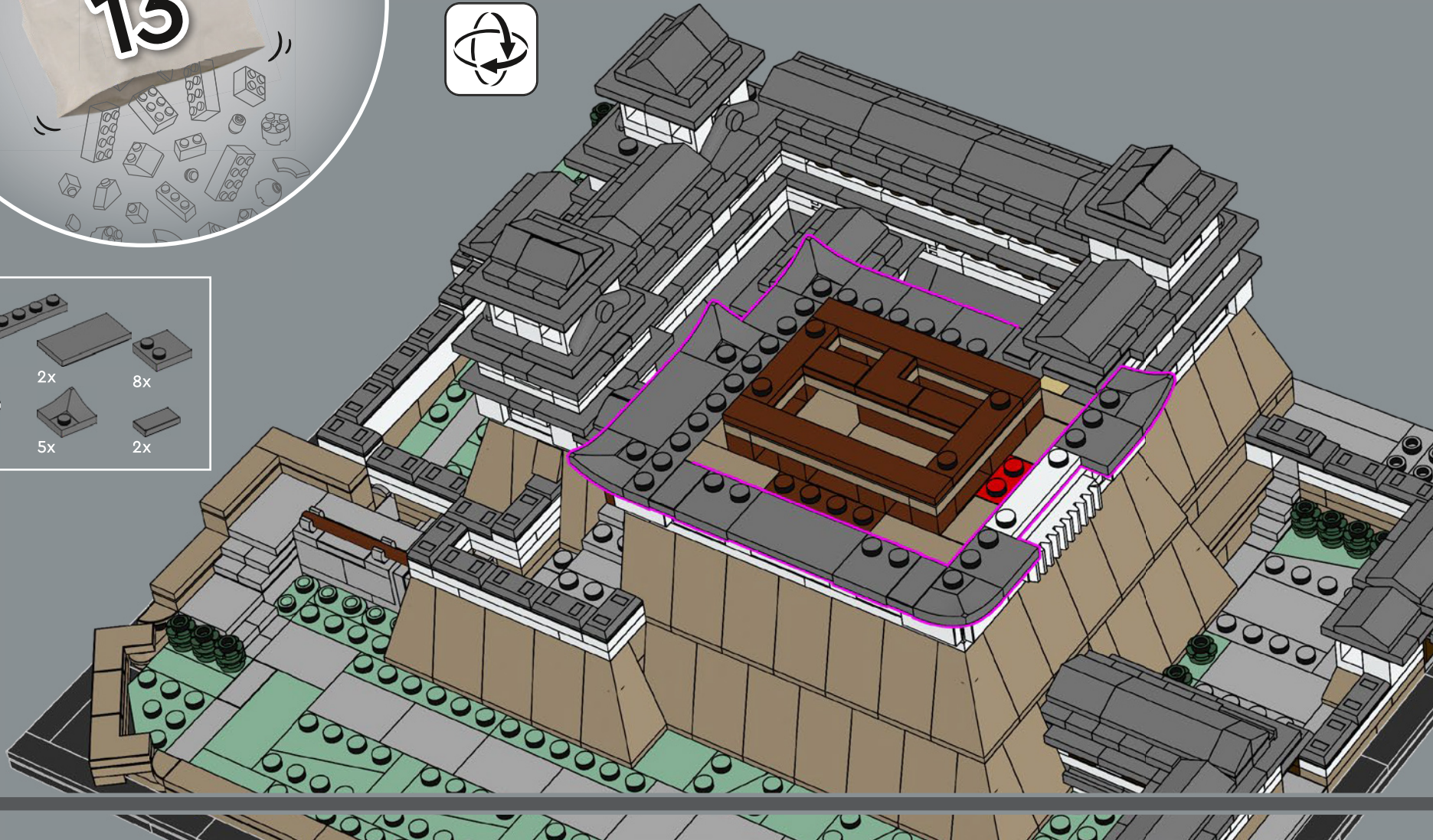



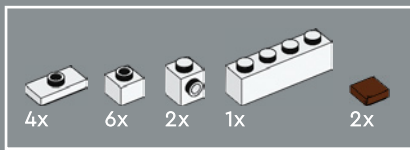

246

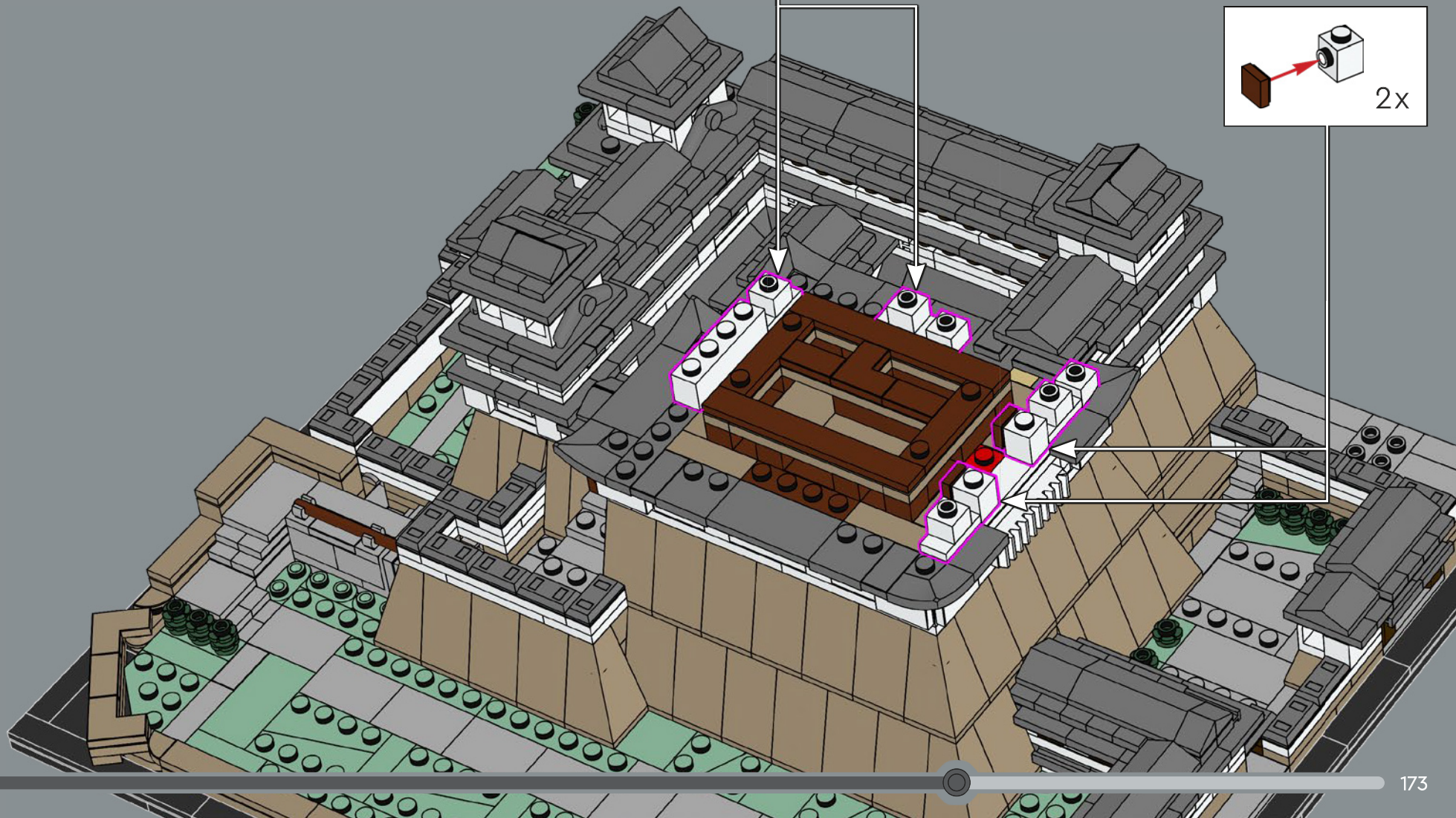
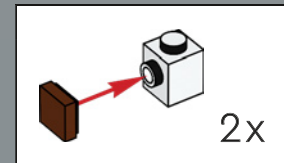
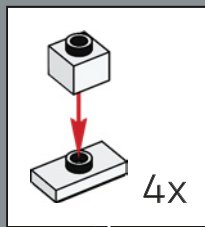



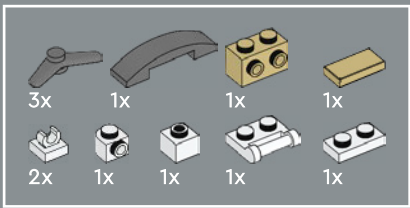

247

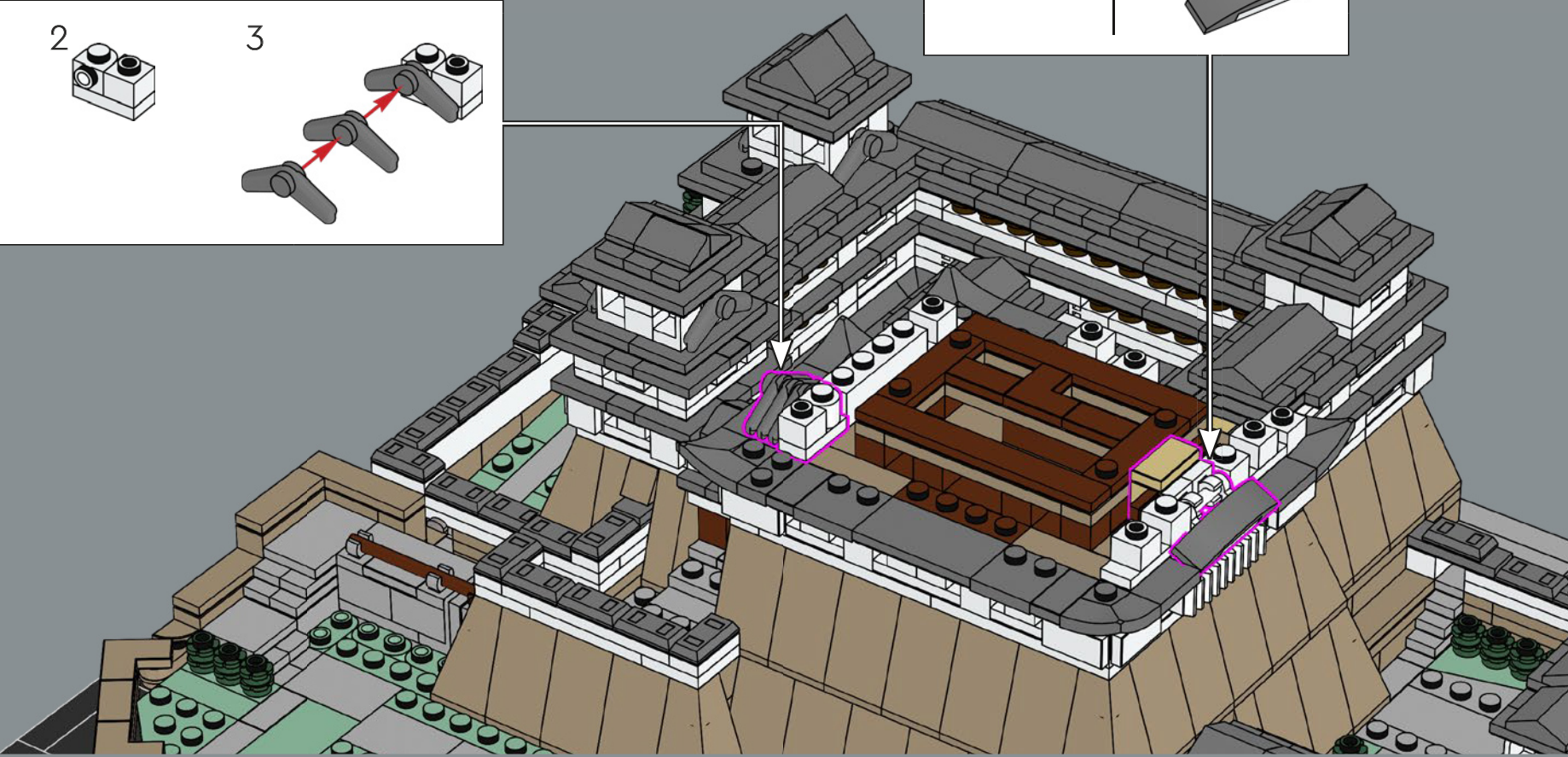
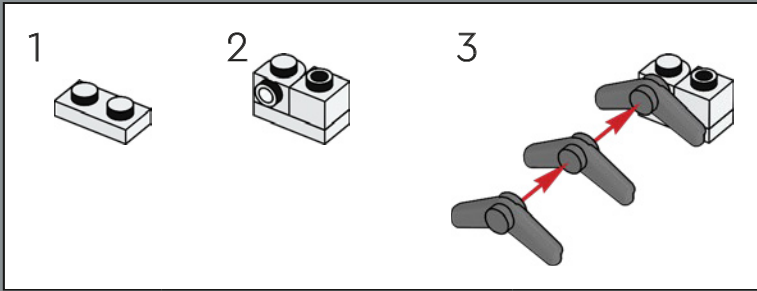
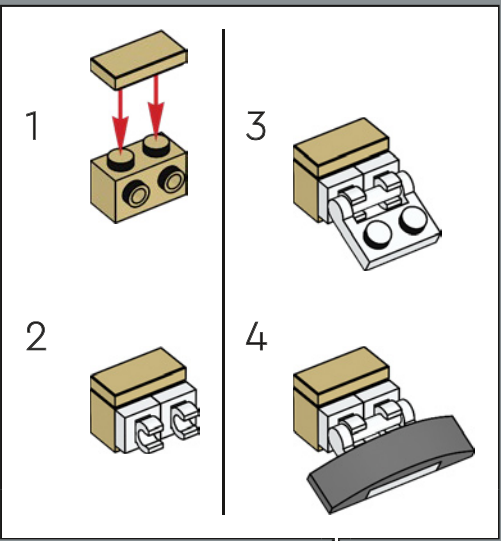



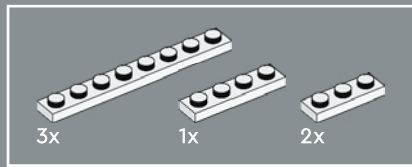

248

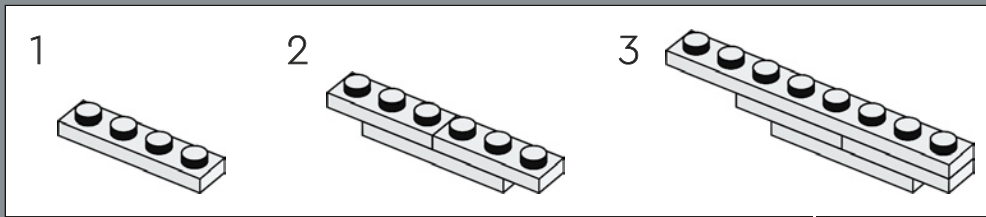



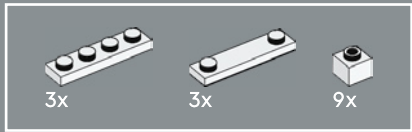
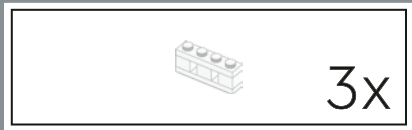

249

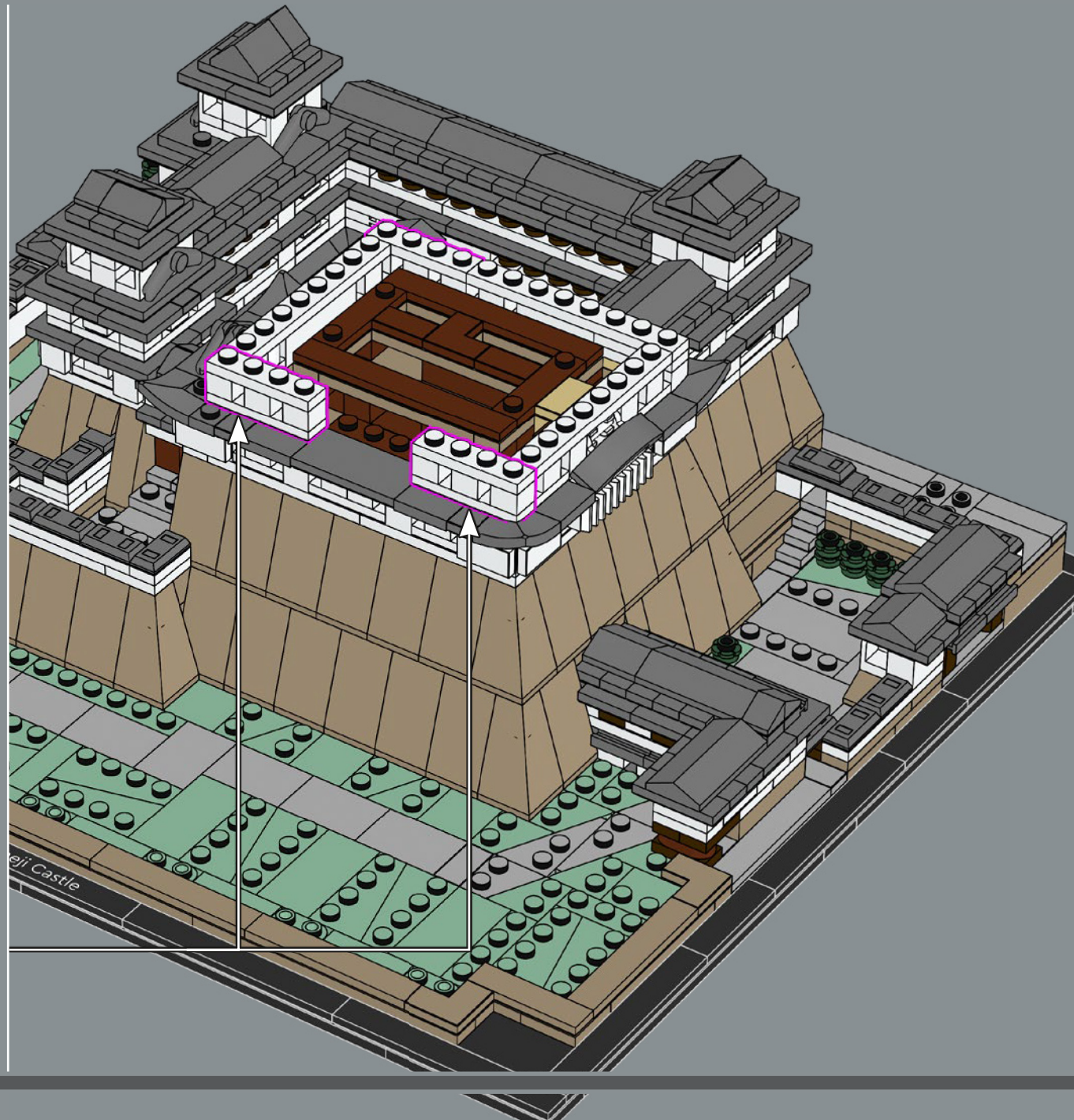
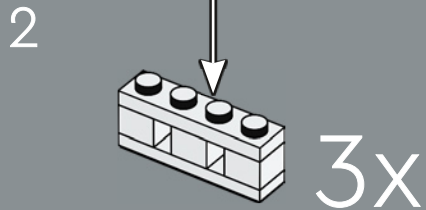
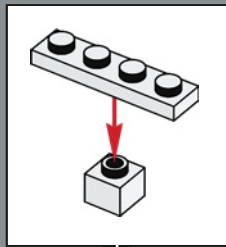
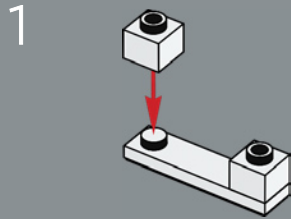



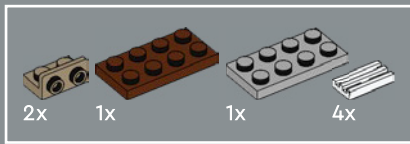

250

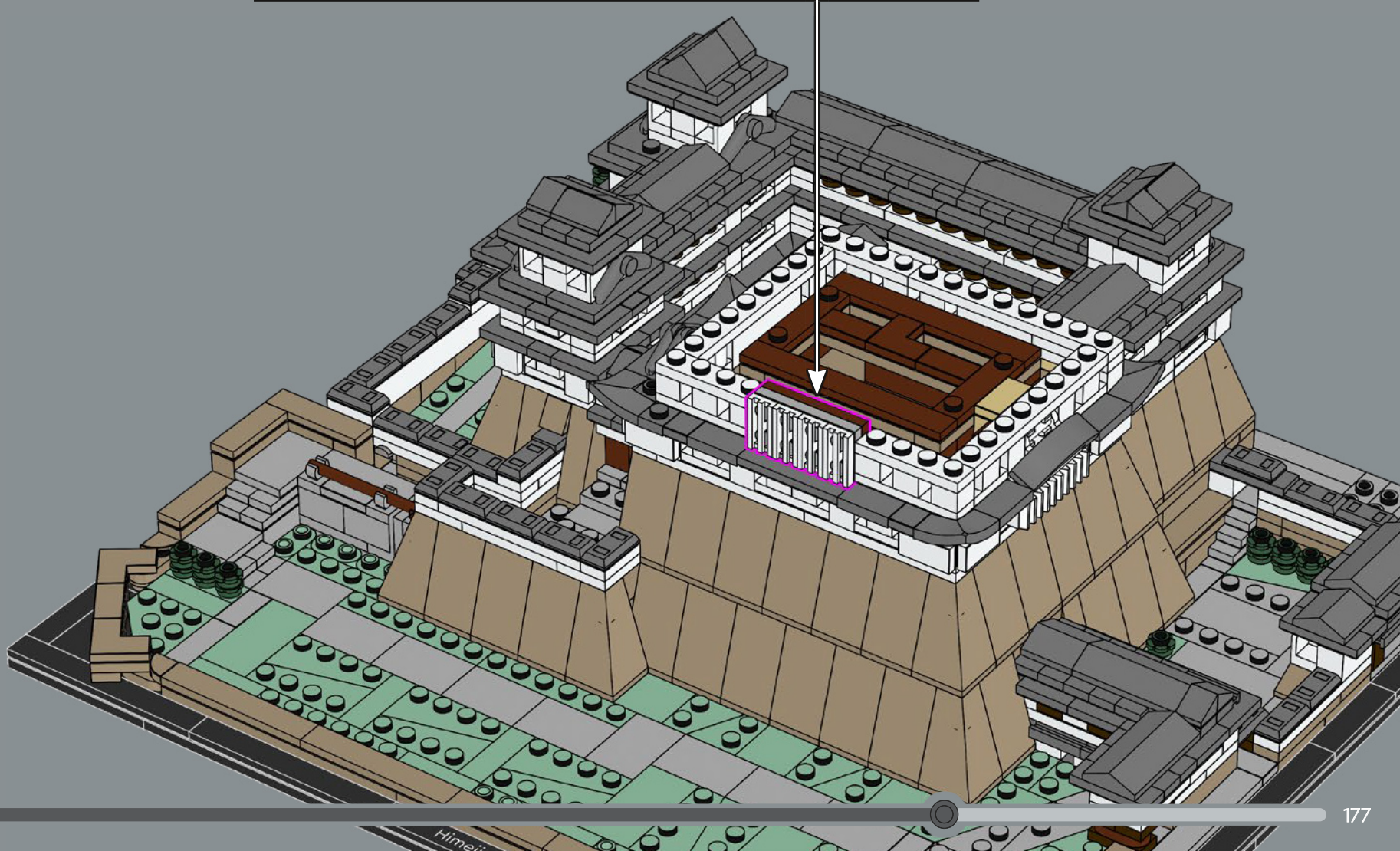
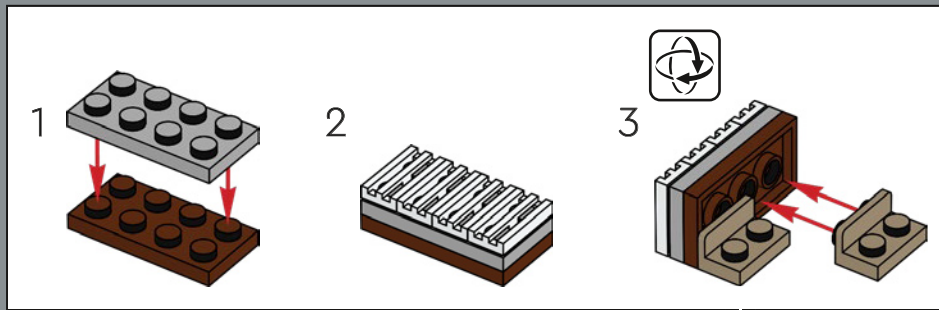



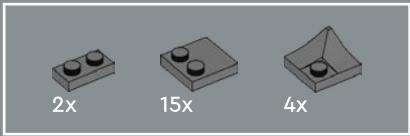

251





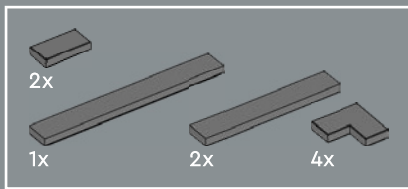

252

Das obere Segment des Bauwerks kann man abnehmen, um den Blick auf einen Teil des Innenlebens freizugeben. Hierzu zählt ein nahezu leerer Ratssaal, der zeigen soll, wie es dort während der Renovierung von 2009 bis 2015 aussah.

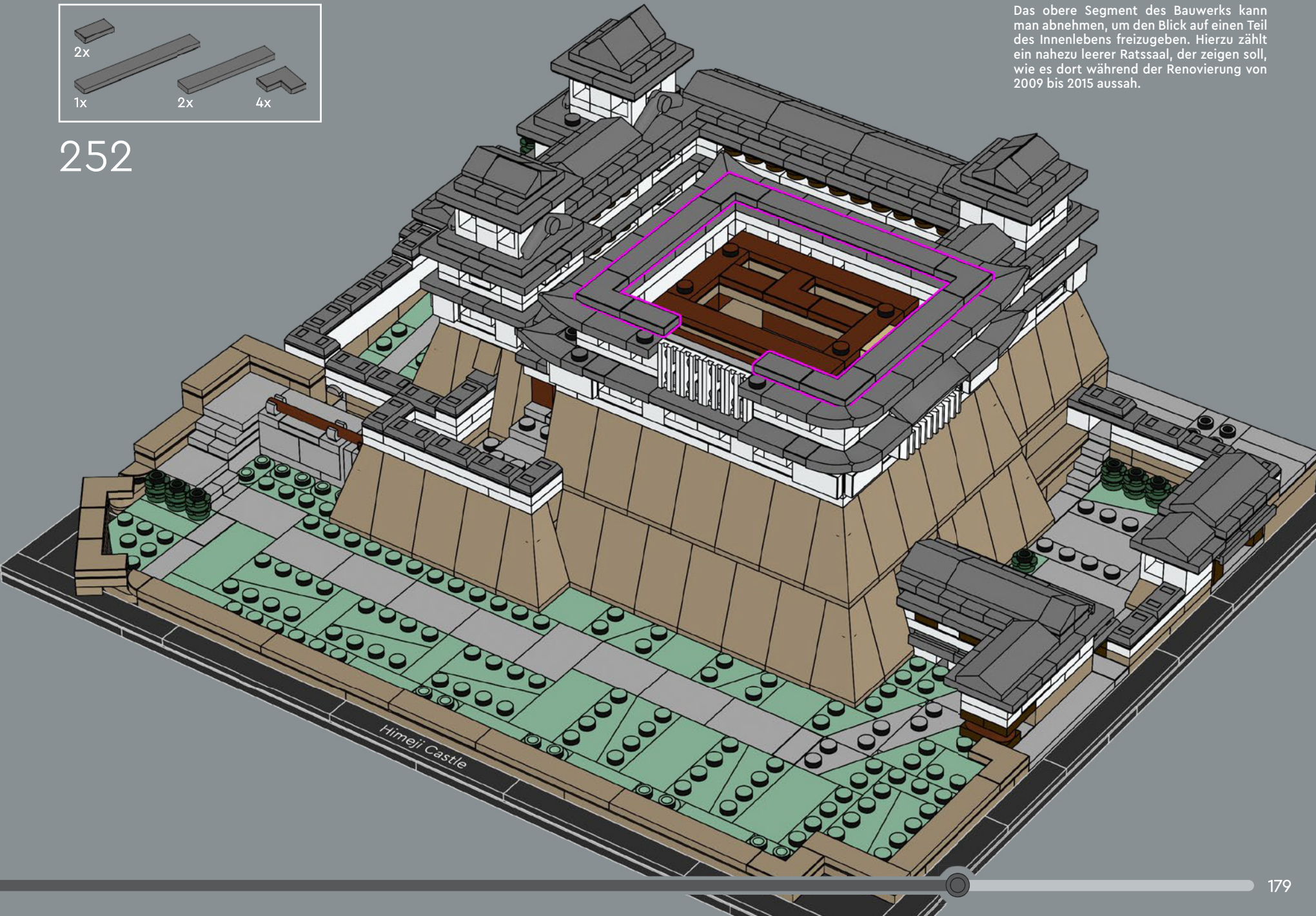

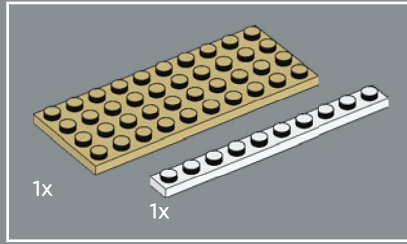
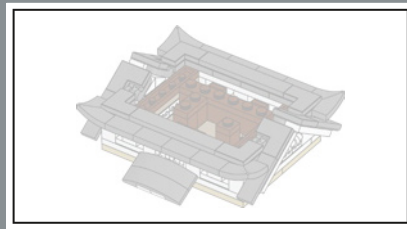

253

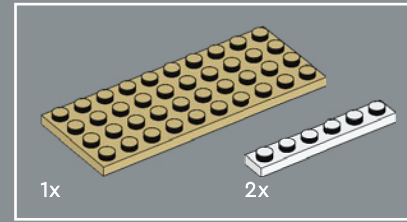
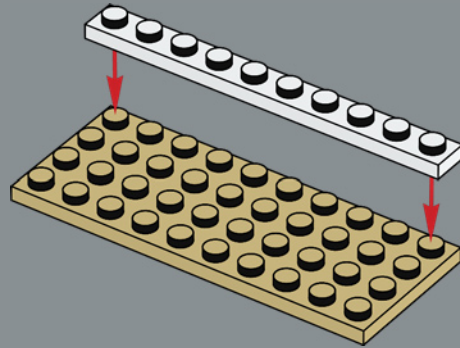

254

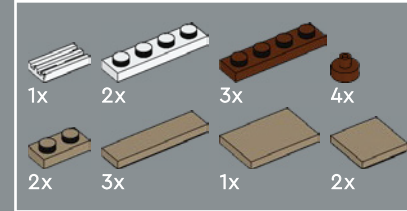
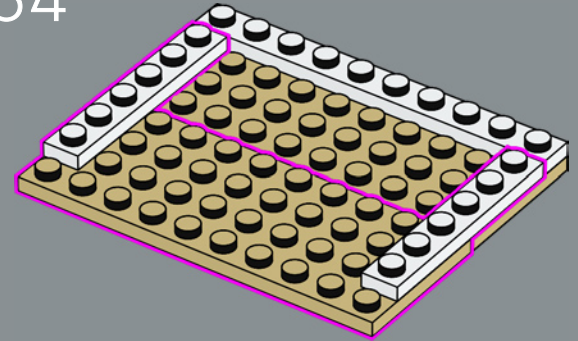

255

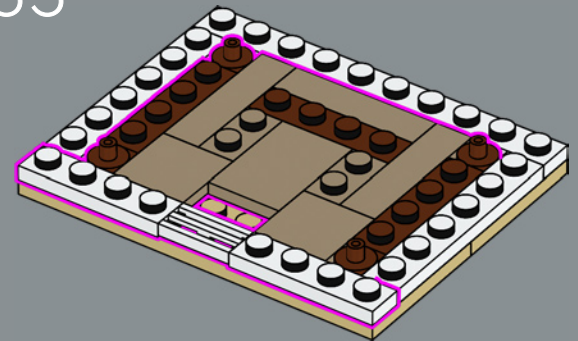



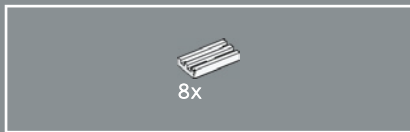

256

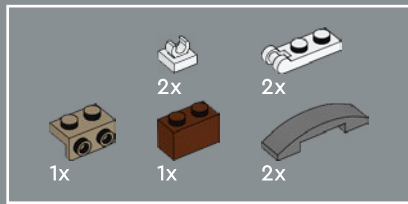
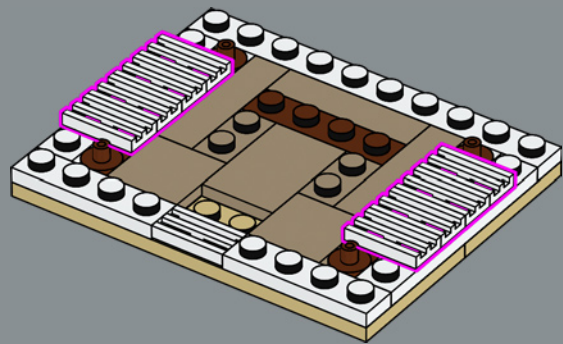

257

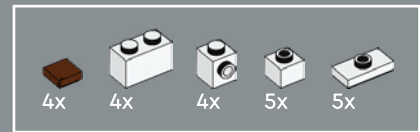
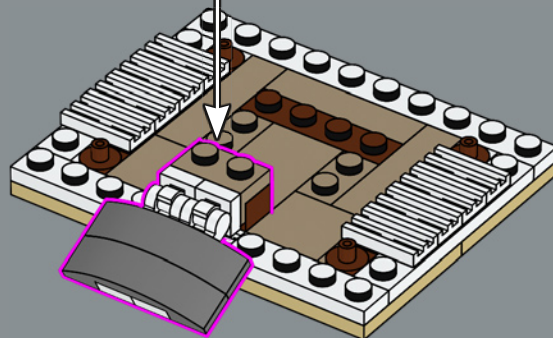
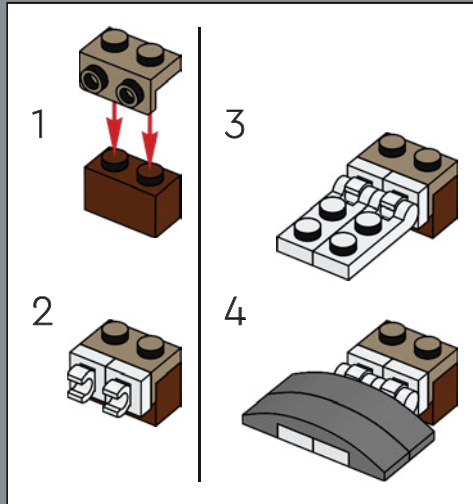

258

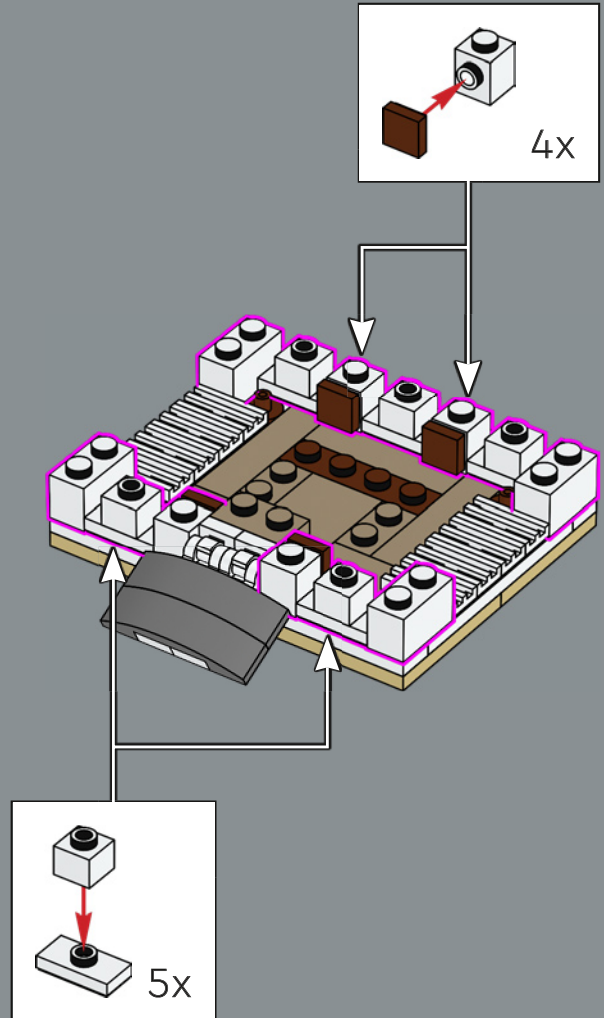

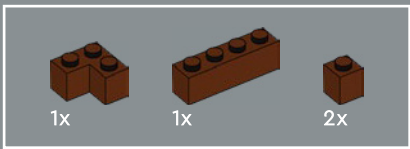

259

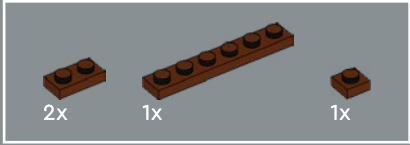
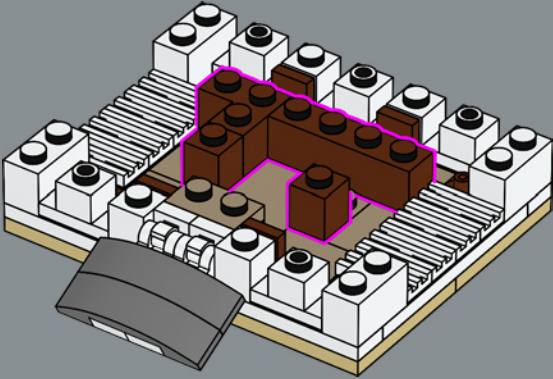

260

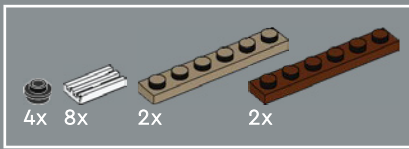
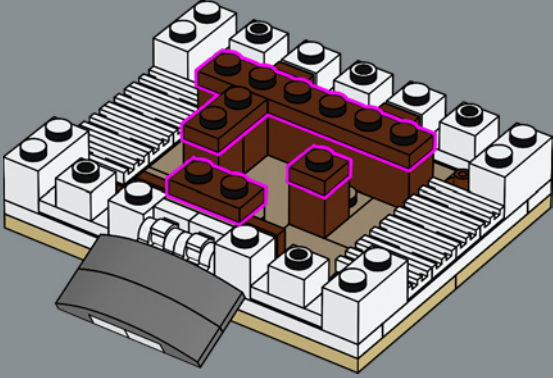

261

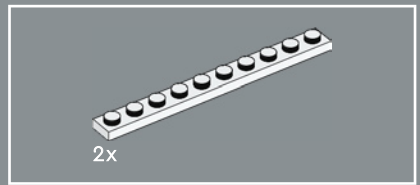
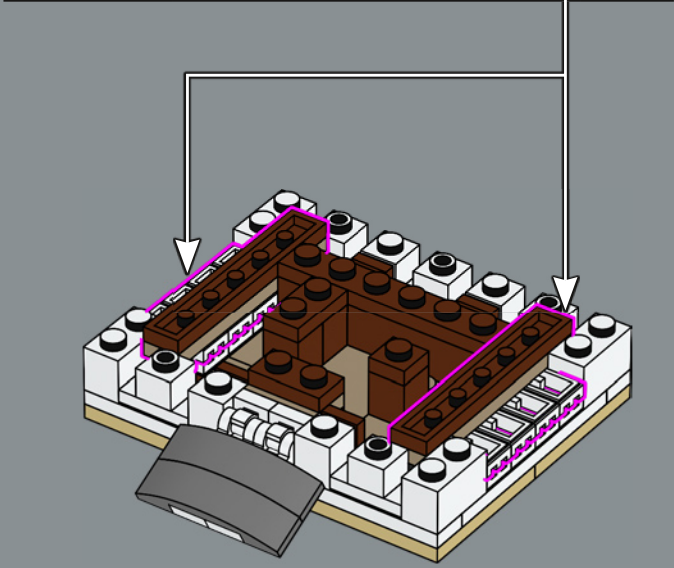
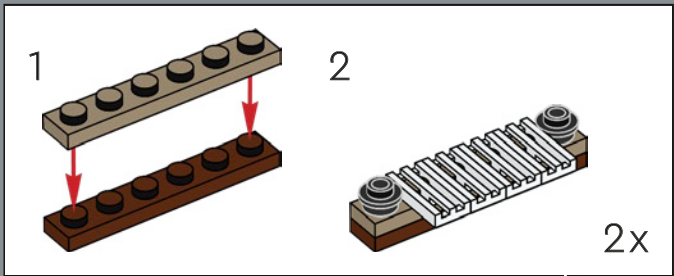

262

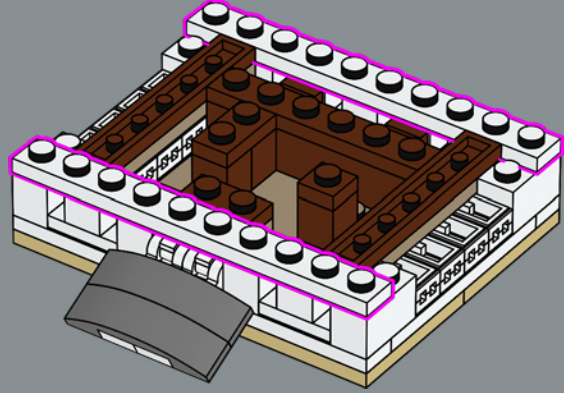



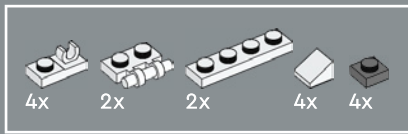

263

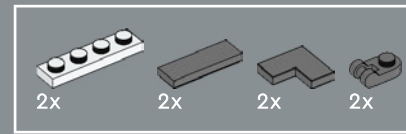
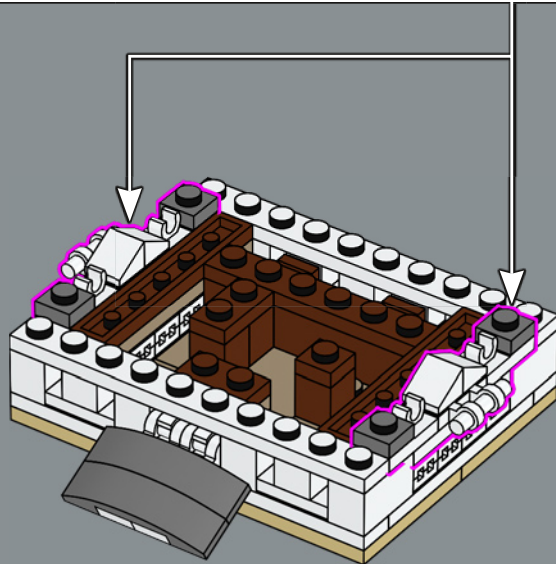
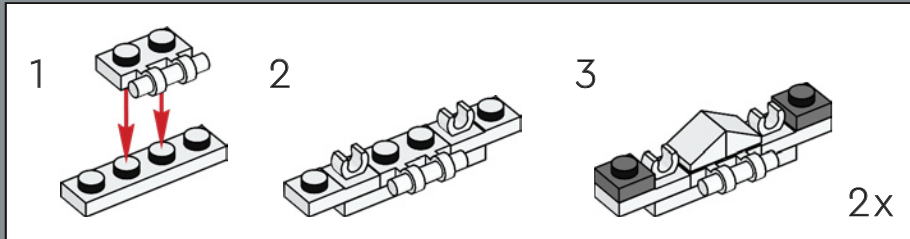

264

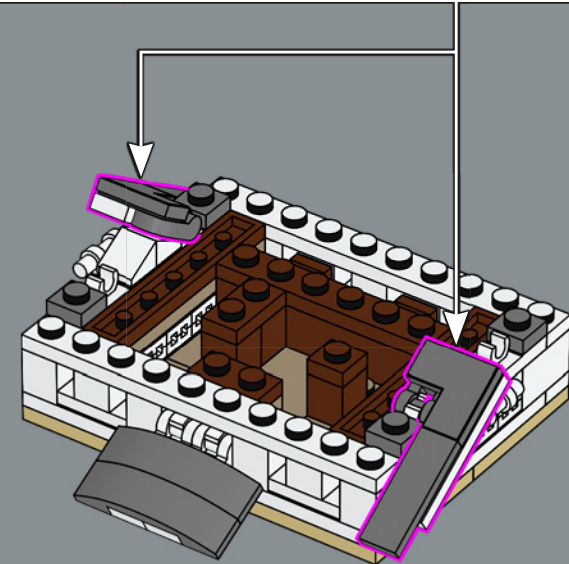
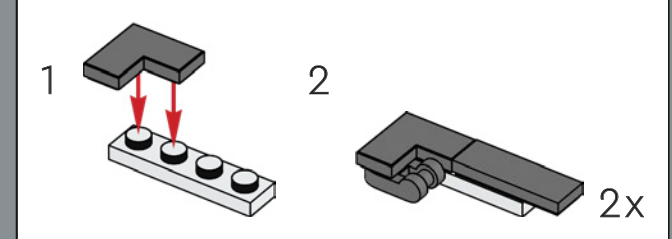

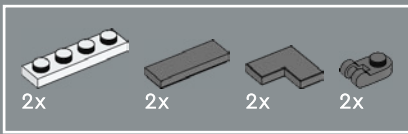

Jede Etage des Hauptburgfrieds hat einen besonderen Grundriss, der auf den Bauplänen der ursprünglichen Burg basiert.

265

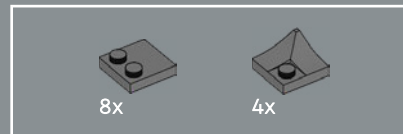
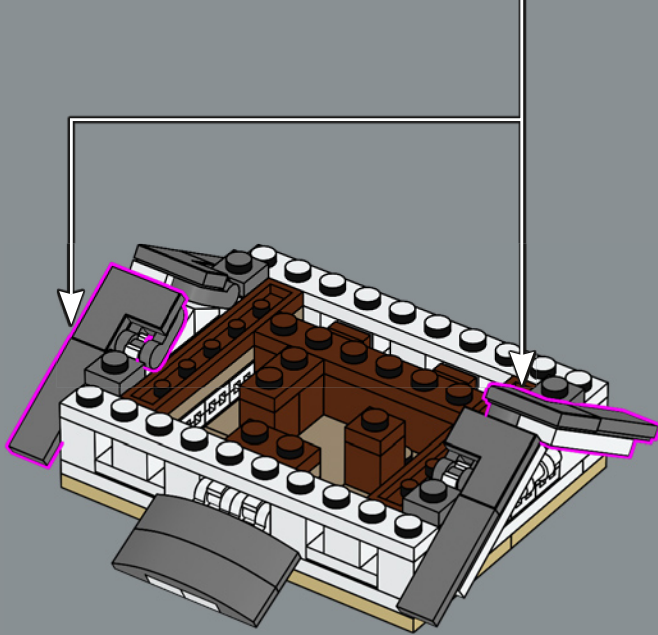
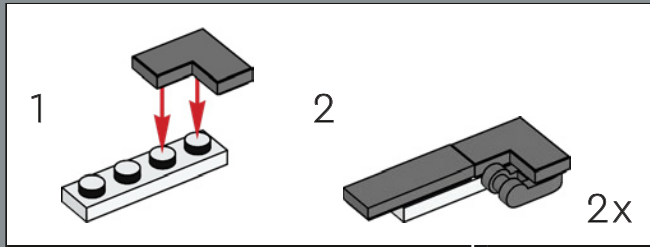

266

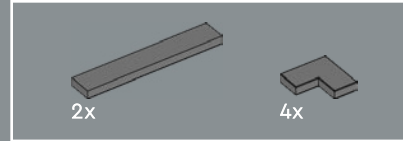
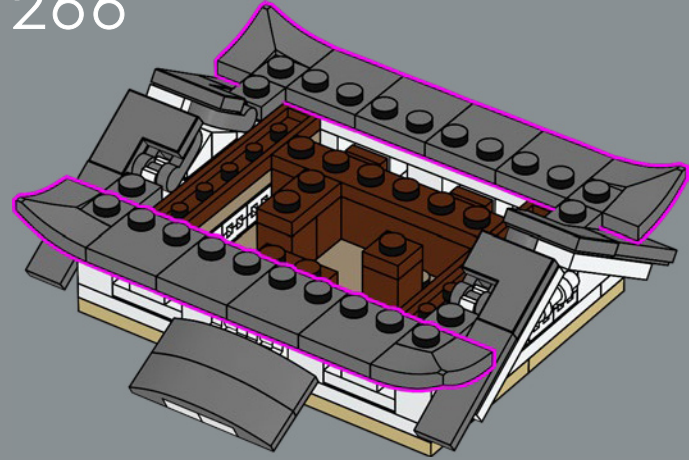

267

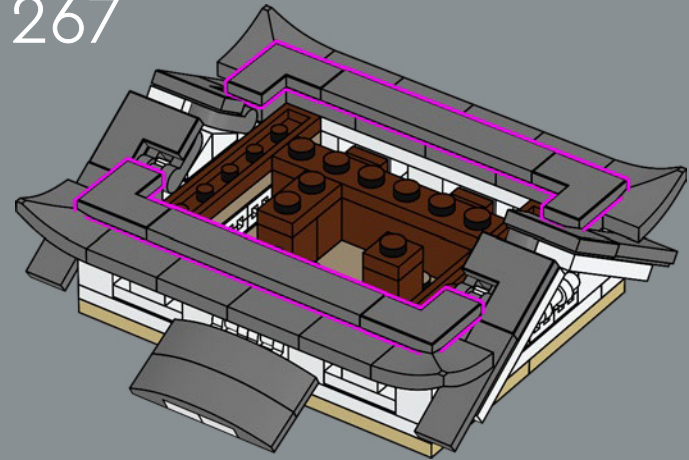



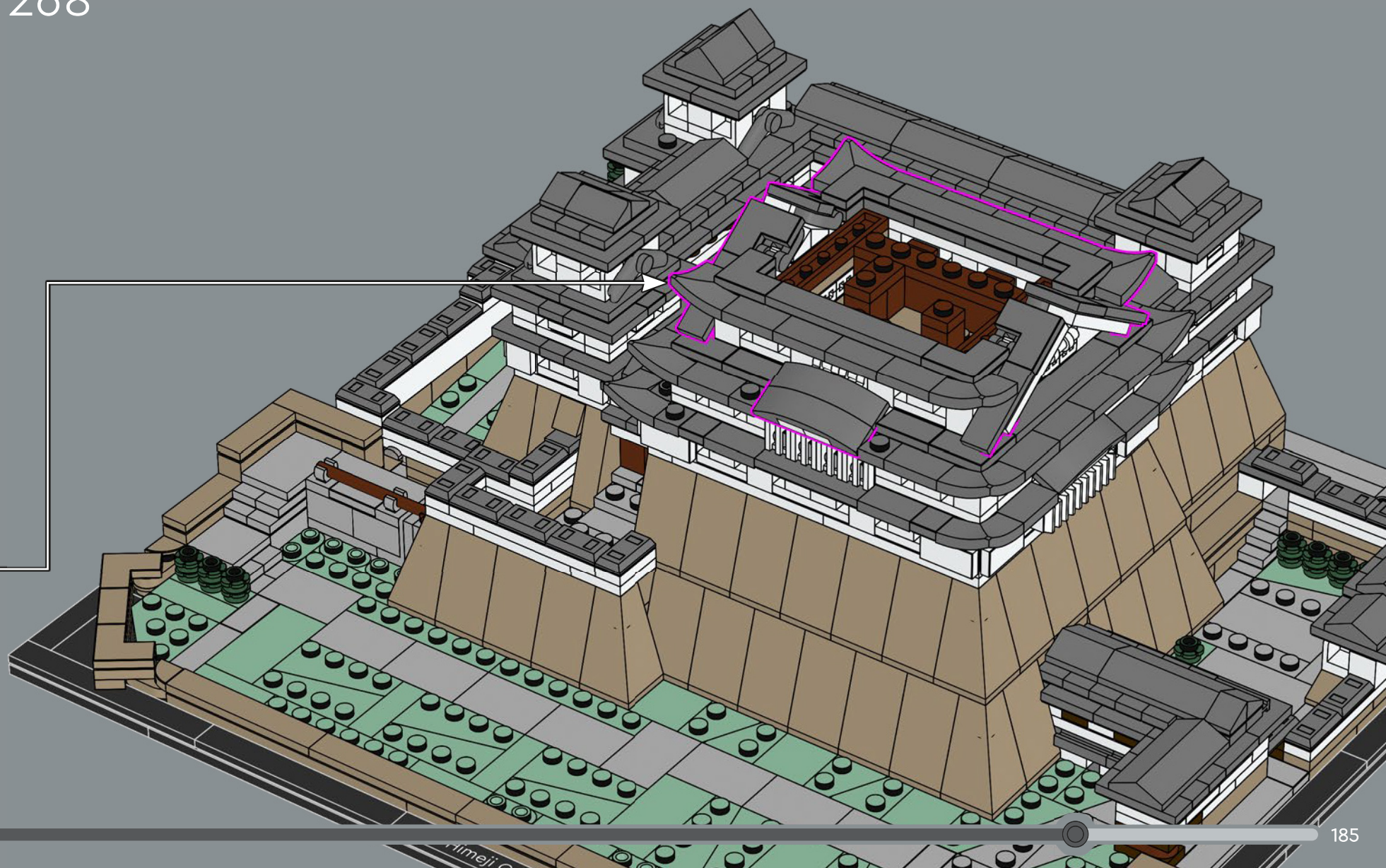





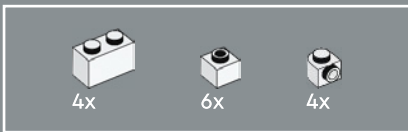

272

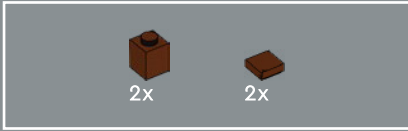
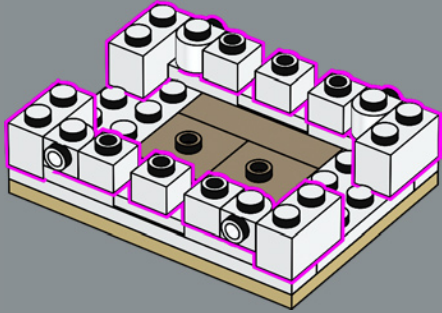

273

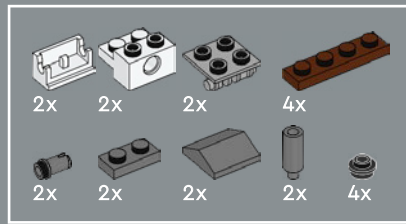
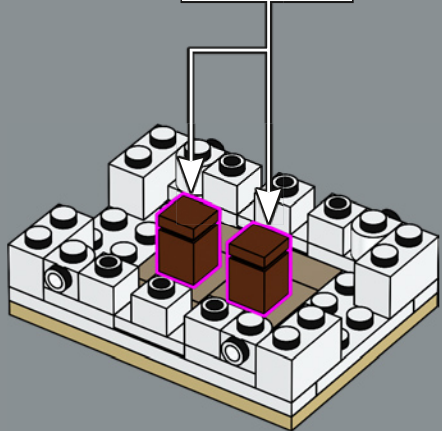
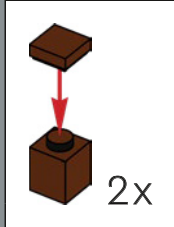

274

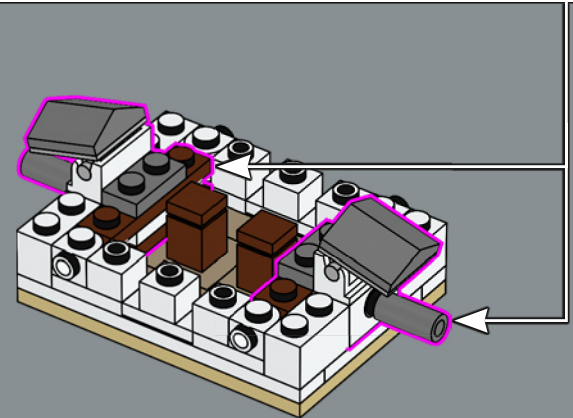
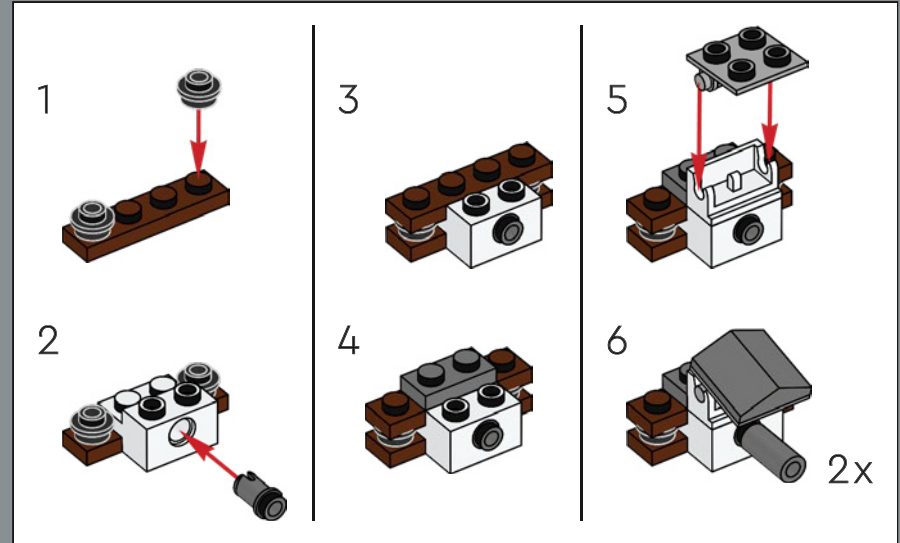

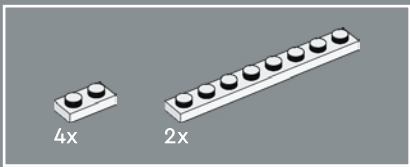

275

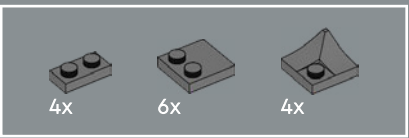
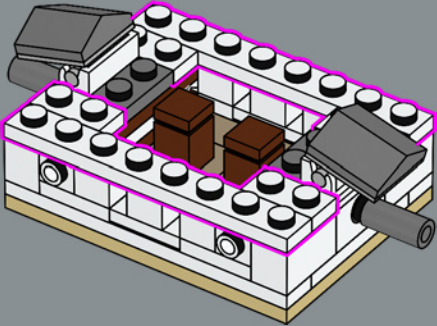

277

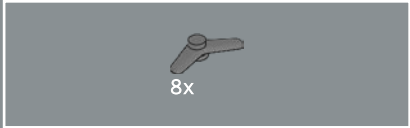
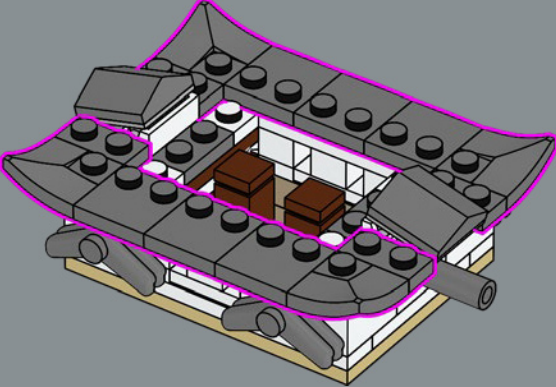

276

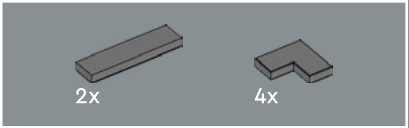
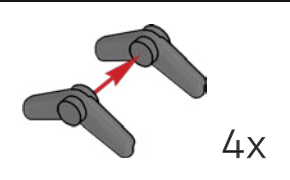
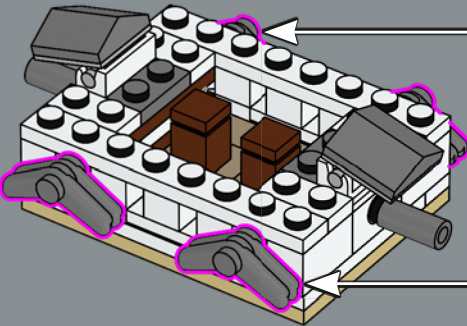

278

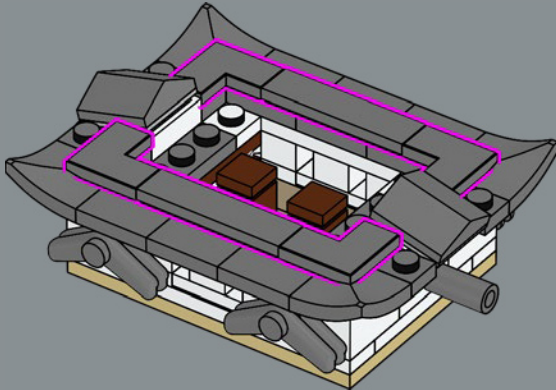



279

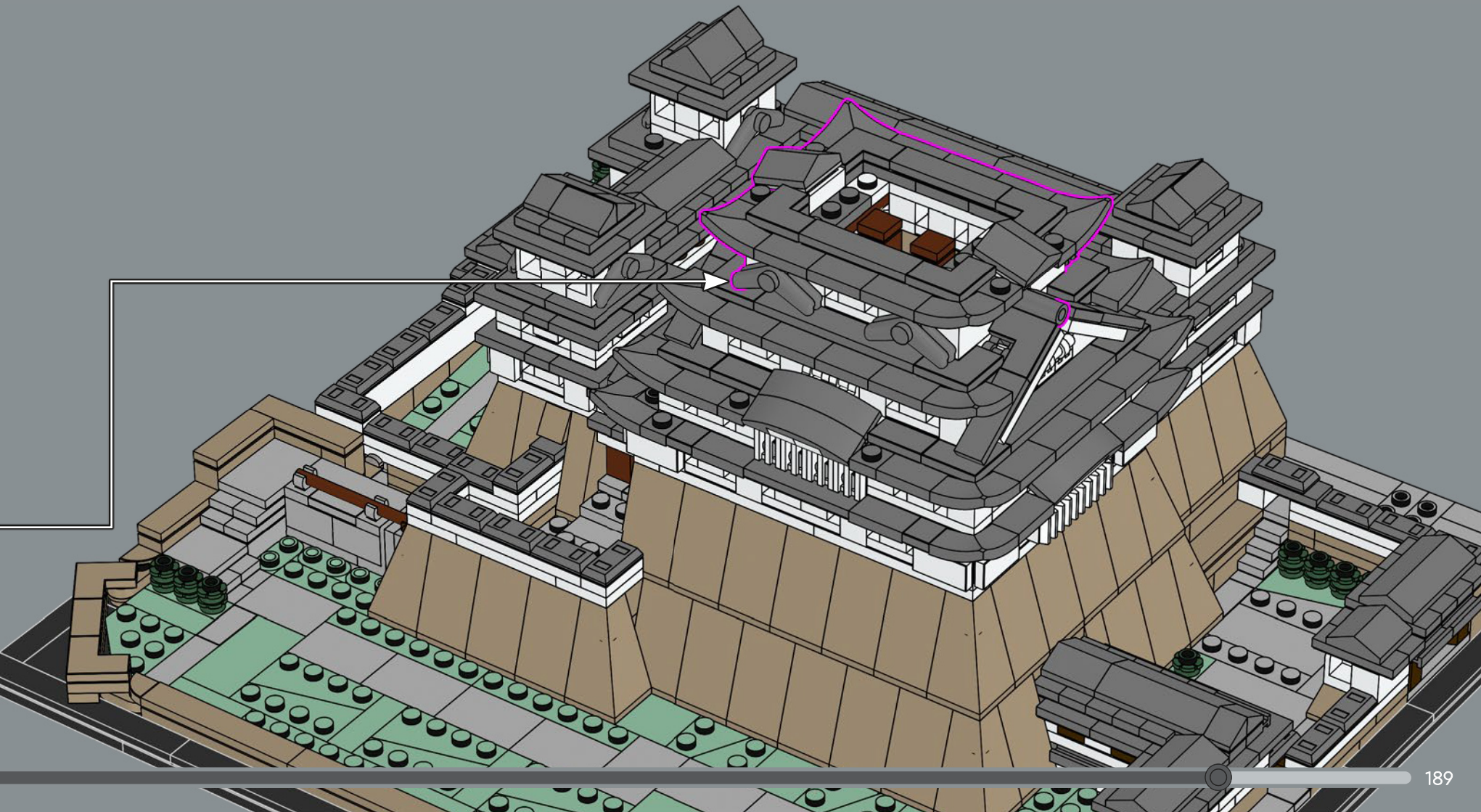





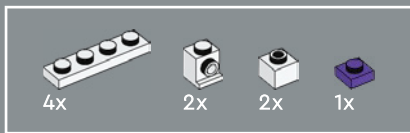

Die violette 1x1 Kachel in der Dachkammer des Hauptburgfrieds soll den kleinen mit einer violetten Gardine verhüllten Holzschrein in diesem Teil der Burg darstellen.

284

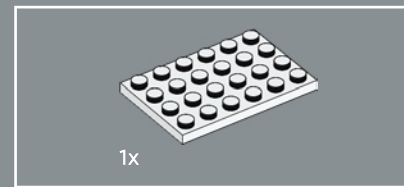
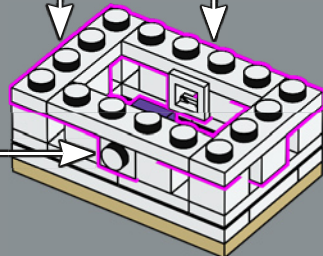
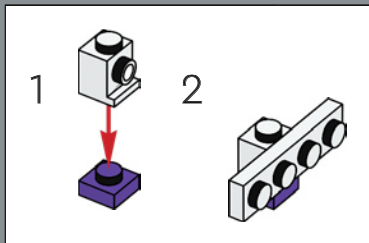
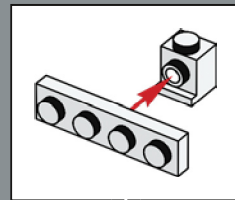
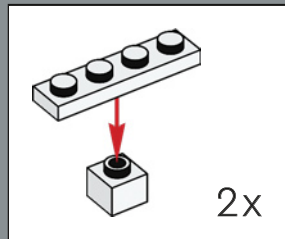

285

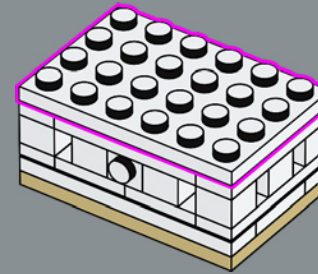

286

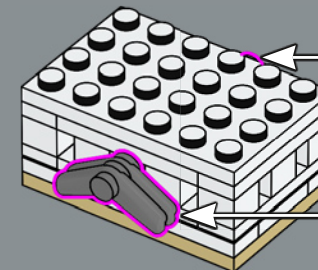
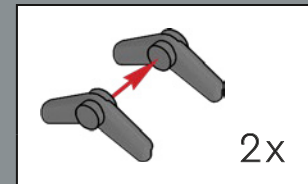

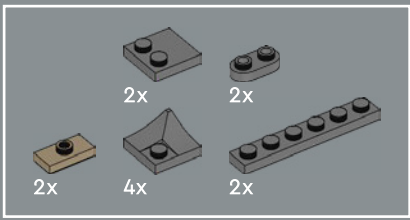

287

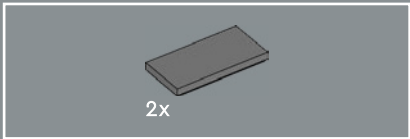
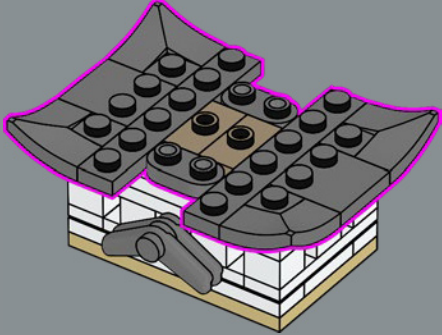

288

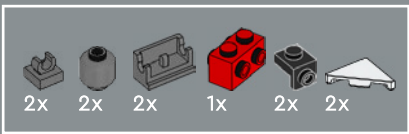
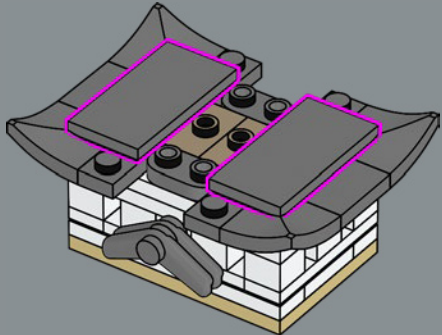

289

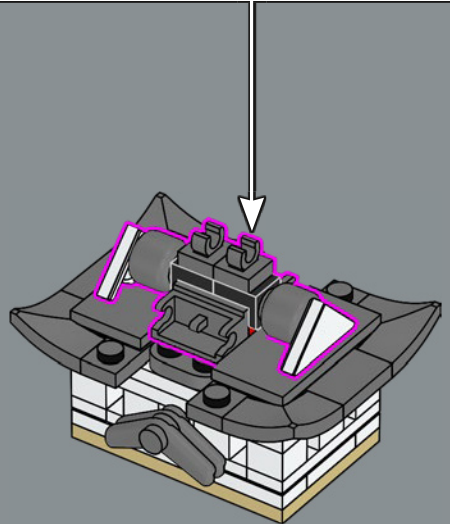
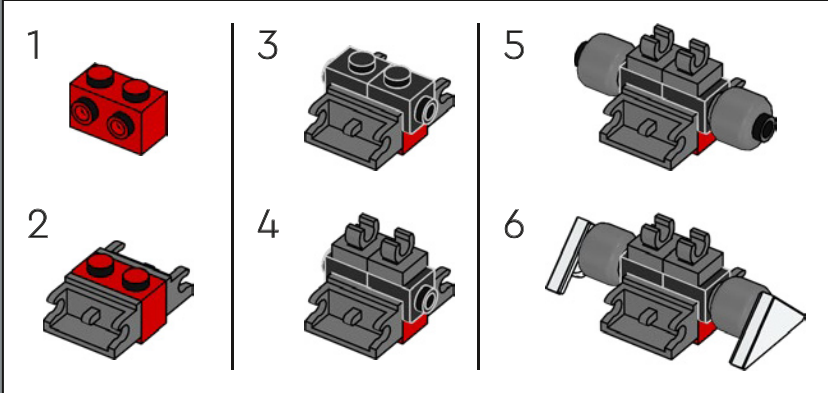



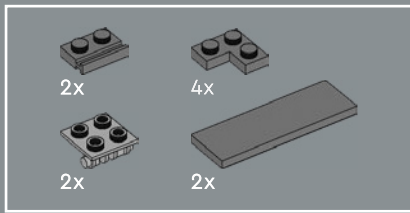

290

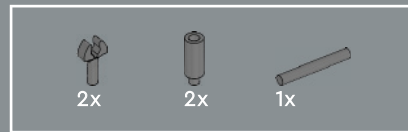
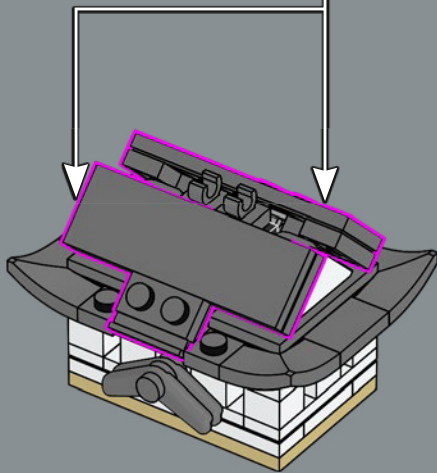
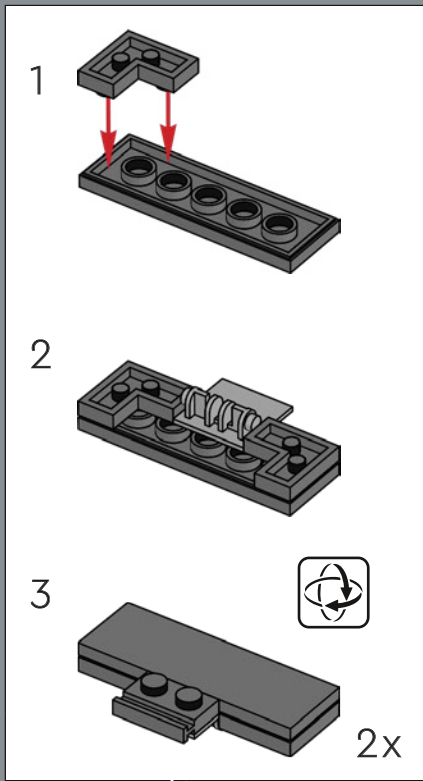

291

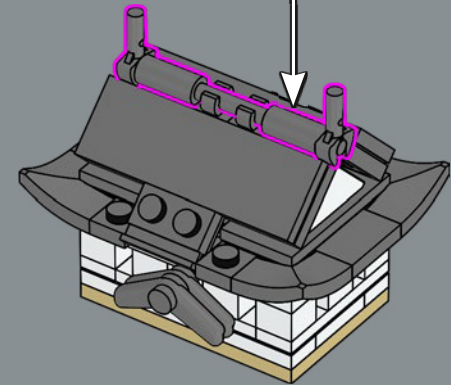
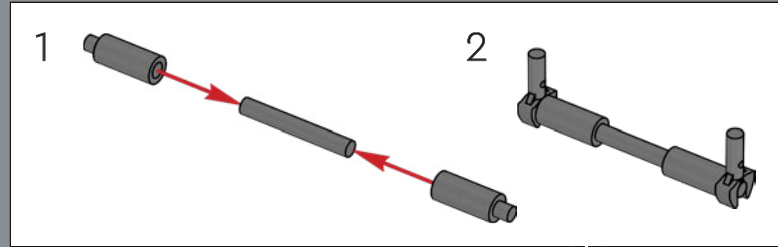

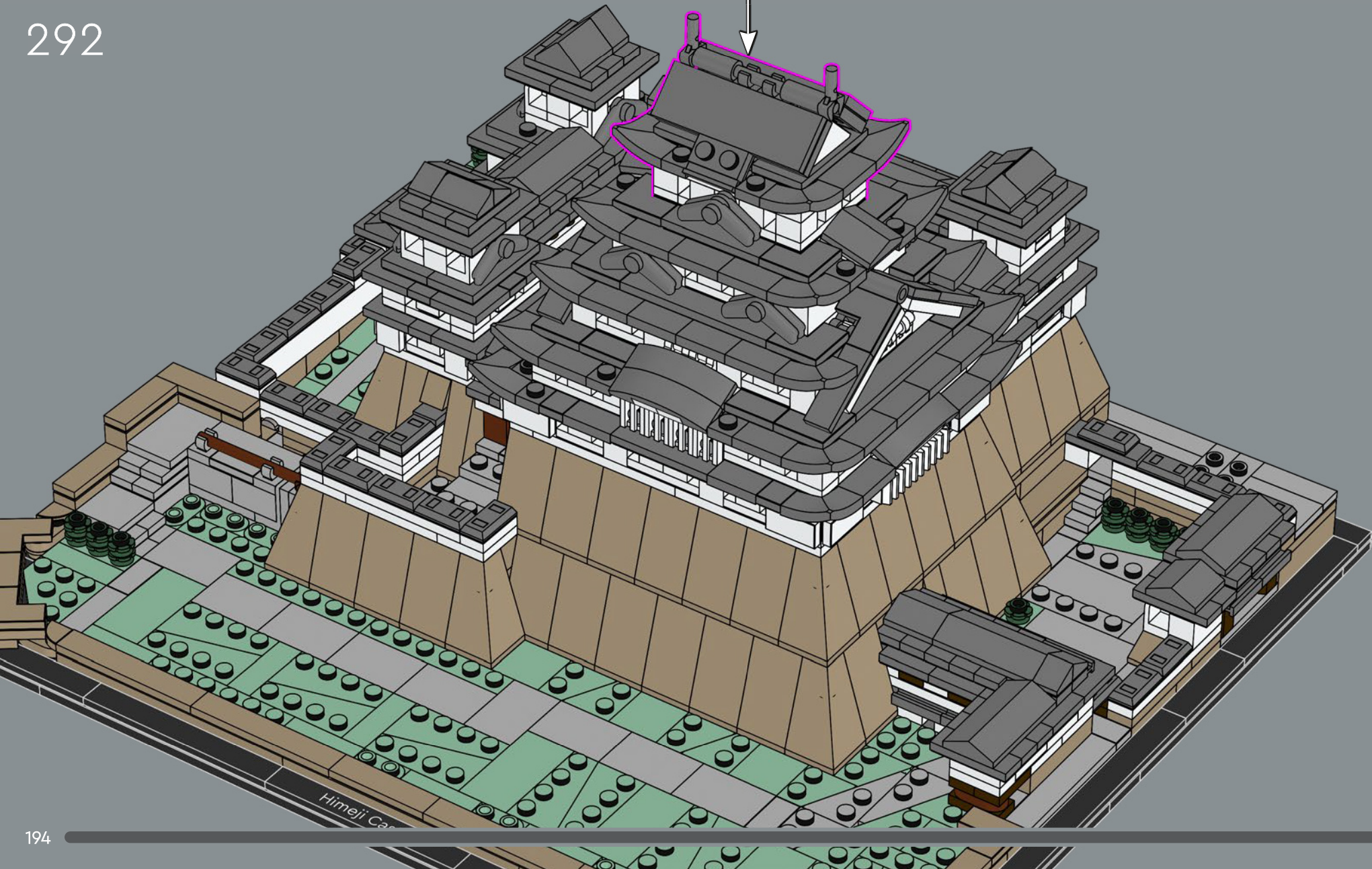

Die Dachziegel des Hauptburgfrieds wurden im Rahmen der Renovierungsarbeiten von 2009 bis 2015 ausgetauscht. Jeder neue Dachziegel ist um 0,75 kg leichter als sein Vorgänger. Insgesamt ist das Dach jetzt also mehr als 45 Tonnen leichter als zuvor!





293

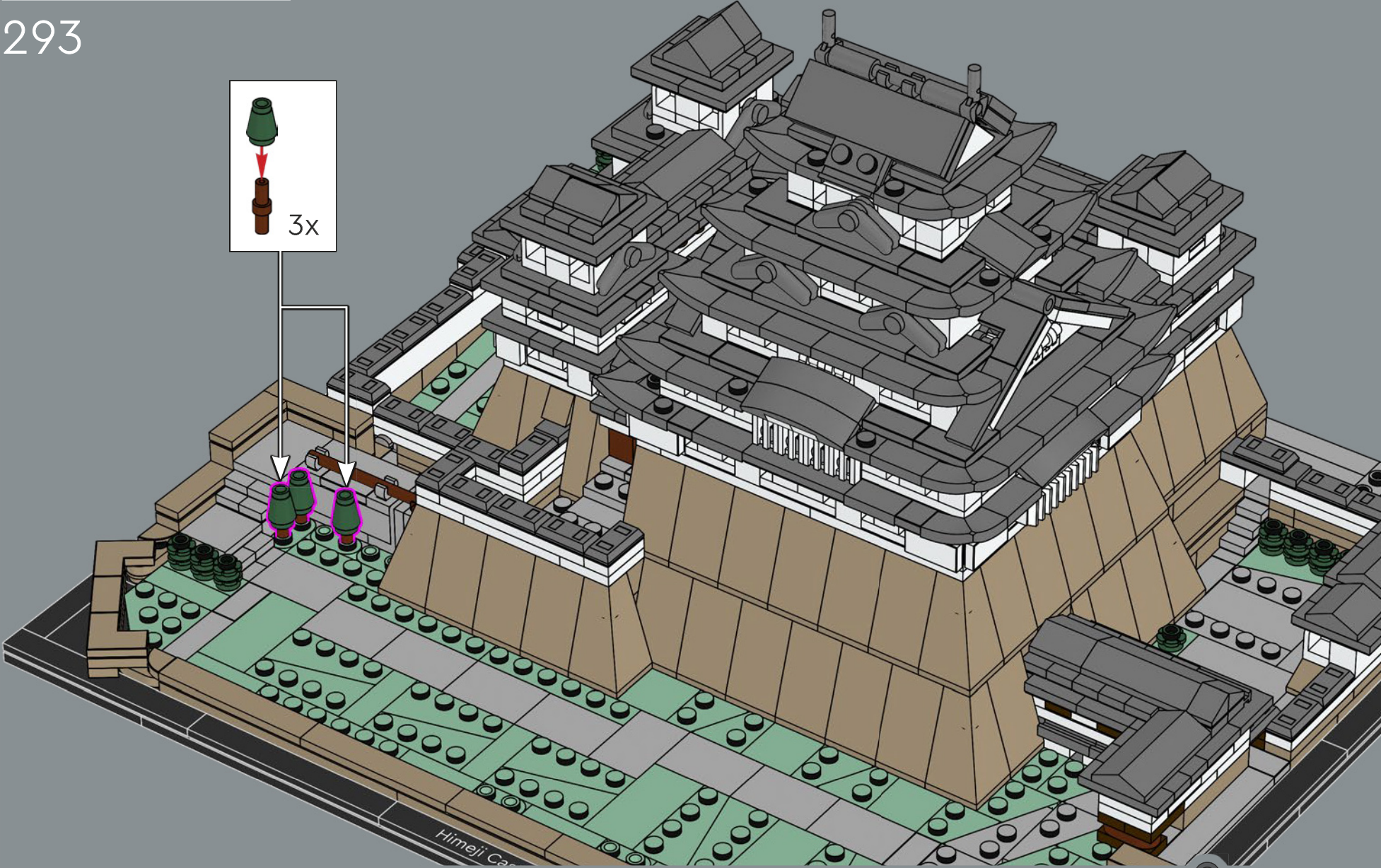
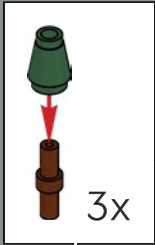

Himeji Castle







294

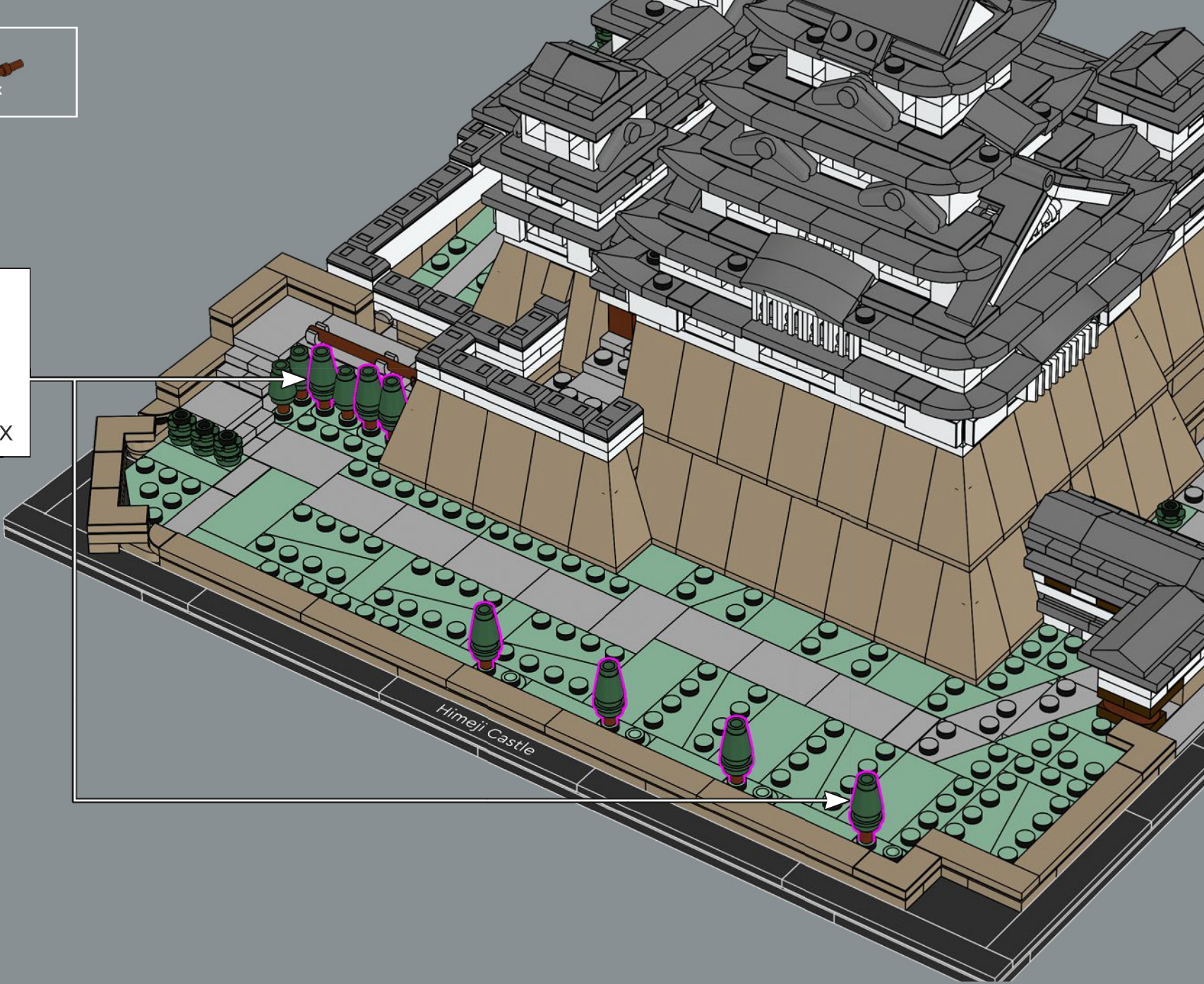
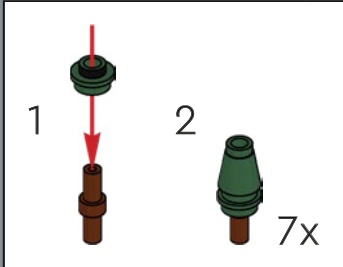



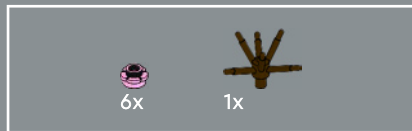

295

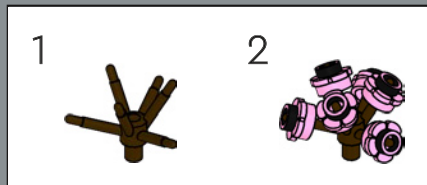



3x

296

3x

Himeji Castle

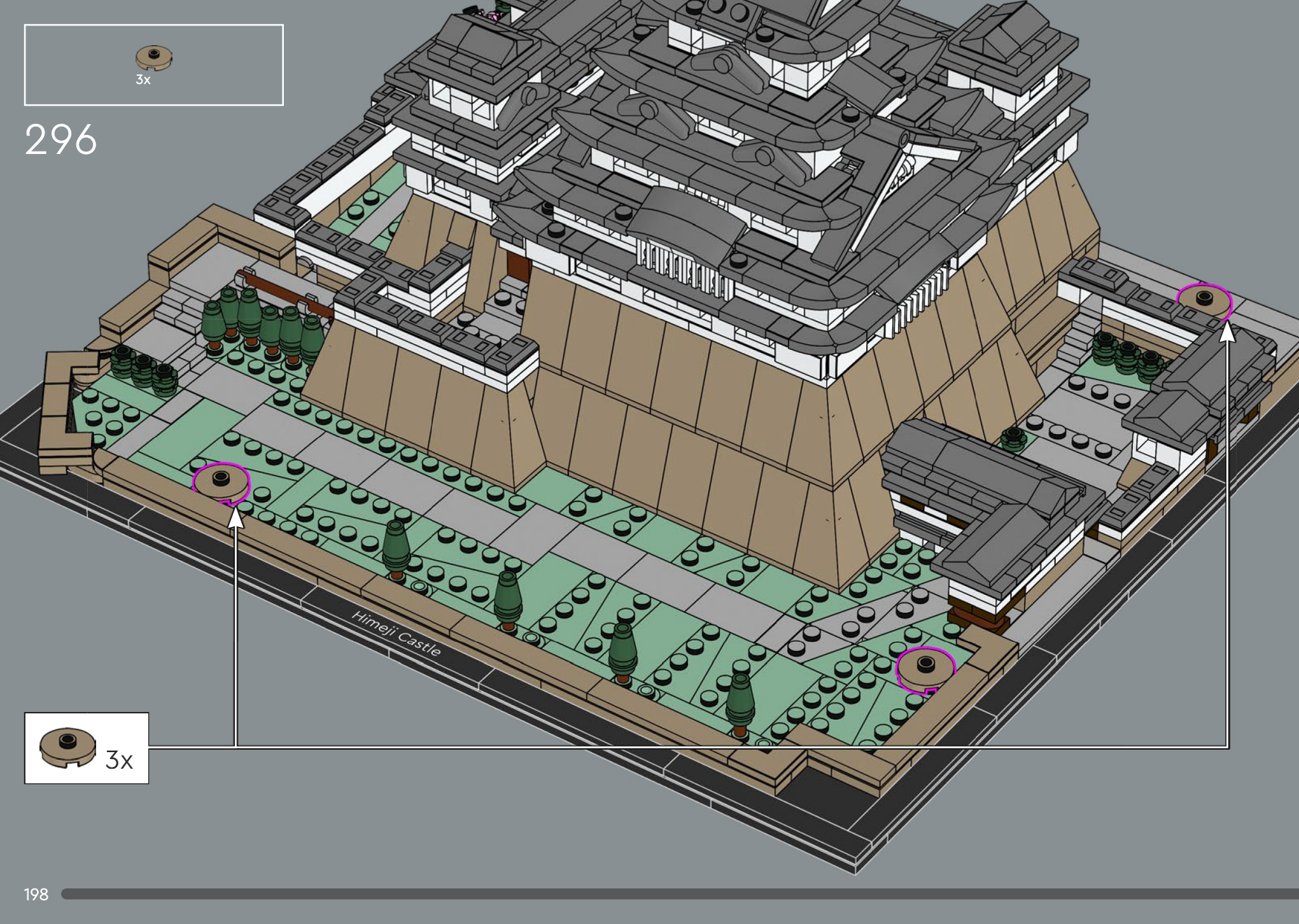



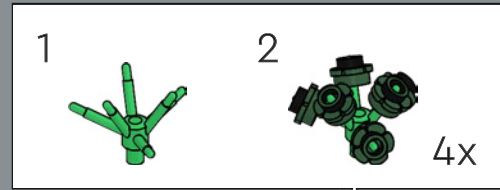
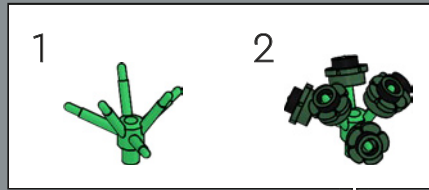
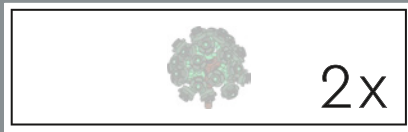

297

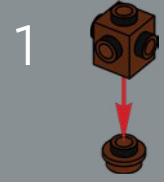



298

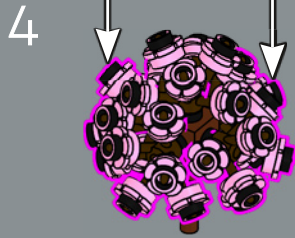
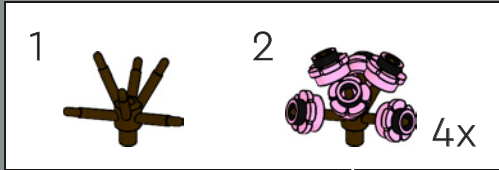
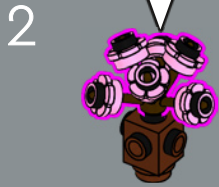
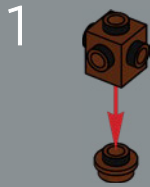
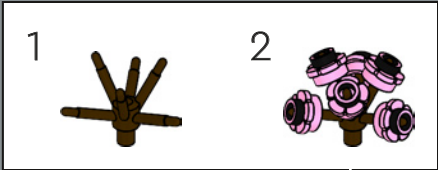







299

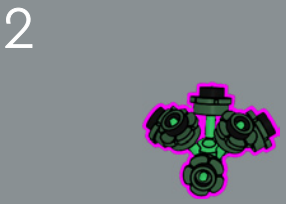
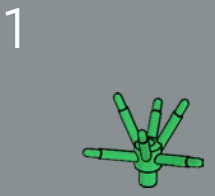
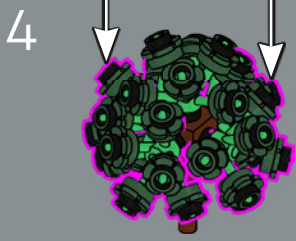
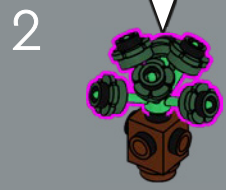
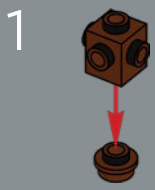
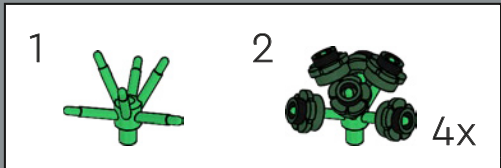
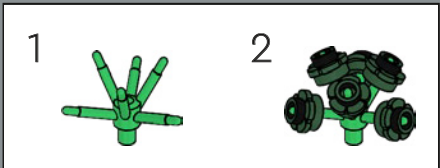



Die Burg Himeji ist auch als Weiße-Reiher-Burg bekannt, weil sie an einen zum Flug ansetzenden Reiher erinnert.

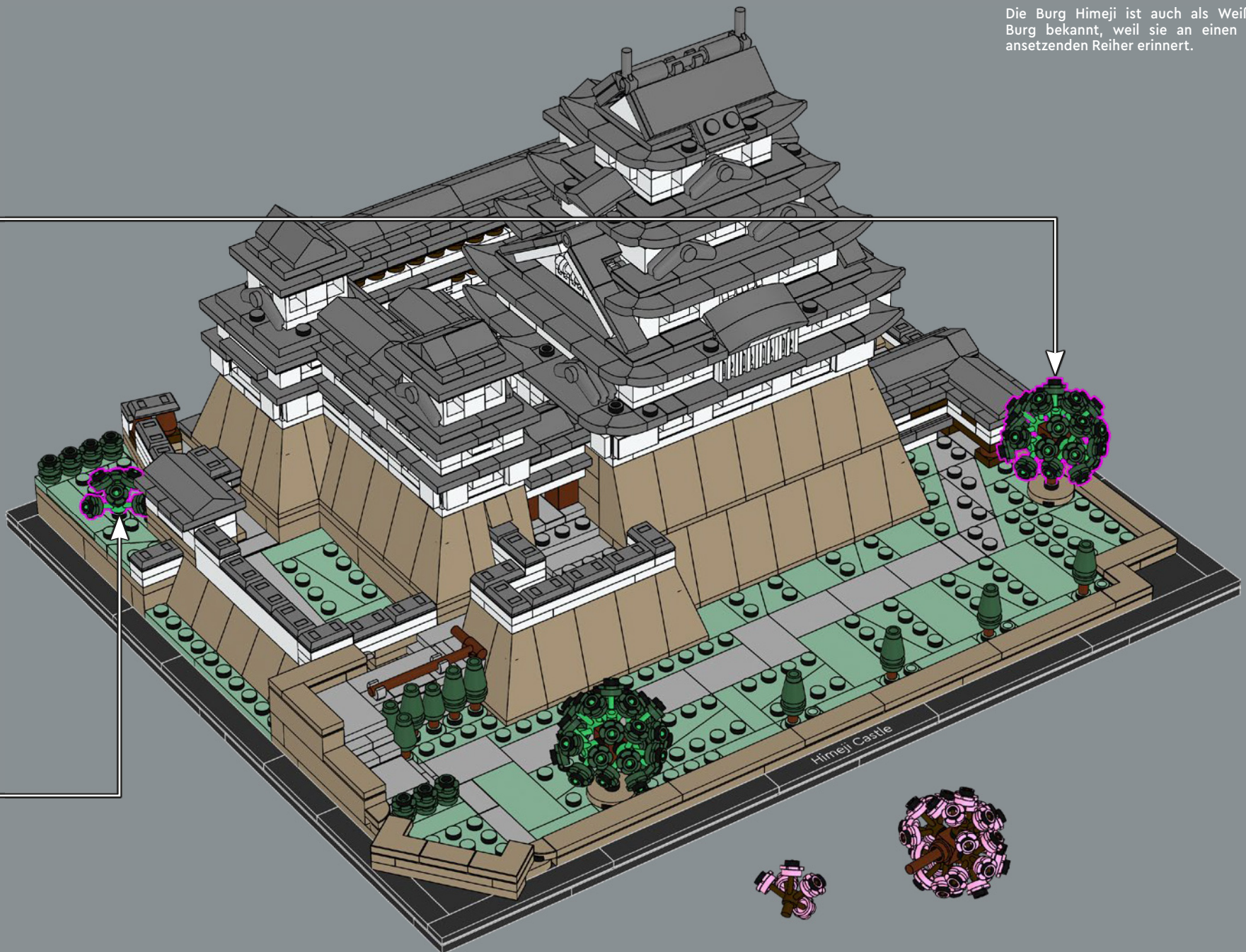

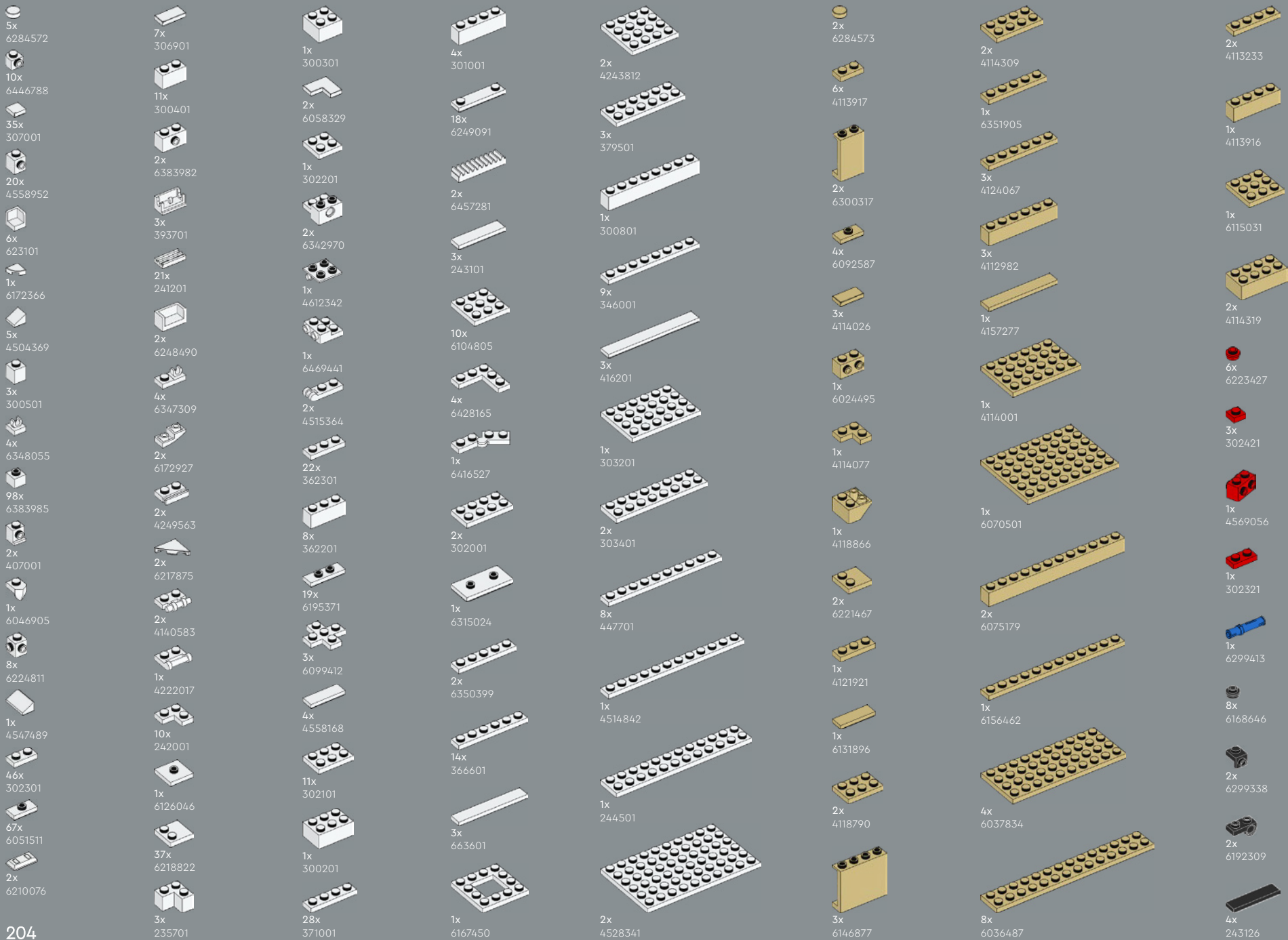



- 2x 302026
- 2x 617926
- 6x 379526
- 15x 416226
- 1x 6454242
- 1x 6454243
- 4x 395826
- 6x 303326
- 11x 6001494
- 1x 300528
- 16x 6269940
- 1x 4181135
- 1x 6240515
- 1x 6300322
- 4x 6273590
- 2x 6040126
- 7x 4549436
- 6x 6001824
- 1x 6055172
- 3x 6362967
- 2x 6231386
- 3x 6132767
- 23x 4528604
- 16x 4521914
- 4x 6092591
- 8x 4653509
- 12x 4496699
- 2x 6250168
- 1x 6328477
- 38x 6000852
- 5x 4616593
- 11x 6436361
- 4x 6398654
- 2x 6047415
- 8x 4255416
- 12x 4550168
- 2x 6310830
- 2x 4507045
- 2x 6126075
- 11x 6132768
- 5x 6015452
- 5x 6035540
- 1x 6328307
- 4x 4626904
- 9x 6175927
- 9x 6001822
- 10x 4247145
- 4x 4267874
- 3x 6164288
- 11x 4507047
- 16x 6015424
- 15x 4247151
- 3x 6156492
- 3x 6167894
- 14x 4246957
- 4x 6232137
- 1x 6096215
- 121x 6446790
- 10x 6411591
- 7x 6230571
- 1x 6099189
- 14x 6247894
- 8x 6303004
- 15x 6258333
- 2x 4616578
- 2x 6184432
- 3x 4655080
- 3x 6133896
- 3x 6423384
- 12x 6202626
- 2x 6069257
- 1x 6416003
- 4x 6100234
- 1x 6192923
- 4x 4633693
- 4x 6099187
- 4x 6186673
- 2x 4529242
- 4x 6215659
- 15x 4211288
- 11x 4211242
- 1x 4221744
- 1x 6348057
- 1x 6214343
- 1x 6238874
- 4x 6133765
- 4x 6248944
- 10x 6451002
- 3x 6261744
- 4x 4211150
- 4x 4211149
- 5x 4211151
- 1x 6092590
- 4x 6428805
- 4x 4211200
- 2x 4211210
- 1x 6221608
- 1x 4565394
- 6x 4508616
- 1x 4211189
- 10x 4211190
- 7x 6257604
- 3x 4211225
- 1x 4211186
- 7x 4221590
- 4x 4211193
- 4x 4216615
- 12x 4585337
- 2x 6313665
- 2x 6055145
- 2x 4211220
- 4x 4211152
- 1x 6251470
- 2x 4211415
- 2x 6308012
- 2x 6306729
- 2x 6163478
- 1x 4211732
- 13x 4211414
- 4x 4211398
- 16x 6066097
- 4x 4211350
- 2x 6092111
- 1x 4654580
- 2x 6065824

- 1x 6126082
- 1x 4211397
- 2x 4211349
- 1x 4211413
- 4x 4211881
- 1x 6438836
- 12x 4558169
- 12x 6211969
- 3x 4211429
- 16x 6171894
- 2x 4211356
- 5x 6257593
- 2x 4211445
- 5x 4560183
- 2x 4211395
- 1x 4211385
- 2x 4211549
- 4x 4211795
- 5x 4211481

- 1x 4211407
- 4x 4211408
- 6x 4211405
- 6x 4662161
- 4x 6058221
- 6x 6452882
- 1x 6252667
- 2x 6226792
- 1x 6223039
- 36x 6212501
- 4x 6388120
- 4x 4529240
- 2x 6439040
- 1x 4211407
- 4x 4211408
- 6x 4211405
- 4x 6058221
- 6x 6452882
- 1x 6252667
- 2x 6226792
- 1x 6223039
- 36x 6212501
- 4x 6388120
- 4x 4529240
- 2x 6439040

- 2x 6192569
- 2x 6395635
- 4x 4210848
- 9x 4210719
- 2x 6344022
- 6x 4504378
- 2x 6199549
- 2x 6221607
- 4x 6388119
- 1x 4226221
- 6x 4567887
- 29x 6331866
- 20x 6092572
- 12x 4211063
- 6x 4211052
- 2x 4211066
- 2x 4211135

- 3x 6000606
- 9x 4543086
- 20x 6446785
- 1x 6310596
- 12x 6126083
- 6x 6446786
- 1x 4211094
- 43x 6309059
- 2x 4210702
- 18x 6247784
- 1x 6232193
- 21x 6447212
- 4x 4210635
- 1x 4211055
- 60x 6343852
- 8x 4568734

- 1x 4211043
- 3x 6187008
- 4x 4211053
- 3x 4648256
- 2x 6039176
- 41x 6307616
- 6x 4560184
- 3x 4211127
- 10x 6189120
- 4x 4210651
- 2x 4211056
- 2x 6321746
- 1x 6230281

- 2x 4210998
- 1x 4211008
- 1x 4210997
- 1x 4211061
- 2x 6133611
- 1x 6000970
- 1x 6231376
- 2x 6215447
- 3x 6093529
- 25x 6315780
- 3x 6259071
- 4x 6194729
- 3x 4519970



[LEGO.com/service](https://www.LEGO.com/service)





# YOU COULD WIN



## YOU COULD WIN

Your feedback will help shape the future development of this product series.

Visit:

## DU KÖNNTEST GEWINNEN

Dein Feedback trägt zur Weiterentwicklung dieser Produktreihe bei.

Geh auf:

## VOUS POURRIEZ GAGNER

Vos commentaires nous aideront à concevoir les futurs produits de cette gamme.

Visitez :

## POTRESTI VINCERE TU

La tua opinione ci aiuterà a migliorare la creazione futura di questa linea di prodotti.

Visita:

## PUEDES GANAR

Tu opinión contribuirá al futuro de esta serie de productos.

Visita:

## 轻松获奖

您的反馈将有助于我们在今后改进本产品系列。

请访问:

---

[LEGO.com/productfeedback](https://www.lego.com/productfeedback)

---

You also have the chance to win a LEGO® set.

Terms and conditions apply.\*

Außerdem hast du die Chance, ein LEGO® Set zu gewinnen.

Es gelten die Teilnahmebedingungen.\*

Vous pourriez également gagner un ensemble LEGO®.

Des conditions s'appliquent.\*

Hai anche la possibilità di vincere un set LEGO®.

Termini e condizioni sono applicabili.\*

También tienes la oportunidad de ganar un set LEGO®.

Aplican términos y condiciones.\*

您还有机会赢取乐高®套装。

条款和条件适用。\*

\*[LEGO.com/productfeedback-terms](https://www.lego.com/productfeedback-terms)

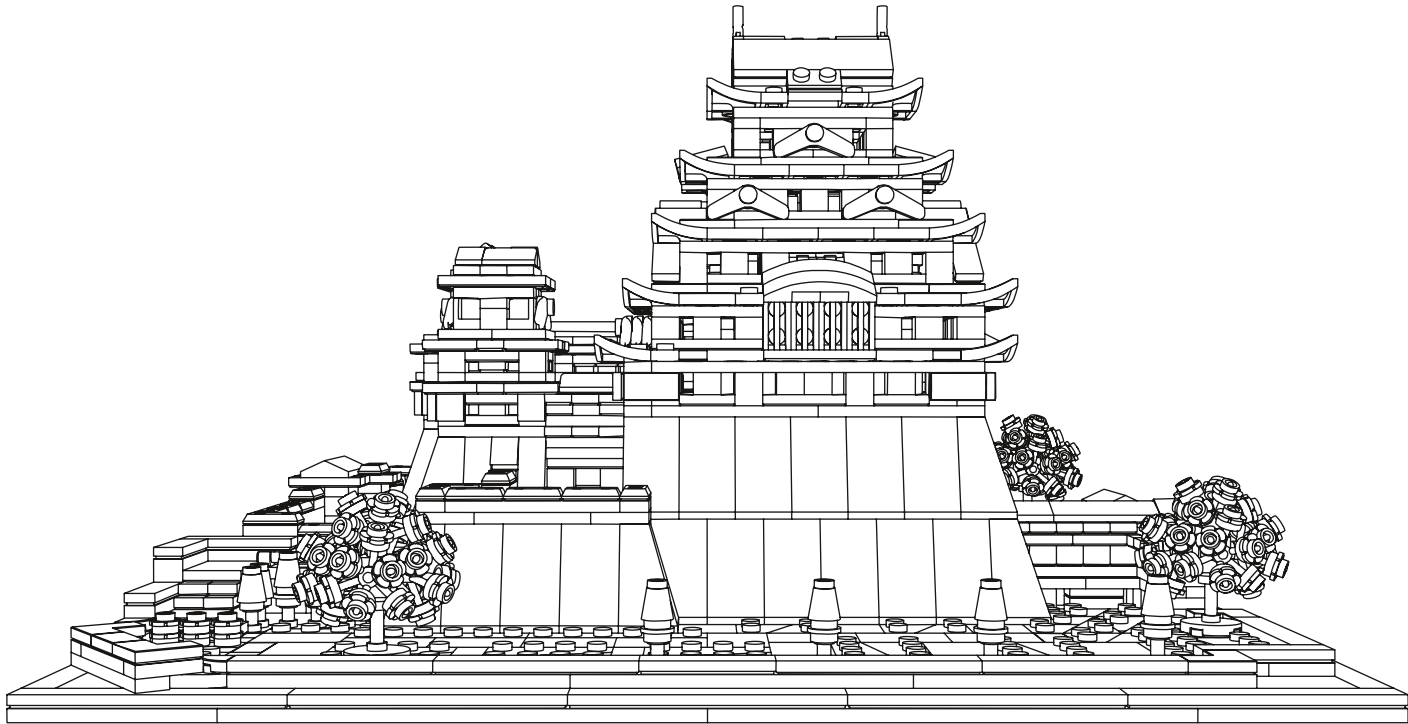

LEGO and the LEGO logo are trademarks of the LEGO Group. ©2023 The LEGO Group.

Adam Reed Tucker is the co-developer of the LEGO® Architecture product line.